



# 06.1



# GRAPAS

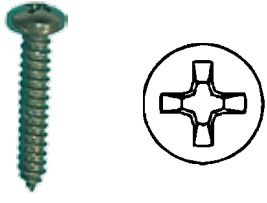

	<u>Pags.</u>
UNIVERSALES	
Tornillos	2 a 5
Universales metálicas	6
Clips metálicos	7 a 9
Remaches metálicos y botón fijación universal	10
Tacos plásticos	11 a 13
Remaches plásticos	14 a 23
Botones de fijación plásticos	24 a 27
Varios	28
Abrazaderas plástico	29
Reguladores faro	30 a 31
Bombas lavacristales	32 a 33
Tubos empalmes	34
Expositores	35
ALFA ROMEO	ver FIAT
AUDI	ver V.A.G.
B.M.W.	36 a 44
CITROEN	ver P.S.A.
DACIA	45 a 46
DAEWOO	47
DAHIATSU	47
FIAT	48 a 69
FORD	70 a 82
HONDA	83 a 85
HYUNDAI / KIA	86 a 87
LANCIA	ver FIAT
LEXUS	88 a 89
MAZDA	90
MERCEDES	91 a 99
MINI	100 a 102
MITSUBUSHI	103
NISSAN	104 a 105
OPEL	106 a 115
PEUGEOT	ver P.S.A.
P.S.A.	116 a 135
RENAULT	136 a 160
ROVER	161
SEAT (hasta pertenecer al grupo V.A.G.)	162 a 166
SEAT (desde pertenecer al grupo V.A.G.)	ver V.A.G.
SKODA	ver V.A.G.
SMART	167
SUBARU	167
SUZUKI	168
TOYOTA	169 a 173
V.A.G.	174 a 201
VOLKSWAGEN	ver V.A.G.
VOLVO	202 a 204
INDICE por referencia Adaptable	205 a 217
INDICE por referencia TRICLO	218 a 239
INDICE por Eurocode	240

# TORNILLOS varios

		<b>DIN 7981 (color negro)</b>	
Medidas			U.E.
mm.	"		
2,9 x 16	4x5/8	<b>161.500</b>	50
3,5 x 13	6x1/2	<b>161.501</b>	50
3,5 x 16	6x5/8	<b>161.502</b>	50
3,5 x 19	6x3/4	<b>161.503</b>	50
3,9 x 13	7x1/2	<b>161.504</b>	50
3,9 x 16	7x5/8	<b>161.505</b>	50
3,9 x 19	7x3/4	<b>161.506</b>	50
4,2 x 13	8x1/2	<b>161.507</b>	50
4,2 x 16	8x5/8	<b>161.508</b>	50
4,2 x 19	8x3/4	<b>161.509</b>	50
4,2 x 25	8x1"	<b>161.510</b>	50
4,8 x 16	10x5/8	<b>161.511</b>	50
4,8 x 22	10x7/8	<b>161.512</b>	50
4,8 x 32	10x1"1/4	<b>161.513</b>	50
5,5 x 38	12x1"1/2	<b>161.514</b>	50

Capuchón matrícula		Color	U.E.
	<b>162.559</b>	Blanco	100
	<b>162.560</b>	Negro	100
	<b>163.506</b>	Azul (RAL 5001)	100

Tornillos especiales placas matriculas	Ref.	Medidas	U.E.
	<b>161.441</b>	4,8 x 16	50
	<b>161.442</b>	4,2 x 19	50
	<b>161.443</b>	4,8 x 25	50
	<b>161.444</b>	5 x 15 (con tuerca)	50

Tornillos pilotos		Tamaño, color
	<b>164.694</b>	Corto, natural
	<b>164.695</b>	Largo, natural

Tornillos DIN 7504		Medidas	U.E.
	<b>162.607</b>	4,8 x 19	50
	<b>161.439</b>	4,8 x 25	50

Nota: se suministran en bolsas (U.E.) de 25 uds.

# TORNILLOS rosca chapa



# TORNILLOS para plástico



# TORNILLOS rosca métrica

Ø M5 x 11



**161.758**  
(U.E.=10)

Ø M6 x (10+21)



**161.458**  
(U.E.=10)

Ø M6 x 11  
arandela Ø 14



**161.753**  
(U.E.=25)

Ø M6 x 13



**161.733**  
(U.E.=10)

Ø M6 x 16  
arandela Ø 15



**161.475**  
(U.E.=10)

Ø M6 x 17



**162.528**  
(U.E.=25)

Ø M6 x 17,5



**161.732**  
(U.E.=10)

Ø M6 x 18



**161.734**  
(U.E.=10)

Ø M6 x 18



**162.529**  
(U.E.=25)

Ø M6 x 18



**161.752**  
(U.E.=25)

Ø M6 x 18  
arandela Ø 18



**161.730**  
(U.E.=25)

Ø M6 x 19



**161.486**  
(U.E.=10)

Ø M6 x 20



**161.722**  
(U.E.=25)

Ø M6 x 20



**161.456**  
(U.E.=25)

Ø M6 x 20



**161.457**  
(U.E.=25)

Ø M6 x 20



**161.706**  
(U.E.=50)

Ø M6 x 20  
arandela Ø 18



**161.727**  
(U.E.=25)

Ø M6 x 20  
arandela Ø 22



**161.724**  
(U.E.=25)

# TORNILLOS rosca métrica

Ø M6 x 21



**161.430**  
(U.E.=10)

Ø M6 x 22  
(cabeza 20 x 20)



**162.356**  
(U.E.=25)

Ø M6 x 22



**162.526**  
(U.E.=25)

Ø M6 x 25  
arandela Ø 18



**161.723**  
(U.E.=25)

Ø M6 x 25  
(En jaula móvil)



**161.450**  
(U.E.=10)

Ø M6 x 27



**162.397**  
(U.E.=10)

Ø M6 x 28  
arandela Ø 24



**161.731**  
(U.E.=25)

Ø M7 x 15



**161.728**  
(U.E.=10)

Ø M8 x 10,5  
arandela Ø 17



**161.754**  
(U.E.=25)

Ø M8 x 16



**162.363**  
(U.E.=25)

Ø M8 x 18  
(cabeza 20 x 20)



**162.357**  
(U.E.=25)

Ø M8 x 20



**161.476**  
(U.E.=10)

Ø M8 x 20



**161.705**  
(U.E.=10)

Ø M8 x 20



**161.455**  
(U.E.=10)

Ø M8 x 22



**162.619**  
(U.E.=10)

Ø M8 x 26,5



**161.729**  
(U.E.=10)

Ø M8 x 30



**161.440**  
(U.E.=10)

# UNIVERSALES

<b>Grapas Tapizados</b>		
	<b>161.472</b>	2,5 mm.
	<b>161.415</b>	2,7 mm.
	<b>162.600</b>	3 mm.
	<b>161.468</b>	4 mm.

Nota: se suministran en bolsas (U.E.) de 100 uds.

<b>Grapas NP-NR-SNP</b>		
	<b>161.469</b>	2,5 mm.
	<b>161.412</b>	3 mm.
	<b>161.413</b>	3,5 mm.
	<b>161.414</b>	4 mm.

Nota: se suministran en bolsas (U.E.) de 100 uds.

<b>Tuercas C-4800</b>		
	<b>162.625</b>	Ø M-4
	<b>162.626</b>	Ø M-5
	<b>162.627</b>	Ø M-6
	<b>162.628</b>	Ø M-7
	<b>162.629</b>	Ø M-8

Nota: se suministran en bolsas (U.E.) de 25 uds.

<b>Tuercas DIN 6923</b>		
	<b>162.588</b>	Ø M-5
	<b>162.589</b>	Ø M-6
	<b>162.590</b>	Ø M-8

Nota: se suministran en bolsas (U.E.) de 25 uds.

<b>Tuercas C-4830</b>		
	<b>162.413</b>	Ø M-4
	<b>162.925</b>	Ø M-5
	<b>162.414</b>	Ø M-6
	<b>162.585</b>	Ø M-7
	<b>162.415</b>	Ø M-8

Nota: se suministran en bolsas (U.E.) de 25 uds.



<b>... con arandela móvil</b>		
	<b>162.711</b>	Ø M-6
	<b>162.712</b>	Ø M-8

Nota: se suministran en bolsas (U.E.) de 25 uds.







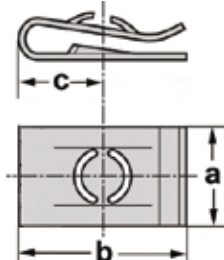

<b>Tuercas enjauladas</b>		
	<b>161.467</b>	Ø M-6

Nota: se suministran en bolsas (U.E.) de 10 uds.

# CLIPS METALICOS

 <p> <math>\varnothing</math> = diámetro tornillo                      a x b = medidas exteriores                      c = distancia eje fijación                 </p>		$\varnothing$	a x b (c)
	<b>161.701</b> (U.E.=50)	<b>M-4</b>	10 x 15 (8,5)
	<b>161.703</b> (U.E.=50)	<b>M-5</b>	10 x 15 (8,5)
	<b>162.444</b> (U.E.=50)	<b>M-5</b>	14 x 20 (12)
	<b>161.438</b> (U.E.=50)	<b>M-6</b>	15 x 22 (12,5)
	<b>162.442</b> (U.E.=50)	<b>M-6</b>	15x 22 (13)
	<b>161.497</b> (U.E.=50)	<b>M-6</b>	16x 24(14)
	<b>161.464</b> (U.E.=50)	<b>M-6</b>	16,3x 19(10)
	<b>161.499</b> (U.E.=50)	<b>M-8</b>	16,7x 25(15,5)

especial «oval»		$\varnothing$	a x b (c)
	<b>161.740</b> (U.E.=10)	<b>M-6 oval</b>	16 x 24 (13)

 <p> <math>\varnothing</math> = diámetro tornillo                      a x b = medidas exteriores                      c = distancia eje fijación                 </p>		$\varnothing$	a x b (c)
	<b>161.487</b> (U.E.=50)	<b>2,9</b>	8 x 10 (4,8)
	<b>161.447</b> (U.E.=50)	<b>2,9</b>	9 x 16,5 (10)
	<b>161.757</b> (U.E.=50)	<b>2,9</b>	10,8 x 13 (7)
	<b>162.591</b> (U.E.=50)	<b>3,5</b>	9 x 12 (7,5)
	<b>161.409</b> (U.E.=50)	<b>3,5</b>	11 x 16 (8,5)
	<b>161.489</b> (U.E.=50)	<b>3,5</b>	11,2 x 16,5 (8)
	<b>161.426</b> (U.E.=50)	<b>3,5</b>	12 x 15 (9)
	<b>161.490</b> (U.E.=50)	<b>3,9</b>	11,2 x 16 (8)













		$\varnothing$	a x b (c)
	<b>161.487</b> (U.E.=50)	<b>2,9</b>	8 x 10 (4,8)
	<b>161.447</b> (U.E.=50)	<b>2,9</b>	9 x 16,5 (10)
	<b>161.757</b> (U.E.=50)	<b>2,9</b>	10,8 x 13 (7)
	<b>162.591</b> (U.E.=50)	<b>3,5</b>	9 x 12 (7,5)
	<b>161.409</b> (U.E.=50)	<b>3,5</b>	11 x 16 (8,5)
	<b>161.489</b> (U.E.=50)	<b>3,5</b>	11,2 x 16,5 (8)
	<b>161.426</b> (U.E.=50)	<b>3,5</b>	12 x 15 (9)
	<b>161.490</b> (U.E.=50)	<b>3,9</b>	11,2 x 16 (8)

( Sigue .. / ..... )











# CLIPS METALICOS



 <p> <math>\varnothing</math> = diámetro tornillo            a x b = medidas exteriores            c = distancia eje fijación         </p>			
		$\varnothing$	a x b (c)
	<b>161.741</b> (U.E.=50)	4,2	11 x 13 (6,5)
	<b>161.418</b> (U.E.=50)	4,2	11 x 13 (7)
	<b>161.493</b> (U.E.=50)	4,2	11 x 15,5 (7,5)
	<b>161.736</b> (U.E.=50)	4,2	11 x 16,2 (8)
	<b>161.484</b> (U.E.=50)	4,2	11 x 16,2 (9)
	<b>162.635</b> (U.E.=50)	4,2	11 x 16,5 (8)
	<b>161.492</b> (U.E.=50)	4,2	11 x 16,5 (8,5)
	<b>161.410</b> (U.E.=50)	4,2	11 x 18 (9)
	<b>161.488</b> (U.E.=50)	4,2	11,6 x 15 (8)
	<b>161.744</b> (U.E.=50)	4,2	12 x 16,2 (8,5)
	<b>161.427</b> (U.E.=50)	4,2	15 x 20 (8,5)

		$\varnothing$	a x b (c)
	<b>161.495</b> (U.E.=50)	4,8	11 x 16,5 (8,5)
	<b>161.788</b> (U.E.=50)	4,8	11,1 x 16,5 (8)
	<b>161.738</b> (U.E.=50)	4,8	11,2 x 16,5 (9)
	<b>161.496</b> (U.E.=50)	4,8	12 x 15 (7)
	<b>161.411</b> (U.E.=50)	4,8	12 x 15 (8)
	<b>161.737</b> (U.E.=50)	4,8	12,5 x 16,5 (9,5)
	<b>161.787</b> (U.E.=25)	4,8	13,1 x 18,5 (10)
	<b>161.498</b> (U.E.=50)	4,8	15 x 16 (9)
	<b>161.491</b> (U.E.=50)	4,8	16,2 x 19 (11)
	<b>161.702</b> (U.E.=50)	4,8	16,3 x 19,3 (12)
	<b>161.749</b> (U.E.=50)	4,8	18,5 x 21,5 (12)
	<b>161.748</b> (U.E.=50)	4,8	22 x 25,5 (15)

( Sigue .. / ..... )

# CLIPS METALICOS

		Ø	a x b (c)
	<b>161.746</b> (U.E.=50)	5,5	14,5 x 25,8 (17,5)
	<b>161.771</b> (U.E.=50)	5,5	14,6 x 24,2 (20)
	<b>161.745</b> (U.E.=25)	5,5	15,8 x 23,6 (13)
	<b>161.704</b> (U.E.=50)	5,6	13,2 x 21 (12)
	<b>161.437</b> (U.E.=50)	6,3	14 x 30 (18,5)
	<b>161.449</b> (U.E.=50)	6,3	15 x 23 (14)
	<b>161.436</b> (U.E.=50)	6,3	16 x 31,2 (22,5)
	<b>162.479</b> (U.E.=50)	6,3	16 x 20,2 (11)
	<b>161.747</b> (U.E.=50)	6,3	16,2 x 24,8 (14)
	<b>161.756</b> (U.E.=25)	6,3	16,5 x 26,5 (14)

		Ø	a x b (c)
	<b>161.465</b> (U.E.=50)	6,3	17,2 x 23 (14)
	<b>162.634</b> (U.E.=50)	6,3	18,2 x 16,5 (9)

\* U.E.: Unidad de Envase

# UNIVERSAL



161.483

Ø cabeza : 15 mm.  
Ø agujero : 7 mm.

U.E.	DESCRIPCION	Ref. Adaptable
50	Fijac. metálica universal pasoruedas y varios	161.483

## REMACHES METALICOS

### REMACHES UNIVERSALES



Medidas	Aluminio	Negro	U.E.
Ø 3,2 x 6	161.600	161.650	100
Ø 3,2 x 10	161.601	161.651	100
Ø 4 x 8	161.602		100
Ø 4 x 10	161.603	161.652	100
Ø 4 x 12	161.604		100
Ø 4 x 14	161.605	161.653	100
Ø 4,8 x 10	161.606	161.654	100
Ø 4,8 x 12	161.607	161.655	100
Ø 4,8 x 14	161.608	161.656	100



Remache Ø 2,4 x 5 especial Fiat, Opel, PSA, VAG (U.E.=50)

162.362



Remache **estanco** Ø 4 x 11, especial Ford Fiesta (U.E.=50)

162.384



Remache Ø 4,8 x 12 **con cabeza Ø 10**, especial Renault (U.E.=50)

162.939

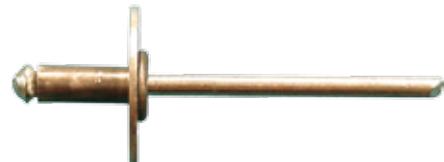

Remache Ø5 x 11, **con arandela Ø 20**, especial Renault (U.E.=25)

162.709

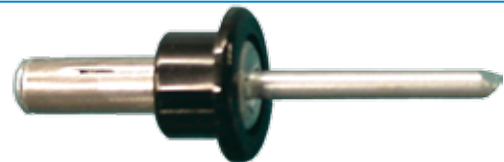

Remache Ø 7,5 x 28 especial PSA (U.E.=10)

161.481

# TACOS PLASTICOS

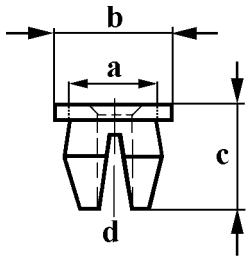

$\varnothing a$  = diámetro taladro  
 $\varnothing b$  = diámetro cabeza  
 $c$  = altura fijación  
 $\varnothing d$  = diámetro agujero para tornillo

		$\varnothing a$	$\varnothing b$	$c$	$\varnothing d$
	<b>163.219</b> (U.E.=25)	8	11	16	3,9
	<b>162.242</b> (U.E.=25)	8	11	17	3,5
	<b>162.243</b> (U.E.=25)	10	14	19	4,8
	<b>162.457</b> (U.E.=25)	11	15	19	5

		$\varnothing a$	$\varnothing b$	$c$	$\varnothing d$
	<b>163.063</b> (U.E.=25)	6x15	11x21	17	3,5
	<b>162.851</b> (U.E.=25)	6,7x12,9	9,6x16,1	11,9	2,9
	<b>163.767</b> (U.E.=50)	7x11,7	9x14,5	12	4,2
	<b>162.902</b> (U.E.=25)	7x12	9x15	10	4,2
	<b>162.523</b> (U.E.=50)	7x13	10x16	10	4,2
	<b>163.502</b> (U.E.=25)	7x14	9x15	10	3,9
	<b>163.350</b> (U.E.=50)	7x14	9x15	10	4,2
	<b>163.881</b> (U.E.=50)	7x14	9,5x15	10	2,9
	<b>162.892</b> (U.E.=50)	7x14	11x18	12	3,9
	<b>163.222</b> (U.E.=25)	7x14	13x20	17,2	3,9
	<b>162.483</b> (U.E.=25)	7x14	13x20	17	4,2
	<b>162.933</b> (U.E.=25)	7,2x14	13x20	17	4,2
	<b>162.888</b> (U.E.=50)	7x15	10x18	10	4,2
	<b>163.882</b> (U.E.=10)	7x15	14x20	17	3,9
	<b>163.298</b> (U.E.=25)	7,5x11,4	9,5x16,6	11	2,9

# TACOS PLASTICOS

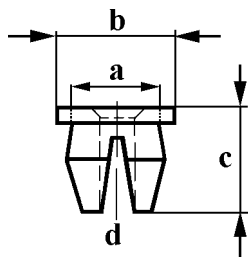





- Ø a = diámetro taladro
- Ø b = diámetro cabeza
- c = altura fijación
- Ø d = diámetro agujero para tornillo

		Ø a	Ø b	c	Ø d
	<b>162.326</b> (U.E.=100)	6	9,5	7,5	2,5
	<b>162.842</b> (U.E.=100)	6x6,5	10	7	2,5
	<b>162.963</b> (U.E.=50)	6,7	9	9,5	3,9
	<b>162.245</b> (U.E.=25)	6x7	15	9	3,5
	<b>162.240</b> (U.E.=100)	7	9	10	3,5
	<b>163.181</b> (U.E.=50)	7	9	12	3,5
	<b>162.715</b> (U.E.=50)	7	9	12	4,2
	<b>162.238</b> (U.E.=100)	7	9,5	9	3
	<b>162.237</b> (U.E.=100)	7	9,5	9	3,5
	<b>163.172</b> (U.E.=25)	7	10	8,5	4,2
	<b>162.609</b> (U.E.=50)	7	10	10	3
	<b>162.817</b> (U.E.=25)	7	10	13	3,5
	<b>162.717</b> (U.E.=25)	7	10	16	3,5
	<b>162.401</b> (U.E.=50)	7	11	13	3

		Ø a	Ø b	c	Ø d
	<b>162.776</b> (U.E.=25)	7	11	14	3,5
	<b>162.331</b> (U.E.=50)	7	11	14	4
	<b>162.775</b> (U.E.=25)	7	12	17	4
	<b>162.244</b> (U.E.=100)	7	13	9	4,2
	<b>163.281</b> (U.E.=25)	7	13	16	3,9
	<b>163.611</b> (U.E.=25)	7	14	21	4,2
	<b>163.498</b> (U.E.=50)	7	16	10	4,8
	<b>163.426</b> (U.E.=50)	7,2	9	9	3,5
	<b>162.774</b> (U.E.=50)	7x7,5	7x12	12	3,5
	<b>162.534</b> (U.E.=50)	8	11	13	4,5
	<b>163.275</b> (U.E.=50)	8	12	9	5,5
	<b>163.427</b> (U.E.=50)	8	13	12	4,2
	<b>163.211</b> (U.E.=50)	8	14	10	5,5
	<b>163.883</b> (U.E.=10)	8	14	16,5	

# TACOS PLASTICOS

		Ø a	Ø b	c	Ø d
	<b>162.903</b> (U.E.=25)	8	15,5	17	4
	<b>163.051</b> (U.E.=25)	8	16	19	4,8
	<b>162.368</b> (U.E.=25)	8	18	14	5
	<b>162.955</b> (U.E.=25)	8x10	20	12,5	5,5
	<b>163.439</b> (U.E.=50)	8,2	11	12	4,2
	<b>162.985</b> (U.E.=50)	8,2	12	11,9	4,2
	<b>162.649</b> (U.E.=100)	8,5	11,5	11	4
	<b>163.484</b> (U.E.=50)	8,5	15	10	5,5
	<b>163.519</b> (U.E.=25)	8,5	17	10	5,5
	<b>163.689</b> (U.E.=25)	8,5	18	19,5	4,2
	<b>163.192</b> (U.E.=25)	8,5x10,5	13,4x15,3	10,2	5,5
	<b>163.256</b> (U.E.=25)	9	17	11	5,5
	<b>163.622</b> (U.E.=25)	9	20,5	11,5	5,5





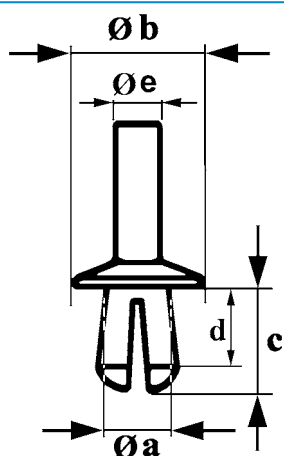

		Ø a	Ø b	c	Ø d
	<b>163.367</b> (U.E.=25)	9,5	13	21	6,35
	<b>163.505</b> (U.E.=25)	9,5	13,5	19,5	4,8
	<b>162.480</b> (U.E.=50)	9,5	22	21	4,8
	<b>163.180</b> (U.E.=10)	9,5x14	20	14	4,8
	<b>163.538</b> (U.E.=50)	10	12	11,5	4,8
	<b>162.241</b> (U.E.=50)	10	13	13	3,5
	<b>162.928</b> (U.E.=25)	10	13	20	4,8
	<b>162.718</b> (U.E.=25)	10	13	20	5,5
	<b>162.545</b> (U.E.=50)	10	14	15	4
	<b>163.274</b> (U.E.=50)	10	16	10	5,5
	<b>162.811</b> (U.E.=50)	10x13	13x14	19	5,5
	<b>163.377</b> (U.E.=50)	10,8x11,2	16	12	6,35









\* U.E.: Unidad de Envase

# REMACHES PLASTICOS











$\varnothing a$  = diámetro agujero  
 $\varnothing b$  = diámetro cabeza  
 $c$  = altura total fijación  
 $d$  = altura fijación  
 $\varnothing e$  = diámetro espiga







		$\varnothing a$	$\varnothing b$	$c$ ( $d$ )	$\varnothing e$
	<b>162.431</b> (U.E.=100)	3,5	8	7 (6)	2,1
	<b>163.717</b> (U.E.=100)	4	7,8	8,5 (7)	2
	<b>162.664</b> (U.E.=25)	4,5	7	7 (5,1)	4,2
	<b>163.926</b> (U.E.=50)	5	9	7 (5,5)	3
	<b>163.910</b> (U.E.=50)	5	10	7,5 (5,5)	3
	<b>163.329</b> (U.E.=50)	5	10	11 (9)	3,2
	<b>162.259</b> (U.E.=100)	5	10	15,8 (12)	2,9

		$\varnothing a$	$\varnothing b$	$c$ ( $d$ )	$\varnothing e$
	<b>162.647</b> (U.E.=100)	5	11,3	6,7 (5,3)	3,2
	<b>163.792</b> (U.E.=50)	5	12	11 (8,2)	3
	<b>162.456</b> (U.E.=50)	5,5	9,4	10,8 (8,2)	3,2
	<b>163.793</b> (U.E.=50)	5,5	12	11 (9,5)	3
	<b>163.299</b> (U.E.=50)	5,5	16	10 (8)	3,5
	<b>163.303</b> (U.E.=50)	5,5	16	10 (8)	3,5
	<b>163.305</b> (U.E.=50)	5,5	16	11 (7,5)	3
	<b>163.056</b> (U.E.=50)	5,5	10x12	10 (6,4)	4x5

( Sigue .. / ..... )

# REMACHES PLASTICOS

		Ø a	Ø b	C (d)	Ø e
	<b>162.819</b> (U.E.=100)	6	10	11,5 (9,1)	3,2
	<b>162.821</b> (U.E.=100)	6	10	12 (9)	4
	<b>162.519</b> (U.E.=25)	6	10	18 (9)	4,7
	<b>163.961</b> (U.E.=50)	6	11	10 (8,3)	3,9
	<b>163.485</b> (U.E.=50)	6	12	9 (8)	3,5
	<b>163.140</b> (U.E.=50)	6	12	13 (8)	3,9
	<b>163.487</b> (U.E.=50)	6	12	14 (13)	3,5
	<b>162.624</b> (U.E.=100)	6	13	9,2 (7,8)	3,9
	<b>163.271</b> (U.E.=10)	6	15	11 (9)	4

		Ø a	Ø b	C (d)	Ø e
	<b>163.295</b> (U.E.=25)	6	15	12,5 (7,5)	3,8
	<b>163.270</b> (U.E.=10)	6	15	13,5 (9)	4
	<b>163.044</b> (U.E.=50)	6	15	15 (12)	3,6
	<b>163.047</b> (U.E.=50)	6	15	20 (17)	3,5
	<b>163.810</b> (U.E.=25)	6	15	22,5 (13)	3,9
	<b>163.054</b> (U.E.=50)	6	16	10 (7)	3,9
	<b>163.198</b> (U.E.=25)	6	16	14 (12)	3,4





( Sigue ... / ..... )

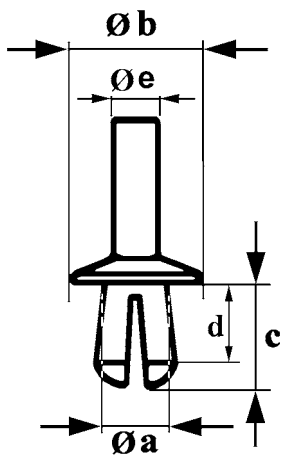









# REMACHES PLASTICOS













$\varnothing a$  = diámetro agujero  
 $\varnothing b$  = diámetro cabeza  
 $c$  = altura total fijación  
 $d$  = altura fijación  
 $\varnothing e$  = diámetro espiga









		$\varnothing a$	$\varnothing b$	$c$ (d)	$\varnothing e$
	<b>163.235</b> (U.E.=25)	6	16	10 (15)	3,9
	<b>163.068</b> (U.E.=25)	6	20	14 (10)	3,5
	<b>163.046</b> (U.E.=50)	6	20	14 (12)	3,6
	<b>163.045</b> (U.E.=50)	6	20	15 (12)	3,6
	<b>163.048</b> (U.E.=50)	6	20,5	20 (17)	3,4

		$\varnothing a$	$\varnothing b$	$c$ (d)	$\varnothing e$
	<b>163.261</b> (U.E.=50)	6x6	7x15	13 (7,4)	4
	<b>162.852</b> (U.E.=50)	6x6	8x15	12 (8,6)	4
	<b>163.210</b> (U.E.=50)	6x8	16	(9)	4
	<b>163.486</b> (U.E.=50)	6,2	10	9 (8)	3,6
	<b>162.389</b> (U.E.=100)	6,2	11	10 (8)	4
	<b>162.481</b> (U.E.=50)	6,2	12	9 (7)	3,3
	<b>162.424</b> (U.E.=50)	6,2	12,2	11 (7,4)	4
	<b>163.168</b> (U.E.=10)	6,2	14	11,5 (9)	4
	<b>162.957</b> (U.E.=25)	6,2	16	17 (10)	4

( Sigue ... / ..... )

# REMACHES PLASTICOS

		Ø a	Ø b	C (d)	Ø e
	<b>163.328</b> (U.E.=25)	6,2	17	9	4
	<b>163.442</b> (U.E.=50)	6,2	17	17 (11)	3,5
	<b>163.169</b> (U.E.=10)	6,2	18	11 (7)	4
	<b>162.906</b> (U.E.=50)	6,2	20	10 (7,4)	4
	<b>163.206</b> (U.E.=50)	6,5	10x22	7,2 (3,5)	4
	<b>162.666</b> (U.E.=25)	6,5	10x22	9 (3,7)	4
	<b>163.392</b> (U.E.=25)	6,5	15	8 (8)	3,5
	<b>162.258</b> (U.E.=50)	6,5	15	11 (9)	4
	<b>163.475</b> (U.E.=10)	6,5	15	13 (8)	4,3
	<b>163.300</b> (U.E.=10)	6,5	15	13	5

		Ø a	Ø b	C (d)	Ø e
	<b>163.859</b> (U.E.=10)	6,5	15	17	4,5
	<b>163.640</b> (U.E.=25)	6,5	16	11 (8)	3,8
	<b>163.389</b> (U.E.=25)	6,5	16	11 (9)	4
	<b>163.301</b> (U.E.=10)	6,5	16	13	10
	<b>163.070</b> (U.E.=25)	6,5	19	8,6 (5,6)	3,3
	<b>163.757</b> (U.E.=25)	6,5	20	11,2 (8,5)	3,9
	<b>163.610</b> (U.E.=25)	6,5	20	20 (18)	3,4
	<b>162.979</b> (U.E.=50)	6,5	22	14 (10)	3,5





\* U.E.: Unidad de Envase

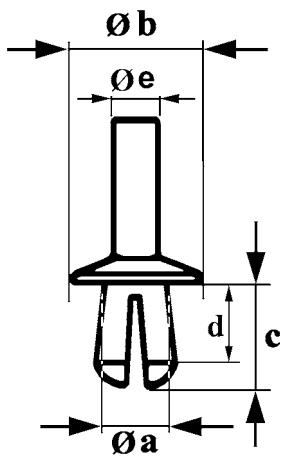







( Sigue .. / ..... )

# REMATCHES PLASTICOS









$\varnothing a$  = diámetro agujero  
 $\varnothing b$  = diámetro cabeza  
 $c$  = altura total fijación  
 $d$  = altura fijación  
 $\varnothing e$  = diámetro espiga







		$\varnothing a$	$\varnothing b$	$c$ (d)	$\varnothing e$
	<b>163.735</b> (U.E.=25)	6,5	17,5	9,5 (6)	4
	<b>163.249</b> (U.E.=10)	6,8	17	6 (5,3)	4,4
	<b>163.269</b> (U.E.=10)	7	17	10 (8)	5
	<b>163.530</b> (U.E.=10)	7	18	8 (8)	5
	<b>162.505</b> (U.E.=50)	7	18	17 (13)	4
	<b>163.128</b> (U.E.=25)	7	19,5	16 (7)	4
	<b>163.302</b> (U.E.=10)	7	20	8 (6)	10

		$\varnothing a$	$\varnothing b$	$c$ (d)	$\varnothing e$
	<b>163.476</b> (U.E.=10)	7	20	10 (9)	5
	<b>163.529</b> (U.E.=10)	7	20	11 (9)	5
	<b>163.167</b> (U.E.=10)	7	20	11	6
	<b>163.827</b> (U.E.=50)	7	20	11,5 (8,5)	4
	<b>163.125</b> (U.E.=25)	7	11x18	13 (5)	3x3
	<b>162.812</b> (U.E.=50)	7x7	11	10 (5)	4
	<b>163.020</b> (U.E.=25)	7x8	10x12	7,7 (5)	3,6
	<b>163.369</b> (U.E.=50)	7,2	20	14 (12)	4,7

( Sigue .. / ..... )

# REMACHES PLASTICOS

		Ø a	Ø b	C (d)	Ø e
	<b>163.794</b> (U.E.=50)	7,5	17	14,5 (8)	4
	<b>163.813</b> (U.E.=10)	7,5	18	18,5 (13,5)	5,5
	<b>163.743</b> (U.E.=25)	7,5	21,7	13 (10,5)	5,5
	<b>162.632</b> (U.E.=50)	8	12	11 (7)	5
	<b>162.665</b> (U.E.=25)	8	12x17	9,6 (6)	5
	<b>162.927</b> (U.E.=50)	8	13	15 (12)	4
	<b>162.843</b> (U.E.=25)	8	14	11 (7)	4





		Ø a	Ø b	C (d)	Ø e
	<b>163.036</b> (U.E.=10)	8	14	12 (7)	4x4
	<b>163.922</b> (U.E.=50)	8	15,3	13 (8)	5,5
	<b>163.923</b> (U.E.=50)	8	15,3	13 (8)	5,5
	<b>163.307</b> (U.E.=100)	8	16	11 (6)	5
	<b>162.373</b> (U.E.=100)	8	16	12,5 (8)	4,9
	<b>163.304</b> (U.E.=25)	8	16	14 (10)	4,7
	<b>163.503</b> (U.E.=10)	8	18	12 (10)	6

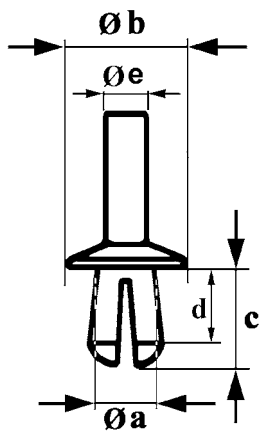







( Sigue .. / ..... )

# REMATCHES PLASTICOS



$\varnothing a$  = diámetro agujero  
 $\varnothing b$  = diámetro cabeza  
 c = altura total fijación  
 d = altura fijación  
 $\varnothing e$  = diámetro espiga







		$\varnothing a$	$\varnothing b$	c (d)	$\varnothing e$
	<b>163.166</b> (U.E.=10)	8	18	14 (7,6)	6x7
	<b>162.517</b> (U.E.=50)	8	18	18 (14)	4,8
	<b>163.889</b> (U.E.=50)	8	19	15,2 (12)	5
	<b>163.918</b> (U.E.=25)	8	19	17 (9,5)	7x4
	<b>163.014</b> (U.E.=50)	8	20	8,5 (5,4)	4

		$\varnothing a$	$\varnothing b$	c (d)	$\varnothing e$
	<b>163.074</b> (U.E.=25)	8	20	9 (6)	5
	<b>163.035</b> (U.E.=50)	8	20	9 (6)	6
	<b>163.171</b> (U.E.=10)	8	20	10 (6,4)	5,3
	<b>163.277</b> (U.E.=10)	8	20	12,5 (7)	5x5
	<b>163.344</b> (U.E.=50)	8	20	13 (8)	3x6
	<b>163.482</b> (U.E.=10)	8	20	13 (8)	6x7
	<b>163.169</b> (U.E.=10)	8	20	13,5 (8)	3,9
	<b>163.069</b> (U.E.=25)	8	20	13,5 (11)	4,9

( Sigue .. / ..... )

# REMACHES PLASTICOS





		Ø a	Ø b	C (d)	Ø e
	<b>163.409</b> (U.E.=50)	8	20	14 (13)	5
	<b>163.815</b> (U.E.=10)	8	20	15 (11)	5x5
	<b>163.384</b> (U.E.=10)	8	20	15 (7)	6
	<b>163.448</b> (U.E.=25)	8	20	16 (11)	7
	<b>163.278</b> (U.E.=10)	8	20	20 (11)	5,8
	<b>163.091</b> (U.E.=50)	8	20	21 (12)	5x7
	<b>163.306</b> (U.E.=50)	8	22	13 (10)	4,4



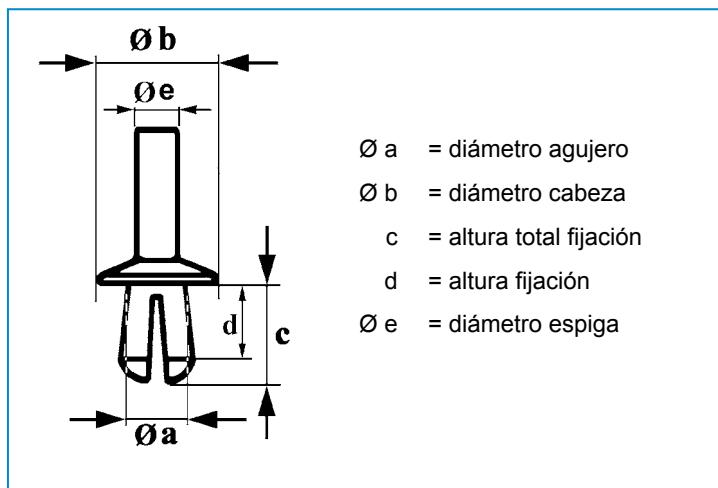



		Ø a	Ø b	C (d)	Ø e
	<b>162.260</b> (U.E.=50)	8	24	16 (11)	5
	<b>163.734</b> (U.E.=25)	8	25	24,5 (14)	6,2x4
	<b>163.780</b> (U.E.=25)	8	30	16 (8,5)	5
	<b>162.765</b> (U.E.=50)	8x8	16	14 (10)	5,5
	<b>162.958</b> (U.E.=25)	8x10	12	15 (4,5)	5
	<b>162.766</b> (U.E.=50)	8x10	24	13 (10)	5

( Sigue .. / ..... )

# REMACHES PLASTICOS













		$\varnothing a$	$\varnothing b$	$c$ (d)	$\varnothing e$
	<b>163.088</b> (U.E.=50)	8,2	18	14 (10)	4
	<b>163.925</b> (U.E.=50)	8,5	12	10 (7)	4,9
	<b>163.981</b> (U.E.=10)	8,5	15	27 (13)	5,2
	<b>162.341</b> (U.E.=100)	8,5	16	13 (8)	4
	<b>163.474</b> (U.E.=10)	8,5	18	11 (8)	6

		$\varnothing a$	$\varnothing b$	$c$ (d)	$\varnothing e$
	<b>163.390</b> (U.E.=50)	8,5	18	12 (8)	5,8
	<b>163.391</b> (U.E.=50)	8,5	18	12 (8)	5,8
	<b>163.963</b> (U.E.=25)	8,5	18	19 (14,8)	4,8
	<b>163.127</b> (U.E.=50)	8,5	20	11 (4,4)	4x4
	<b>163.924</b> (U.E.=25)	8,5	25	13,5 (10,5)	6
	<b>163.296</b> (U.E.=10)	9	15	26 (16)	5,3
	<b>163.756</b> (U.E.=25)	9	16	12	6,7

( Sigue ... / ..... )

# REMACHES PLASTICOS

		Ø a	Ø b	C (d)	Ø e
	<b>163.358</b> (U.E.=10)	9	18	27 (19)	7x8
	<b>163.297</b> (U.E.=10)	9	20	27 (17)	5,5
	<b>163.276</b> (U.E.=10)	10	18	18 (13)	8x10
	<b>163.037</b> (U.E.=50)	10	20	14 (11)	7
	<b>163.164</b> (U.E.=10)	10	20	15 (11)	8x9
	<b>163.802</b> (U.E.=10)	10	20	20 (15,5)	8x8

		Ø a	Ø b	C (d)	Ø e
	<b>163.163</b> (U.E.=10)	10	20	25 (15)	7
	<b>162.425</b> (U.E.=25)	11	25	14 (8)	7
	<b>163.903</b> (U.E.=50)	12	18	10 (6)	8
	<b>163.973</b> (U.E.=10)	14	25	21 (13)	8
	<b>163.814</b> (U.E.=25)	15	22	16 (12)	12



# BOTONES FIJACION

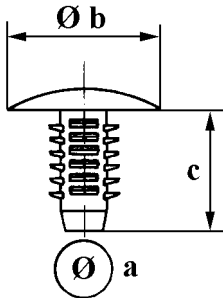

$\varnothing a$  = diámetro taladro  
 $\varnothing b$  = diámetro cabeza  
 $c$  = altura fijación

$\varnothing a = 5,2$   
 $\varnothing b = 16$   
 $c = 26$



**163.317 negro**  
(U.E.=50)

$\varnothing a = 5$   
 $\varnothing b = 11$   
 $c = 12$



**163.086 negro**  
(U.E.=50)

$\varnothing a = 6$   
 $\varnothing b = 14$   
 $c = 13$



**163.678 negro**  
(U.E.=50)

$\varnothing a = 6$   
 $\varnothing b = 12$   
 $c = 18$



**162.883 blanco**  
(U.E.=100)

$\varnothing a = 6$   
 $\varnothing b = 13$   
 $c = 18$



**163.173 negro**  
(U.E.=25)

$\varnothing a = 6$   
 $\varnothing b = 15$   
 $c = 17$



**163.217 gris**  
(U.E.=25)

$\varnothing a = 6$   
 $\varnothing b = 22$   
 $c = 21$



**163.099 negro**  
(U.E.=25)

$\varnothing a = 6,2$   
 $\varnothing b = 30$   
 $c = 14$



**163.385 negro**  
(U.E.=25)

$\varnothing a = 6,5$   
 $\varnothing b = 12$   
 $c = 14$



**162.823 negro**  
(U.E.=100)

$\varnothing a = 6,5$   
 $\varnothing b = 12$   
 $c = 18$



**162.447 negro**  
(U.E.=100)

$\varnothing a = 6,5$   
 $\varnothing b = 13$   
 $c = 15$



**162.705 negro**  
(U.E.=25)

$\varnothing a = 6,5$   
 $\varnothing b = 18$   
 $c = 15$



**162.643 negro**  
(U.E.=100)

$\varnothing a = 6,5$   
 $\varnothing b = 18$   
 $c = 17$



**162.806 negro**  
(U.E.=100)

$\varnothing a = 6,5$   
 $\varnothing b = 18$   
 $c = 17$



**163.386 negro**  
(U.E.=100)

$\varnothing a = 6,5$   
 $\varnothing b = 19$   
 $c = 15$



**162.815 negro**  
(U.E.=50)

$\varnothing a = 6,5$   
 $\varnothing b = 20$   
 $c = 12$



**163.308 negro**  
(U.E.=100)

$\varnothing a = 6,5$   
 $\varnothing b = 20$   
 $c = 13,5$



**162.450 negro**  
(U.E.=50)

$\varnothing a = 6,5$   
 $\varnothing b = 20$   
 $c = 16$



**162.975 negro**  
(U.E.=25)

$\varnothing a = 6,5$   
 $\varnothing b = 21$   
 $c = 19$



**163.879 negro**  
(U.E.=50)

$\varnothing a = 6,5$   
 $\varnothing b = 24,5$   
 $c = 11$



**163.327 negro**  
(U.E.=25)

$\varnothing a = 6,5$   
 $\varnothing b = 30$   
 $c = 16$



**163.129 negro**  
(U.E.=50)

# BOTONES FIJACION

Ø a = 6,7  
Ø b = 20  
c = 14



**163.006**  
negro  
(U.E.=50)

Ø a = 6,7  
Ø b = 20  
c = 14



**163.490**  
gris  
(U.E.=50)

Ø a = 6,7  
Ø b = 30  
c = 17



**163.007**  
negro  
(U.E.=50)

Ø a = 6,7  
Ø b = 30  
c = 17



**163.489**  
gris  
(U.E.=50)

Ø a = 7  
Ø b = 12,5  
c = 17,5



**162.454**  
negro  
(U.E.=100)

Ø a = 7  
Ø b = 14  
c = 16



**162.221**  
negro  
(U.E.=100)

Ø a = 7  
Ø b = 14  
c = 16



**162.222**  
gris  
(U.E.=100)

Ø a = 7  
Ø b = 14  
c = 16



**162.320**  
blanco  
(U.E.=100)

Ø a = 7  
Ø b = 15  
c = 13



**162.493**  
negro  
(U.E.=100)

Ø a = 7  
Ø b = 16  
c = 20



**163.630**  
negro  
(U.E.=50)

Ø a = 7  
Ø b = 17  
c = 15,5



**163.890**  
negro  
(U.E.=50)

Ø a = 7  
Ø b = 19  
c = 11



**162.453**  
negro  
(U.E.=100)

Ø a = 7  
Ø b = 19  
c = 27



**163.878**  
negro  
(U.E.=10)

Ø a = 7  
Ø b = 20  
c = 13



**162.908**  
negro  
(U.E.=50)

Ø a = 7  
Ø b = 20  
c = 16



**162.660**  
negro  
(U.E.=100)

Ø a = 7  
Ø b = 20  
c = 17



**163.837**  
negro  
(U.E.=50)

Ø a = 7  
Ø b = 20  
c = 18



**162.935**  
negro  
(U.E.=100)

Ø a = 7  
Ø b = 20  
c = 20



**162.878**  
negro  
(U.E.=25)

Ø a = 7  
Ø b = 20  
c = 25



**163.742**  
negro  
(U.E.=25)

Ø a = 7  
Ø b = 22  
c = 25



**162.657**  
negro  
(U.E.=50)

Ø a = 7  
Ø b = 26  
c = 24



**163.087**  
negro  
(U.E.=25)

Ø a = 7  
Ø b = 28  
c = 16



**163.079**  
negro  
(U.E.=25)

Ø a = 7,2  
Ø b = 18  
c = 14



**163.174**  
negro  
(U.E.=25)

( Sigue .. / ..... )

# BOTONES FIJACION

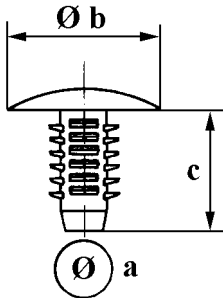

$\varnothing a$  = diámetro taladro  
 $\varnothing b$  = diámetro cabeza  
 $c$  = altura fijación

$\varnothing a = 7,5$   
 $\varnothing b = 15$   
 $c = 17,5$



**162.200**  
**gris**  
 (U.E.=100)

$\varnothing a = 7,5$   
 $\varnothing b = 15$   
 $c = 17,5$



**162.201**  
**marrón**  
 (U.E.=50)

$\varnothing a = 7,5$   
 $\varnothing b = 15$   
 $c = 17,5$



**162.202**  
**negro**  
 (U.E.=100)

$\varnothing a = 7,5$   
 $\varnothing b = 15$   
 $c = 22,5$



**162.603**  
**negro**  
 (U.E.=50)

$\varnothing a = 7,5$   
 $\varnothing b = 19$   
 $c = 21$



**163.201**  
**negro**  
 (U.E.=50)

$\varnothing a = 7,5$   
 $\varnothing b = 19,8$   
 $c = 15$



● **163.945**  
**negro**  
 (U.E.=50)

$\varnothing a = 7,5$   
 $\varnothing b = 20$   
 $c = 12$



**162.706**  
**negro**  
 (U.E.=50)

$\varnothing a = 7,5$   
 $\varnothing b = 20,3$   
 $c = 18$

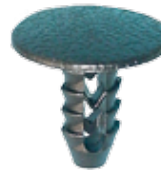

**162.614**  
**negro**  
 (U.E.=100)

$\varnothing a = 7,5$   
 $\varnothing b = 20$   
 $c = 23,5$



**162.211**  
**negro**  
 (U.E.=100)

$\varnothing a = 7,5$   
 $\varnothing b = 20$   
 $c = 23,5$



**162.212**  
**gris**  
 (U.E.=50)

$\varnothing a = 7,5$   
 $\varnothing b = 24$   
 $c = 31$



**162.646**  
**negro**  
 (U.E.=100)

$\varnothing a = 7,5$   
 $\varnothing b = -$   
 $c = 27$



● **163.969**  
**negro**  
 (U.E.=25)

$\varnothing a = 7,5$   
 $\varnothing b = 21,5$   
 $c = 15$



● **163.886**  
**negro**  
 (U.E.=50)

$\varnothing a = 8$   
 $\varnothing b = 10$   
 $c = 15$



**162.440**  
**blanco**  
 (U.E.=50)

$\varnothing a = 8$   
 $\varnothing b = 16$   
 $c = 17$



**162.321**  
**blanco**  
 (U.E.=50)

$\varnothing a = 8$   
 $\varnothing b = 16$   
 $c = 17$



**162.602**  
**negro**  
 (U.E.=100)

$\varnothing a = 8$   
 $\varnothing b = 16$   
 $c = 17$



**163.009**  
**negro**  
 (U.E.=25)

$\varnothing a = 8$   
 $\varnothing b = 16$   
 $c = 19$



**162.934**  
**negro**  
 (U.E.=100)

$\varnothing a = 8$   
 $\varnothing b = 18$   
 $c = 16,5$



**162.382**  
**gris oscuro**  
 (U.E.=50)

$\varnothing a = 8$   
 $\varnothing b = 18$   
 $c = 16,5$



**162.383**  
**negro**  
 (U.E.=50)

$\varnothing a = 8$   
 $\varnothing b = 18$   
 $c = 16,5$



**162.910**  
**gris claro**  
 (U.E.=50)

$\varnothing a = 8$   
 $\varnothing b = 18$   
 $c = 25$



**162.579**  
**gris oscuro**  
 (U.E.=100)

$\varnothing a = 8$   
 $\varnothing b = 18$   
 $c = 25$



**162.580**  
**negro**  
 (U.E.=100)

$\varnothing a = 8$   
 $\varnothing b = 18$   
 $c = 26$



**162.753**  
**gris oscuro**  
 (U.E.=50)

( Sigue ... / ..... )

# BOTONES FIJACION



# VARIOS

## TAPONES UNIVERSALES



162.661



162.662



162.663

U.E. Medidas

25	<b>162.661</b>	Cabeza 16,7 mm. Agujero mín/máx. 9,5/13,5 mm.
25	<b>162.662</b>	Cabeza 24,8 mm. Agujero mín/máx. 14/21 mm.
25	<b>162.663</b>	Cabeza 34,8 mm. Agujero mín/máx. 22/30 mm.

Omegas

Ø interior

U.E.



162.332

Ø 8

25



162.570

Ø 11

25



162.344

Ø 13

25



162.575

Ø 16

25



162.940

Ø 24

25



188.007

Tirante goma capó con soporte de plancha  
PEQUEÑO

188.054

Tirante goma capó con soporte de plancha  
GRANDE

U.E. = 2

# ABRAZADERAS

ABRAZADERAS PLASTICAS	TRICLO	ANCHO	LARGO
 <p>U.E. = 100</p>	301.450	2,5	98
	301.452	2,9	200
	301.453	3,6	140
	301.454	3,6	290
	301.455	4,8	178
	301.456	4,8	250
	301.457	4,8	290
	301.447	4,8	360
	301.458	7,8	240
	301.459	7,8	300
	301.460	7,8	365
	301.448	7,8	450
	301.449	7,8	540

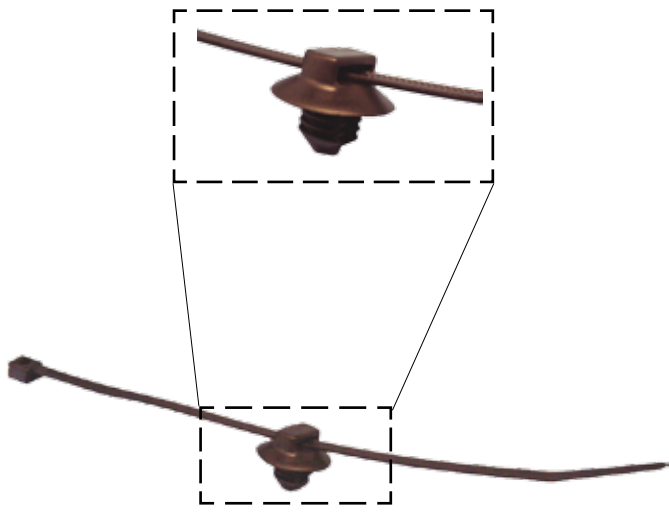
	301.021	Abrazadera 3,6 x 140 con soporte
	301.022	Abrazadera 3,6 x 200 con soporte
		U.E. = 50

# Reguladores Faros Manuales



**162.252**

Fiat Uno

Ref.Adap. 5952101



**162.253**

Fiat Uno

Ref.Adap. 5946583



**162.298 - Derecha**  
**162.299 - Izquierda**

Ford Fiesta '89->'96

Ref.Ad. 6186660 (derecha) / 6186659 (izquierda)



**162.756**

PSA ZX, P-106, P-306,

Ref.Adap. 96090463



**162.757**

PSA Jumpy I y II, ZX, P-106, P-306, Expert I y II

Ref.Adap. 6224.79 / 96082019

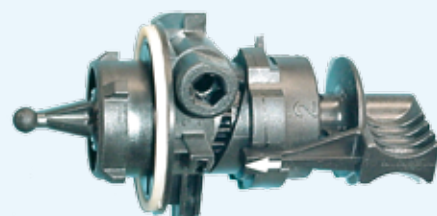

**162.758**

PSA Berlingo, Evasion, Saxo, Partner

Ref.Adap. 6224.69



**162.650**

Citroën AX

Ref.Adap. 95634217



**162.754**

Citroën C-15

Ref.Adap. 75510922

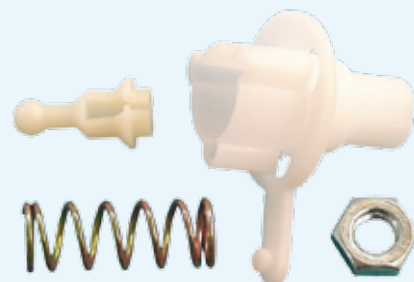

**162.755**

Citroën C-15

Ref.Adap. 95598693

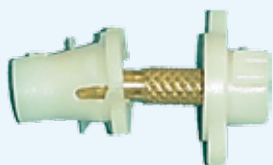

**162.292**

Volkswagen Golf '90

Ref.Adap. 191 941 133

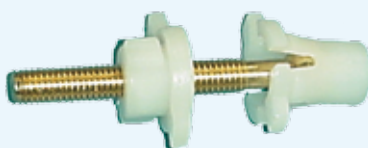

**162.293**

Volkswagen Golf '90

Ref.Adap. 191 941 141



**163.769**

BMW Serie 5 (E39) '95->'02

Ref.Adap. 63 12 0 027 924

# Reguladores Faros Eléctricos

New



**171.433**

**Citroën** C4 Picasso '06->

Ref.Adap. **6224.L1**

New



**171.434**

**PSA** Berlingo, Jumpy, Saxo, Xsara, Xsara Picasso, P-106, P-206, P-306, P-406, P-607, Expert, Partner

Ref.Adap. **6224.C0 / 9632162280**

New



**173.041**

**BMW** Serie 1 (E81/E82/E87/E88), Serie 3 (E90/E91), Serie 5 (E60/E61/F07/F10/F11), X5 (E70), Z4 (E89)

Ref.Adap. **63 11 6 938 563**

New



**173.080**

**VAG** A3, A4, Alhambra, Octavia, Caddy, Golf, Passat, Polo, Sharan, Touran, LT, Transporter, **Ford** Galaxy

Ref.Adap. **1J0 941 295 A / 1 044 664**

New



**173.196**

**VAG** A2, A4 '99, Q7, Arosa, Ibiza/Cordoba '99->'08, Leon/Toledo '99->'05, Golf IV y V, Lupo, Polo '99

Ref.Adap. **1J0 941 295 B**

New



**173.197**

**VAG** A3 '08->, Golf V y VI, Polo '05->, Touareg,

**Opel** Astra H, Insignia, Vectra C '02->'05, Signum

Ref.Adap. **1K6 941 295 / 6207109 / 13142042**

New



**175.224**

**Renault** Clio III, Espace IV, Kangoo, Laguna II y III, Megane II '05->, Modus, Scenic III '09->, Trafic II

Ref.Adap. **8200 402 521**

New



**175.225**

**Renault** Clio III, Espace IV, Laguna II '05, Megane II, Modus, Vel Satis

Ref.Adap. **8200 261 818**

**Faros XENON**

New



**175.226**

**Renault** Scenic II (Fase 2) 04/'06->'09, Twingo '07->, Master '10->

Ref.Adap. **8200 501 939**

New



**176.213**

**Nissan** Qashqai '06, Navara '05, Pathfinder '05, Primera '02->

Ref.Adap. **26056-AU300**

New



**178.098**

**VAG** Q5, Altea, Exeo, Ibiza '08, Leon/Toledo '05->, Polo '05->, **Opel** Corsa D, Meriva, Vectra C, Signum

Ref.Adap. **5P0 941 295 / 1207203 / 13129840**

New



**162.830**

**PSA** monta junto con 162756, 162757, 162758, 171434

Casquillo sujeción faro

Ref.Adap. **6224.80**



# BOMBAS Lavaparabrisas



**190.351** 2 salidas

Alfa Romeo, Fiat, Lancia  
Ref.Adap. 71719636 / 7688208



**190.352** 1 salida

Audi, Mercedes, Volkswagen  
Ref.Adap. 431 955 651 / 202 869 00 21



**190.353** 2 salidas

Audi, BMW, Mercedes, Seat, Volkswagen  
Ref.Adap. 1J6 955 651 / 210 869 00 21



**190.354** 1 salida

Audi  
Ref.Adap. 4A0 955 651 A



**190.355** 1 salida

BMW, Mercedes, Skoda, Smart  
Ref.Ad. 67128362154 / 2028690221 / 1J5955651



**190.356** 1 salida

BMW Serie 3 (E36), Serie 5 (E34), Z1, Z3  
Ref.Adap. 61 66 1 380 068



**190.357** 1 salida

Citroën, Peugeot  
Ref.Adap. 6434.46 / 6434.66



**190.358** 1 salida

Citroën, Fiat, Peugeot  
Ref.Adap. 6434.58 / 9601120180



**190.359** 2 salidas

Ford Fiesta '08, Focus '05, Volvo S40 '05, V50  
Ref.Ad. 1355124 / 1S7117K624AA / 31283805



**190.360** 2 salidas

Citroën, Fiat, Peugeot  
Ref.Adap. 6434.60 / 9612358180



**190.361** 2 salidas

Citroën, Peugeot, Renault  
Ref.Adap. 6434.75 / 7700 428 386



**190.362** 1 salida

Renault Clio II, Kangoo, Master, Megane  
Ref.Adap. 7700 431 079



**190.363** 1 salida

Honda, Hyundai, Kia, Mazda, Mitsubishi, Suzuki, Subaru, Toyota.  
Ref.Adap. 98510-29600



**190.364** 2 salidas

Fiat, Opel  
Ref.Adap. 46797755 / 14 50 175 / 90492357



**190.365** 1 salida

Daewoo, Ford, Honda, Hyundai, Suzuki, Toyota  
Ref.Adap. 38410-66113 / 6 140 949



**190.366** 1 salida

Ford  
Ref.Adap. 7 003 177 / 93BB-17K624-AA



**190.367** 2 salidas

Ford  
Ref.Adap. 7 003 178 / 93BB-17K624-BA



**190.368** 2 salidas

Ford, Opel, Volkswagen  
Ref.Adap. 7 222 079 / 1H6 955 651



**190.369**

Land Rover y Universal  
Ref.Adap. PRC 3369 / STC-575



**190.370** 1 salida

Mercedes  
Ref.Adap. 140 869 02 21 / 202 869 01 21



**190.371** 1 salida

Audi, Mercedes, Opel, Volkswagen  
Ref.Ad. 129 869 00 21 / 14 50 156 / 823 955 651

# BOMBAS Lavaparabrisas



**190.372** 2 salidas  
Ford, Opel, Seat, Volkswagen  
Ref.Adap. 14 50 173 / 14 50 185 / 1H5 955 651



**190.373** 1 salida  
Opel  
Ref.Adap. 14 50 184 / 90585761



**190.374** 2 salidas  
Renault  
Ref.Adap. 7700 430 702



**190.375** 2 salidas  
Renault  
Ref.Adap. 7701 048 307



**190.376** 1 salida  
Citroën, Peugeot, Renault  
Ref.Adap. 6434.70 / 7700 431 079



**190.377** 1 salida  
Renault  
Ref.Adap. 7700 802 336



**190.378** 2 salidas  
Seat, Volkswagen  
Ref.Adap. 1L0 955 651



**190.379** 1 salida  
Volkswagen, Volvo  
Ref.Adap. 1K5 955 651 / 9178094

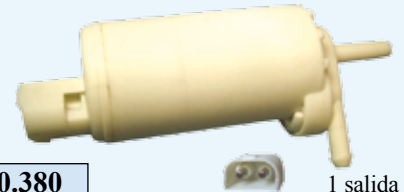

**190.380** 1 salida  
Volvo  
Ref.Adap. 9169611



**190.381** 1 salida  
BMW Serie 5 (E39) y Serie 7 (E38)  
Ref.Adap. 67 12 8 360 244

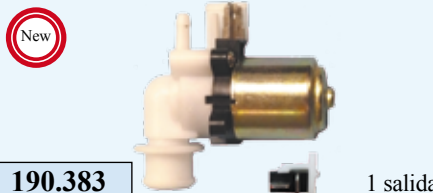

**190.383** 1 salida  
Citroën Jumper, Fiat Ducato, Peugeot Boxer  
Ref.Adap. 6434.67



**190.384** 1 salida  
Nissan Almera, Primera, Serena, Vanete, X-Trail  
Ref.Adap. 28920-50Y00

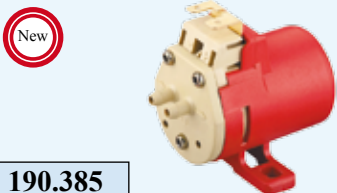

**190.385** 12 V  
Citroën C-15, Fiat, Lada, Peugeot y Universal  
Ref.Adap. 6434.22



**190.386** 24 V  
Universal  
Ref.Adap.



**190.387** 1 salida  
Renault R9, R11, R19, R21, Super 5  
Ref.Adap. 7704 002 215



**190.388** 1 salida  
Citroën, Dacia, Nissan Qashqai, Peugeot, Renault  
Ref.Adap. 6434.76 / 28920-BU010



**190.389** 2 salidas  
Opel  
Ref.Adap.



**190.390** 24 V  
Universal  
Ref.Adap.

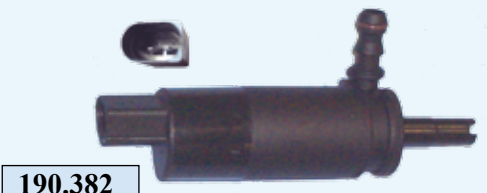

**190.382**  
BMW, Ford, Volkswagen  
Ref.Ad. 67126973097 / 3B7955681 / 1209387

## BOMBA lavafaros

# TUBOS EMPALMES

2 vías, Ø 3 x 3



**190.501**  
(U.E.=10)

2 vías, Ø 3 x 5



**190.502**  
(U.E.=10)

2 vías, Ø 4 x 5



**190.503**  
(U.E.=10)

2 vías, Ø 5 x 5



**190.504**  
(U.E.=10)

2 vías, Ø 5 x 5



**190.517**  
(U.E.=10)

2 vías, Ø 5 x 5 «corto»  
con válvula



**190.505**  
(U.E.=10)

2 vías, Ø 5 x 5 «largo»  
con válvula



**190.506**  
(U.E.=10)

2 vías, Ø 3 x 5  
con válvula



**190.512**  
(U.E.=10)

2 vías, Ø 5 x 5  
con válvula



**190.507**  
(U.E.=10)

2 vías, Ø 5 x 5  
con válvula



**190.515**  
(U.E.=10)

3 vías, Ø 4 x 4 x 5



**190.516**  
(U.E.=10)

3 vías, Ø 5 x 5 x 5



**190.508**  
(U.E.=10)

3 vías, Ø 5 x 5 x 5



**190.518**  
(U.E.=10)

3 vías, Ø 5 x 5 x 5



**190.519**  
(U.E.=10)

3 vías, Ø 5 x 5 x 5  
con válvula



**190.510**  
(U.E.=10)

3 vías, Ø 6 x 6 x 6  
con válvula



**190.513**  
(U.E.=10)

3 vías, Ø 5 x 5 x 5  
con válvula



**190.509**  
(U.E.=10)

3 vías, Ø 6 x 6 x 6  
con válvula



**190.514**  
(U.E.=10)

3 vías, Ø 5 x 5 x 5  
con válvula



**190.511**  
(U.E.=10)



**U.E.\***

**DESCRIPCION**

**Ref. Adaptable**

1 Expositor vacío ( 4 bandejas a distribuir por el cliente)

**180.501**

1 Expositor «surtido fijaciones plásticas», compuesto de:

**180.512**

bandeja 1 botones fijación (1)	bandeja 2 botones fijación (2)	bandeja 3 tacos plástico	bandeja 4 remaches plástico
100 x 162643 (Ø 6,5) 50 x 162660 (Ø 7) 100 x 162221 (Ø 7) 100 x 162211 (Ø 7,5) 100 x 162580 (Ø 8)	50 x 162512 (Ø 9) 25 x 162656 (Ø 10) 50 x 162613 (Ø 11) 25 x 163008 (Ø 11)	100 x 162326 ( 6) 50 x 162331 ( 7) 25 x 162775 ( 7) 100 x 162238 ( 7) 50 x 162715 ( 7) 50 x 162774 ( 7x7,5) 50 x 163211 ( 8) 100 x 162649 ( 8,5) 25 x 162480 ( 9,5) 50 x 162811 ( 10)	100 x 162431 (Ø 3,5) 100 x 162647 (Ø 5) 100 x 162819 (Ø 6) 50 x 162979 (Ø 6,5) 50 x 162505 (Ø 7) 50 x 162373 (Ø 8) 100 x 162341 (Ø 8,5)

Ø 4,8 x 15  
arandela Ø 15



161.473

Ø 4,8 x 18  
arandela Ø 15



161.474

Ø 5,5 x 19  
arandela Ø 22



161.742

Ø 6,3 x 19  
arandela Ø 18



162.556

Ø 6,3 x 19  
arandela Ø 22



161.743

Ø 6,3 x 14



161.739



161.787



161.714



161.772



161.715



161.716



161.717

Ø 3,9



161.490

Ø 4,2



161.493

Ø 4,2



161.427

Ø 4,8



161.495

Ø 4,8



161.788

Ø 4,8



161.498

Ø 4,8

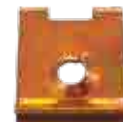

161.702

Ø 5,6



161.704

U.E.	DESCRIPCION	Ref.	Adaptable
50	Clip fijac. parachoques tras. serie 5 (E60) (ver Opel, Renault, VAG)	161.427	23 07 0 22
50	Tornillo Ø 4,8 x 15 (aro Ø 15), varios usos (ver varias marcas)	161.473	51 13 1 823 634
50	Tornillo Ø 4,8 x 18 (aro Ø 15), varios usos (ver varias marcas)	161.474	07 11 9 916 949
50	Clip fijac. varios usos BMW - varios modelos - (ver Ford)	161.490	07 12 9 925 726
50	Clip fijac. varios usos BMW - varios - (ver Ford, Mercedes)	161.493	07 12 9 925 708
50	Clip fijac. varios usos BMW - varios modelos -	161.495	07 12 9 925 712
50	Clip fijac. guardabarros BMW - varios modelos - (ver Mercedes, VAG)	161.498	07 12 9 925 713 07 12 9 901 649
50	Clip fijac. guardabarros s.3 (E30), tapizados maletero s.5 (E34) y tapizados interiores s.5 (E39) (ver Mercedes)	161.702	07 12 9 925 737
50	Clip fijac. varios usos BMW - varios modelos - (ver Ford, Opel)	161.704	07 12 9 925 720
10	Tuerca fijación pasoruada y tapa motor s.5 (E39), s.7 (E38), Z8 (E52)	161.714	51 71 8 176 503
10	Tornillo fijación insonorizantes motor serie 3 (E46) (ver Mini)	161.715	51 71 8 212 148
10	Tornillo fijación tapa motor serie 5 (E39), serie 7 (E38), Z8 (E52)	161.716	51 71 8 218 323
10	Tornillo fijación tapa motor serie 5 (E39), serie 7 (E38)	161.717	51 71 8 218 852
25	Tornillo fijación varios usos BMW - varios modelos -	161.739	41 35 8 152 737
50	Tornillo Ø 5,5 x 19 (aro Ø 22), fijac. guardabarros (ver varias marcas)	161.742	
50	Tornillo Ø 6,3 x 19 (aro Ø 22), fijac. guardabarros (ver varias marcas)	161.743	
10	Tuerca fijación insonorizante motor serie 3 (E46), serie 5 (E60/E60N/E61/E61N), Z4 (E86) (ver Mini, VAG)	161.772	51 71 8 212 164 07 14 6 981 767
25	Clip fijac. parachoques delantero y trasero X3 '03->'10 (E83/E83N)	161.787	51 12 3 413 810
50	Clip fijac. varios usos -varios vodelos-	161.788	07 12 9 904 150 07 12 9 901 656
50	Tornillo Ø 6,2 x 19 (aro Ø 18), sujeción guardabarros (ver Ford, Mercedes, Opel, VAG)	162.556	12 13 8 530 118 07 11 9 916 967

\* (imagen 1/2 tamaño real)



190.353\*



190.355\*



190.356\*



190.381\*



190.382\*

\* (imagen 1/2 tamaño real)



162.294

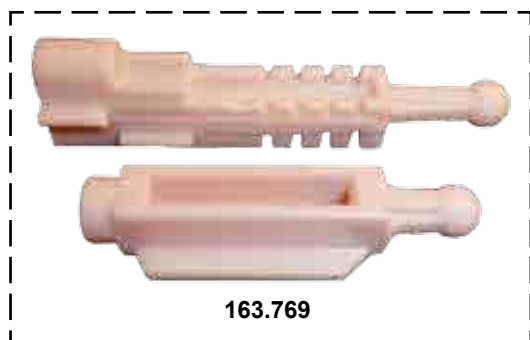

163.769



163.844



173.041

U.E.	DESCRIPCION	Ref. Adaptable
50	Casquillo regulador faro BMW (ver VAG)	162.294
1	Kit fijación regulador faro serie 5 (E39) '95->'00	163.769 ●63 12 0 027 924
10	Fijac. tornillo de ajuste faro serie 3 (E36), serie 6 (E63/E64), Z3	163.844 ●63 12 1 387 026
1	Regulador eléctrico faro serie 1 (E81/82/87/88), serie 3 '05 (E90/91), serie 5 '02 (E60/61, F07/10/11), X5 (E70), Z4 (E89)	173.041 ●63 11 6 938 563
1	Bomba lavaparabrisas serie 3 (ver Mercedes, VAG)	190.353
1	Bomba lavaparabrisas serie 3 (E36 11/97-> y E46), X3 (E83 y E83N), X5 (E53), Z3, Z4 (ver Mercedes, Smart, Skoda -VAG-)	190.355 67 12 8 362 154
1	Bomba lavaparabrisas serie 3 (E36 ->11/97), serie 5 (E34), Z1, Z3	190.356 61 66 1 380 068
1	Bomba lavaparabrisas serie 5 (E39), serie 7 (E38)	190.381 ●67 12 8 360 244
1	Bomba lavafaros -todos los modelos- (ver Ford, VAG)	190.382 ●67 12 6 973 097

\* U.E.: Unidad de Envase

New 2009 ●

New 2010 ●

New 2011 ●



161.784



161.773



161.774



161.775



161.776



161.783



161.785



161.786



163.950



163.951



163.809



163.816



163.865



163.749



163.801



163.949



163.817

U.E.	DESCRIPCION	Ref. Adaptable
25	Fijación parachoques trasero serie 1 (E82/E88), parachoques delantero Z4 (E85/E86)	161.773 ● 51 12 7 164 686
50	Fijación varios usos BMW - varios modelos - (ver Mini)	161.774 ● 07 12 9 901 746 07 12 9 925 770
25	Fijación marco puerta trasera serie 1 (E87/E87N), y X1 (E84)	161.775 ● 51 35 7 135 518
25	Fijación cubierta superior parabrisas X5 (E53) '00->'07	161.776 ● 51 71 7 012 032
50	Fijación insonorizante motor X3 '09-> (F25) (ver Mini)	161.783 ● 51 41 2 756 212
25	Fij. pasoruada y bajos serie 3 (E46), fij. parachoques trasero serie 1 (E81/87), serie 3 (E92/93), X1	161.784 ● 07 14 7 154 227
25	Fijación embellecedor parachoques trasero serie 6 (F12), X6 (apertura estrecha) (ver Mini)	161.785 ● 07 14 7 054 461
25	Fijación embellecedor parachoques trasero X3 (F25) (apertura ancha)	161.786 ● 07 14 9 241 763
25	Fijac. moldura vierteaguas puerta serie 3 '98->'04 (E46)	163.749 ● 51 13 8 204 858
25	Fijac. junta moldura puerta serie 3 '04-> (E90 / E91)	163.801 ● 51 13 7 117 240
10	Fijac. moldura techo serie 5 '02-> (E60 / E60N)	163.809 ● 51 13 7 064 097
10	Fijac. moldura techo serie 5 Touring '05-> (E61/E61N), X3 '09-> (F25), X5 '07-> (E70/E70N), X6	163.816 ● 51 13 7 070 747
5	Fijac. moldura techo serie 5 Touring '05-> (E61/E61N), X5 '07-> (E70/E70N)	163.817 ● 51 13 7 073 399
10	Fijac. moldura techo serie 5 Touring '05-> (E61/E61N)	163.865 ● 51 13 7 073 396
25	Fijac. moldura techo X1 (E84)	163.949 ● 51 13 2 992 450
25	Fijac. junta puertas X5 '00->'07 (E53)	163.950 ● 51 33 7 052 945
25	Fijac. junta puertas y junta frontal capó X5 '00->'07 (E53), serie 7 '02-> (E65/E66/E67/E68)	163.951 ● 51 71 7 006 757



U.E.	DESCRIPCION	Ref. Adaptable
25	Fijac. parabrisas serie 5 ->'95 (E34) y serie 7 ->'94 (E32) (Eurocode 2426/2427ASCS)	<b>162.945</b> 51 31 1 938 494 51 31 8 177 850
50	Fijación rejilla lavaparabrisas serie 5 (E34), serie 7 (E32), Z1 (Eurocode 2427ASCBS)	<b>163.056</b> 51 71 1 928 946
10	Fijac. moldura cristal serie 7 ->'01 (E38) (Eurocode 2433ASCS)	<b>163.058</b> 51 31 8 125 892
25	Fijac. rejilla radiador serie 3 (E36), serie 5 (E34), serie 7 (E38) (Eurocode 2431ASCBS7B)	<b>163.078</b> 51 71 8 108 613
25	Fijac. moldura parabrisas serie 3 '04-> (E90/E91) (Eurocode 2447ASCSS)	<b>163.347</b> 51 13 7 145 109
10	Fijac. moldura derecha parabrisas serie 3 '04-> (E90/E91) (Eurocode 2447ASCSS1B)	<b>163.348</b> 51 13 7 172 103
10	Fijac. moldura izquierda parabrisas serie 3 '04-> (E90/E91) (Eurocode 2447ASCSS2B)	<b>163.349</b> 51 13 7 145 110
25	Fij. moldura parabrisas serie 5 '02-> (E60/E61), X5 '07-> (E70) y X6 (Eurocode 2445ASCSS)	<b>163.456</b> 51 31 7 064 098
25	Fij. moldura lateral parabrisas X5 '07-> (E70) (Eurocode 2452ASCBS)	<b>163.711</b> ● 51 13 7 177 926
10	Fij. moldura lateral parabrisas X5 '07-> (E70) y X6 (Eurocode 2452ASCBS2B)	<b>163.712</b> ● 51 31 7 177 029
10	Fij. moldura lateral parabrisas X3 '03->'10 (E83/83N) (Eurocode 2449ASCBS)	<b>163.733</b> ● 51 31 3 448 374 51 31 3 401 691
10	Fij. moldura lateral parabrisas (parte inferior) serie 7 '07-> (F01/02/03/04) (Eurocode 2457ASCSDS)	<b>163.775</b> ● 51 13 7 157 702
10	Fij. moldura parabrisas (parte media) y luneta tras. s.7 (F01/02/03/04) (Eurocode 2457ASCSDS1B)	<b>163.776</b> ● 51 13 7 217 789
10	Fij. moldura techo - parabrisas serie 7 '07-> (F01 / F02 / F03 / F04)	<b>163.777</b> ● 51 13 7 184 575
10	Fij. moldura lateral parabrisas serie 5 '09-> (F10 / F11) (Eurocode 2459ASCSDS)	<b>163.796</b> ● 51 13 7 209 821
10	Fij. moldura parabrisas - techo serie 5 '09-> (F10 / F11)	<b>163.797</b> ● 51 13 7 238 257
25	Fij. moldura techo - parabrisas s.1 (E81/E82), s.3 Coupé '06-> (E92), s.5 Gran Turismo '08-> (F07)	<b>163.863</b> ● 51 76 7 162 587
10	Fij. moldura lateral parabrisas X3 '10-> (F25), fij. mold luneta trasera - techo s.7 (F01/F02/F04)	<b>163.952</b> ● 51 13 7 232 420





162.918



163.062



163.290



163.365



163.460



163.394



163.772



163.842



163.558\* - Dcho./Izdo



163.055



163.153



163.554\* - Dcho.  
163.555\* - Izdo.

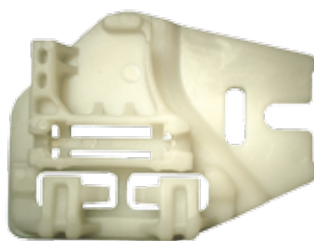

163.556\* - Dcho.  
163.557\* - Izdo.



163.654\* - Dcho.  
163.655\* - Izdo.

\* (imagen 1/2 tamaño real)

U.E.	DESCRIPCION	Ref. Adaptable	
10	Fijac. cableado BMW - varios modelos - (ver Ford, Opel)	162.918	
10	Fijación elevallunas serie 3 (E36 y E92), serie 5 (E34), Z3, Z4 (Eurocode 2431LSGSFD)	163.055	51 32 1 938 884
25	Fijac. varilla puerta serie 3 (E36), serie 5 (E34 y E39), serie 7 (E32 y E38) y Z3	163.062	51 22 1 817 032
10	Fijac. spoiler delantero serie 3 (E30)	163.153	51 71 1 945 568
50	Boca fijac. molduras serie 3 (E36 y E46), serie 5 (E39), serie 7 (E38)	163.290	51 13 1 960 127
50	Boca fijac. molduras serie 1 (E87), serie 3 (E46, E90, E91, E92), s.5 (E60 y E61), s.6 (E63 y E64), s.7 (E65, E66 y E67), X3 (E83/N)	163.365	51 71 1 932 996
50	Boca fijac. molduras laterales (ver Fiat y VAG)	163.394	
50	Boca fijac. emblemas BMW - todos los modelos -	163.460	51 14 1 807 495
1	Soporte cristal elevallunas delantero derecho serie 3 (E46)	163.554	
1	Soporte cristal elevallunas delantero izquierdo serie 3 (E46)	163.555	
1	Soporte cristal elevallunas trasero derecho serie 3 (E46)	163.556	
1	Soporte cristal elevallunas trasero izquierdo serie 3 (E46)	163.557	
1	Soporte (aluminio) cristal elevallunas trasero dcho./izdo. serie 5 (E39)	163.558	
1	Soporte cristal elevallunas delantero derecho X5 '00->	163.654	
1	Soporte cristal elevallunas delantero izquierdo X5 '00->	163.655	
50	Fijac. moldura puerta-techo serie 1 (E81/82), serie 3 (E46, E92/93), serie 5 (F07), serie 6 (E63/64), serie 7 (E38), X5 (E53)	163.772	51 31 8 150 943
50	Fijac. moldura talonera s.3 (E30), s.5 (E34), s.7 (E32/E38), fij. moldura marco puerta serie 5 (E39)	163.842	51 13 1 934 160



163.292



163.457



163.458



163.819



162.943



162.944



163.289



163.748



163.821



163.774



163.459



163.862



163.110

U.E.	DESCRIPCION	Ref. Adaptable
10	Fijac. molduras serie 3 (E36 y E46)	162.943 51 13 1 960 054
10	Fijac. molduras serie 5 (E39) y serie 7 (E38) (ver Fiat, Opel)	162.944 51 13 8 166 675
10	Fijac. moldura talonera serie 3 (E36 y E46)	163.110 51 71 8 184 574
10	Fijac. molduras serie 3 (E36)	163.289 51 13 2 251 394
10	Fijac. molduras serie 5 (518, 520, 524, 525, 528, 535, M5), 630, 635	163.292 51 13 1 875 898
25	Fijac. moldura talonera serie 1 (E81/82/87/88), serie 3 (E90/91/92/93), serie 6 (F12), X1 y X6 (monta con 163.458)	163.457 07 14 7 122 912
25	Fijac. moldura talonera serie 1 (E81/82/87/88), serie 3 (E90/91/92/93), serie 6 (F12), X1 y X6 (monta con 163.457)	163.458 07 14 7 122 913
25	Fijac. moldura talonera s.3 Coupé / Cabrio (E92 / E93), s.6 (E63 y E64)	163.459 51 77 7 170 955
10	Fijac. moldura lateral puerta serie 3 '98->'04 (E46)	163.748 51 13 8 231 130
25	Fijac. moldura talonera serie 3 '04-> (E90 / E91)	163.774 51 77 7 166 869
25	Fijac. moldura talonera serie 3 Coupé / Cabrio '06-> (E92 / E93)	163.819 07 14 6 965 447
25	Fijac. moldura talonera serie 3 '04-> (E90 / E91)	163.821 51 77 7 891 250
25	Fijac. moldura talonera serie 5 '02-> (E60 / E61)	163.862 51 71 7 066 223



U.E.	DESCRIPCION	Ref.	Adaptable
50	Fijac. revestimientos interiores E23, E24, E28 (ver Ford, Opel, VAG)	162.782	51 47 1 904 317
50	Fijac. pasoruedas, revestimientos y otros usos serie 1 (E87), serie 3 (E90/E91/E92), Z3 (ver VAG)	162.921	51 71 1 958 025
50	Fijac. revestimientos s.3 (E36 y E46), s.7 (E65, E66, E67 y E68), X3 (E83 y E83N), X5 (E53) y Z4 (ver Ford, Mini, Opel, VAG)	162.948	16 13 1 176 747
25	Taco para fijac. tornillo Ø 3,5 serie 5 (E34) (ver Mercedes)	163.063	51 13 8 102 952
50	Fijac. pasoruedas y revestim. s.1 (E87), s.3 (E36, E46, E90, E91, E92), s.5 (E34, E39, E60, E61), s.7 (E65, E66, E67, E68), X3, X5 (E53) (ver Mercedes, Mini)	163.288	16 13 1 176 747
50	Fijac. revestimientos maletero serie 3 (E91) y serie 5 (F07) (ver VAG)	163.350	07 14 6 969 296
50	Fijac. pasoruedas serie 1 (E87), s.3 (E36, E46, E90, E91, E92), s.5 (E34, E60, E61) (ver Mini)	163.454	51 16 1 943 122
50	Fijac. pasoruedas serie 1 (E87), serie 3 (E36, E46, E90, E91, E92), serie 7 (E65, E66, E67), X3 (E83, E83N), X5 (E53), Z3, Z4	163.455	51 71 1 958 025
25	Fijac. moldura talonera serie 5 (E34 / E39)	163.770	51 47 8 234 047 51 47 1 928 808
50	Fijac. moldura pasoruada X3 (E83), fijac. talonera serie 3 (E30/E46), serie 5 (E28), X3	163.820	51 71 1 927 439
25	Fijac. faldón entrada puerta serie 3 Coupé (E92)	163.822	51 47 8 413 209
25	Fijac. moldura protección entrada puerta trasera serie 1 (E81/E82/E87), serie 3 (E90/91/93), serie 5 (E60/E61), serie 6 (E63/E64), x3 '09-> (F25), X5 '07-> (E70), X6	163.825	51 47 7 117 532
25	Fijac. moldura exterior pilar B serie 1 (E87/E87N) (ver Mini)	163.826	51 33 7 140 714
10	Fijac. moldura pasoruada X3 '09-> (F25), fijac. talonera puerta serie 7 (E38)	163.828	51 71 8 259 025
50	Fijac. faldón entrada puerta serie 1 (E82/88), serie 3 (E36/E46), s.5 (E34/E39/E60/61/F10/F11), serie 6 (E63/64), serie 7 (E38/E65/66/67/68/F01/02/03), X1, Z3, Z4	163.840	51 47 1 840 960
25	Fijac. faldón puerta serie 3 (E21/E30/E36)	163.841	51 47 1 840 961
25	Fijac. soporte matrícula trasero serie 3 (E46), serie 5 (E60), X5 (E53) (ver Mini)	163.848	51 18 8 242 693
50	Fijac. faldón entrada puerta serie 3 (E46/E90/E91/E93), serie 5 (E60/E61/F07)	163.928	51 47 8 244 458



162.235



163.059



163.060



163.465



163.773



163.751



163.849



163.747



163.750



163.752



163.843



163.753



163.818



161.420



163.829



163.823



163.061



163.746



163.077

U.E.	DESCRIPCION	Ref. Adaptable
50	Fijación revestimientos maletero serie 3 (E36 y E46), serie 5 (E34 / E39 y E61), fijac. tapizados interiores serie 7 (E65/66), X3 (ver Ford, Mini)	161.420 51 49 8 123 832
50	Fijac. panel puerta BMW - varios modelos - (ver Ford, VAG)	162.235
50	Fijac. panel puerta serie 3 (E36 y E46), serie 5 (E34 y E39), serie 7 (E38), X5 (E53), Z3 y Z8	163.059 51 41 1 973 500 51 51 8 172 050
25	Fijac. panel puerta serie 5 (E39)	163.060
50	Fijac. tapizados interiores serie 3 (E36), serie 5 (E34 y E39), s.7 (E32)	163.061 51 48 8 181 420
25	Fijac. cierre rápido BMW - todos los modelos -	163.077 51 71 1 916 197
25	Fijac. tapizados puerta serie 3 (E36)	163.465 51 41 2 155 030
25	Fijac. alfombrillas serie 3 (E46), serie 5 (E34, E39), serie 7 (E32, E38)	163.746 82 11 9 710 191
25	Fijac. revestimientos interiores serie 3 (E46), X3 (E83), X5 (E53), Z4 (E85/E86)	163.747 51 43 8 225 567
25	Fijac. panel puerta s.1 (E82), s.3 (E46, E90/91/92/93), s.5 (E60N/61N), s.7 (E65/66/67, F01/02/03), X1, X3 (E83, F25), X5 (E53), X6 (ver Mini)	163.750 51 41 8 224 768
50	Fijac. panel puerta serie 5 (E39), Z8 (E52)	163.751 51 41 8 172 050
25	Fijac. panel puerta serie 1 (E88), serie 3 (E36 Cabrio, E46, E90/91/92/93), serie 5 (E60/E61), serie 6 (E63/E64), X1, X3 (E83, F25), X5 (E53, E70), X6 (ver Mini)	163.752 51 41 8 224 781
25	Fijac. panel puerta serie 5 (F07/F10/F11), serie 6 (F12), serie 7 (F01/F02), fijac. tapizados maletero X5 (E70) (ver Mini)	163.753 07 14 7 145 753
50	Fijac. panel puerta serie 3 (E36 Cabrio, E46), serie 7 (E32/E38) (ver Mercedes)	163.773 51 41 8 101 204
50	Fijac. revestimientos interiores serie 1 (E81/82/87), serie 3 (E90/91/92), serie 5 (F07/10/11), serie 7 (F01/02/03), X1	163.818 07 14 7 152 593
10	Fijac. tapizados puerta X3 '09-> (ver Mini)	163.823 51 25 2 753 575
25	Fijac. panel puerta serie 3 (E90N/E91N)	163.829 51 41 7 211 653
50	Fijac. panel puerta serie 3 (E46), fijac. revestimientos interiores serie 1 (E81/82/87/88), serie 3 (E90/91/92/93), s.5 (F07/10/11), s.7 (F01/02/03/04), X1, X3 (F25), X5 (E70), X6 (ver Mini)	163.843 51 43 7 001 491
25	Fijac. agarradero tapa maletero serie 3 (E46) (ver Mini)	163.849 07 17 7 141 218

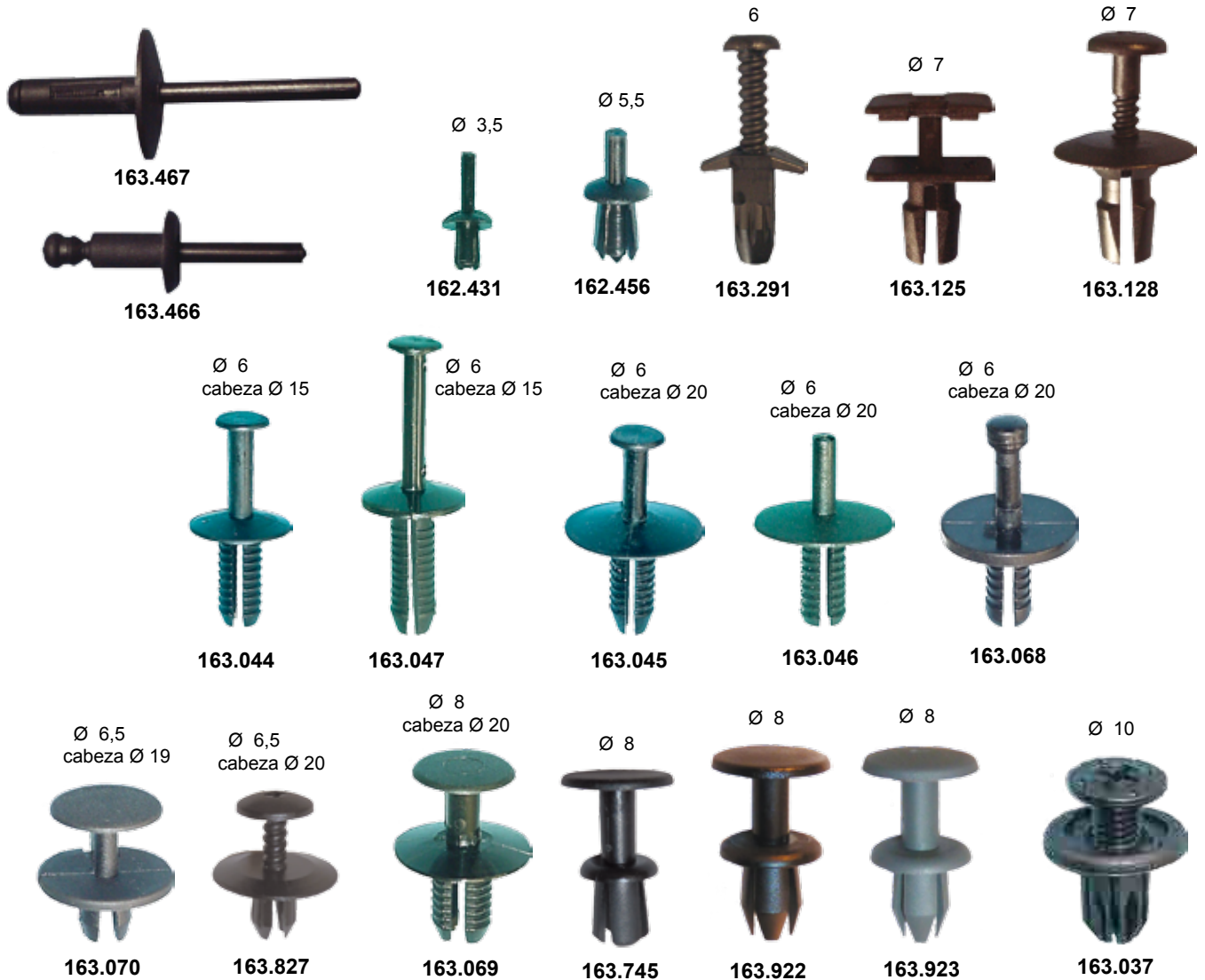

U.E.	DESCRIPCION	Ref. Adaptable
100	Remache fijac. varios usos (ver Opel, PSA, VAG)	162.431
50	Fijac. bajos carroceria serie 1 (E81,82,87,88), serie 3 (E90,91,92,93), X1, fij. pasoruada s.3 (E46), s.5 (E39,60,61,65,66,67, F01,02,03,04,07,10,11), s.6 (F12), Z4 (E89) (ver PSA y Renault)	162.456
10	Fijac. bajos carroceria serie 1 (E81, E82 y E88) (ver Daewoo, Honda, Mini, Rover)	163.037
50	Fijac. revest. interiores y parachoques - todos - (ver Mercedes, Mini, VAG)	163.044
50	Fijac. parachoques serie 3 (E46), s.5 (E39), s.7 (E38), X3 (E83/83N), X5 (E53), Z3 y Z4 (ver Mini)	163.045
50	Fijac. parachoques serie 3 (E36, E46), s.5 (E34, E39), s.7 (E38), X3 (E83/83N), X5 (E53), Z3 y Z8	163.046
50	Fijac. parachoques serie 3 (E30, E36, E46) , serie 5 (E39, E60), s.7 (E38), X5 (E53) (ver Opel)	163.047
25	Fijac. rápida - varios usos - serie 3 (E30), serie 5 (E28)	163.068
25	Fijac. rápida - varios usos - todos (ver Mercedes, Mini, Volvo)	163.069
25	Fijac. rápida - varios usos - serie 3 (E30, E34), serie 5 (E39), serie 7 (E32, E38, E65,66,67,68), Z3	163.070
25	Fijac. torpedo parabrisas BMW serie 3 (E36), s.7 (E38), Z3 (Eurocode 2431/2433/2435ASC/SB)	163.125
25	Fijac. torpedo parabrisas BMW serie 5 (E39), X5 (E53) (Eurocode 2434ASSH y 2434/2426ASC/SB)	163.128
50	Fij. rejilla lavaparabr. s.3 (E36), s.5 (E34/39/60/61), s.6 (E63, E64), s.7 (E38/65/66/67/68), X5 (E53)	163.291
25	Fijac. parachoques delantero serie 3 (E46) y talonera serie 3 (E30)	163.466
25	Fijac. pasoruada serie 3 (E90/E91 335i Touring), X1, X3 (E83/E83N), X5 (E53) y Z4 (E85/E86)	163.467
25	Fijac. tapizados interiores serie 1 (E81/E82/E87/E88), serie 3 (E36, E46, E92/E93), serie 5 (E39, E61), X6, Z3, serie 6 (E63/E64), serie 7 (E38, E65/E66)	163.745
50	Fijac. parachoques delantero serie 5 (E34), tapiz. maletero serie 3 (E36), serie 5 (E60), X5 (E53), fijac. insonorizante motor serie 3 (E46)	163.827
50	Fijac. revestim. maletero s.1 (E82/E88), s.5 (E60/60N y F07), s.6 (E63/64), X5 (E70), X6, Z4 (E89)	163.922
50	Fijac. revestim. maletero s.1 (E88), s.3 (E46 y E90/E92/E93), s.6 (E61/E61N), s.7 (F01/02/03/04)	163.923

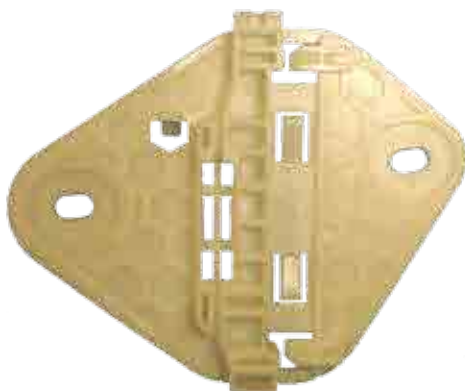

**163.666\*** - Dcho.  
**163.667\*** - Izdo.



**190.388\***

\* (imagen 1/2 tamaño real)

U.E.	DESCRIPCION	Ref. Adaptable
25	Tornillo Ø 6 x 20 (aro Ø 22), fijac. parachoques delantero Logan (ver Opel, Renault)	<b>161.724</b> 7703 602 206
25	Tornillo Ø 6 x 20 (aro Ø 18), fijac. aleta delantera Logan y Sandero (ver Opel, Renault)	<b>161.727</b> 7703 602 282
25	Tornillo Ø 6 x 28 (aro Ø 24), fijac. parachoques trasero Sandero (ver Renault)	<b>161.731</b> 7703 602 059
25	Tornillo Ø 5 x 22 (aro Ø 16), fijac. parachoques y moldura puerta Logan y Sandero (ver Opel, Renault)	<b>161.750</b> 7703 017 090
50	Fijac. panel puerta Logan, Sandero (ver Renault)	<b>161.779</b> 7703 046 143 7703 046 098
1	Soporte cristal elevalunas delantero derecho Dacia Logan	<b>163.666</b>
1	Soporte cristal elevalunas delantero izquierdo Dacia Logan	<b>163.667</b>
1	Bomba lavaparabrisas (ver Nissan, PSA, Renault)	<b>190.388</b> 6001 549 443



163.488



163.082



163.491



162.485



7 x 14  
Tornillo Ø 3,9

163.222



Ø 6,7

163.006



Ø 6,7

163.490



Ø 6,7

163.489



Ø 11

163.008



163.320



Ø 6

163.140



Ø 8,2

163.088



Ø 10

162.941



Ø 10

163.906

U.E.	DESCRIPCION		Ref. Adaptable
25	Fijac. varilla cerradura puerta Logan (ver PSA, Renault)	162.485	7703 079 290
25	Botón fijac. pasoruada Logan (ver PSA, Renault)	162.941	7703 081 054
50	Fijac. insonorizante capó y fijac. alfombras Logan, Sandero, Duster (ver Renault)	163.006	7703 077 117
50	Fijac. pasoruada y protector parachoques delantero Logan, Sandero, Duster (ver Renault)	163.008	7703 077 435
50	Fijac. panel puerta Logan (ver PSA, Renault, VAG, Volvo)	163.082	7701 056 846
50	Fijac. rejilla calandra y protector parachoques delantero Duster, Logan y Sandero (ver Nissan, Opel, Renault)	163.088	7703 072 360
50	Fijac. pasoruada Sandero (ver Fiat, Opel, Nissan, Renault)	163.140	7703 072 361
25	Taco fijac. revestimientos interiores Logan (ver Fiat, PSA, Opel, Renault)	163.222	7703 081 185
50	Fijac. insonorizantes y pasoruada Logan, Sandero y Duster (ver Renault)	163.320	7703 081 056
50	Fijac. molduras puerta Logan	163.488	
50	Fijac. tapizados interiores Logan (gris)	163.489	6001 546 909
50	Fijac. tapizados interiores Logan	163.490	
50	Fijac. panel puerta Logan	163.491	6001 549 265
25	Fijac. pasoruada trasero Duster, fijac. insonorizante y tapizados interiores Duster, Logan, Sandero (ver Renault)	163.906	7703 081 227

(imagen 1/2 tamaño real)



190.365\*



163.293



163.307



163.037



163.163

U.E.	DESCRIPCION	Ref. Adaptable
10	Fijac. parachoques Matiz, Nubira - y otros - (ver BMW, Honda, Mini, Rover)	163.037 94530623
10	Fijac. parachoques - varios modelos - (ver Honda)	163.163 94530624
25	Fijac. tapizados Matiz - y otros -	163.293 94530542
100	Fijac. tapizados y pasoruada - varios modelos - (ver Opel)	163.307 94530507
1	Bomba lavaparabrisas Lanos, Tico (ver Ford, Honda, Hyundai, Mitsubishi, Suzuki, Toyota)	190.365 38410-66113



163.263



163.264



163.265

U.E.	DESCRIPCION	Ref. Adaptable
10	Fijac. moldura pasoruada Feroza, Terios	163.263 90044-67395-000
10	Fijac. parrilla radiador Feroza, Terios	163.264 90044-67376-000
10	Fijac. bisagra puerta Feroza, Terios	163.265 90044-68025-000



# FIAT (ALFA ROMEO / FIAT / LANCIA)

Ø 3,9 x 25



**161.454**

Ø 4,5 x 19  
arandela Ø 12



**161.760**

Ø 4,8 x 22



**162.710**

Ø 4,8 x 20



**161.453**

Ø M5 x 11



**161.758**

Ø M6 x 11  
arandela Ø 14



**161.753**

Ø M6 x 17



**162.528**

Ø M6 x 16  
arandela Ø 15



**161.475**

Ø M6 x 18



**161.752**

Ø M6 x 18



**162.529**

U.E.	DESCRIPCION	Ref.	Adaptable
50	Tornillo fijac. revestimiento pasoruada Bravo/a, Marea, Punto y fijac. tapizados interiores Bravo/a, Ducato '94, Grande Punto '05	<b>161.453</b>	11877207 15691007
50	Tornillo fijac. panel puerta y revestimientos Alfa Romeo 147, Fiat Dobló, Multipla, Punto '99 y '03, Seicento, Lancia Y, Ypsilon	<b>161.454</b>	7751170
10	Tornillo fijación guardabarros Alfa Romeo 147	<b>161.475</b>	60652498
25	Tornillo fijac. parachoques Alfa Romeo 145, 146, 147, 156, 159, 166, Brera, Fiat Dobló, Ducato, Grande Punto, Marea, Multipla, Palio, Panda '03, Punto '99 y '03, Seicento, Siena, Strada, Lancia Lybra, Thesis, Y, Ypsilon	<b>161.752</b>	46419734
25	Tornillo fijac. elevallunas - todos los modelos modernos -	<b>161.753</b>	46401657
10	Tornillo fijac. manecilla puerta y portón trasero Alfa Romeo 147, Fiat Bravo/a, Dobló, Marea	<b>161.758</b>	46421193
25	Tornillo Ø 4,5 x 19 (aro Ø 12), fijac. plásticas varias (ver PSA)	<b>161.760</b>	
25	Tornillo fijac. guardabarros delantero Bravo/a, Dobló, Ducato, Punto '99, Lancia Lybra, Y	<b>162.528</b>	10707524 18770424
25	Tornillo fijac. parachoques Fiat Bravo/a, Dobló, Grande Punto '05, Marea, Punto '99 y '03, Lancia Kappa, Thesis, Y	<b>162.529</b>	7739729 7785196
50	Tornillo fijac. pasoruada y tapizados Alfa Romeo 147, 156, 166, Fiat Bravo/a, Cromo '05, Marea, Multipla, Punto '99 y '03, Tipo, Tempra, Lancia Lybra, Kappa, Y, Ypsilon	<b>162.710</b>	7630815 15690307

# FIAT (ALFA ROMEO / FIAT / LANCIA)

Ø M6 x 20



**161.706**

Ø M6 x 20



**161.456**

Ø M6 x 20



**161.457**

Ø M6 x 22



**162.526**

Ø M6 x 25  
arandela Ø 18



**161.723**

Ø M6 x (10+21)



**161.458**

Ø M8 x 10,5  
arandela Ø 17



**161.754**

Ø M8 x 20



**161.455**

Ø M8 x 16



**162.363**

Ø M8 x 20



**161.476**

Ø M8 x 20



**161.705**

U.E.	DESCRIPCION	Ref. Adaptable
10	Tornillo fijación travesa delantera Fiat Tipo, Tempra, Marea, fijac. guardabarros Bravo/a, Dedra, y parachoques Alfa Romeo 33	<b>161.455</b> 7609062
25	Tornillo fijac. guardabarros Tipo, Tempra, Marea, Bravo/a, Cinquecento, Nuevo Delta, Dedra	<b>161.456</b> 7558952
25	Tornillo en jaula fijac. guardabarros Uno, Bravo/a, Marea	<b>161.457</b> 14660690
10	Tornillo fijac. parachoques del. Bravo/a, Marea (monta con 162.893)	<b>161.458</b> 7771629
10	Tornillo fijac. bisagra puertas A. Romeo, Fiat, Lancia - modernos -	<b>161.476</b> 7789185
10	Tornillo fijac. parachoques Bravo/a, Punto, Tipo/Tempra (ver Renault)	<b>161.705</b> 18772114
50	Tornillo fijac. bisagra puerta Alfa Romeo 147, 155, 156, Fiat Bravo/a, Multipla, Punto '99 y '03, Tipo, Tempra, Lancia Delta, Lybra, Kappa, Y, Ypsilon (ver Renault)	<b>161.706</b> 7658843
25	Tornillo Ø 6 x 23 con aro móvil Ø 18, varios usos (ver PSA)	<b>161.723</b>
25	Tornillo fijac. cerraduras puerta Alfa Romeo 145, 146, 147, Fiat Dobló, Multipla, Punto '99 y '03, Seicento, Lancia Y	<b>161.754</b> 46401658
25	Tornillo fijac. parachoques Fiat Cinquecento, Uno, Punto, Bravo/a, Marea, Regata, Cromo, Ducato, Lancia Y-10, Thema, (monta con 162.359) (ver Seat)	<b>162.363</b> 16043324
25	Tornillo fijac. guardabarros Punto, Tipo, Tempra	<b>162.526</b> 7635233

# FIAT (ALFA ROMEO / FIAT / LANCIA)

20 x 20  
Tornillo Ø M6 x 22



162.356

20 x 20  
Tornillo Ø M8 x 18



162.357

20 x 20  
Tornillo Ø 8



162.359

13 x 18  
Tornillo Ø 6,3



162.393

Ø 6



162.696

Ø 6



162.697

Ø 6



162.465



161.448



163.095



163.096



163.097



161.751

U.E.	DESCRIPCION	Ref. Adaptable
50	Fijac. manecilla elevalunas Fiat Punto '97 (ver Seat)	161.448 4138439
25	Fijac. parachoques Alfa Romeo 147, 156, 159, Fiat Siena, Strada, y fijac. tapizados Fiat Dobló, fijac. rejilla radiador Fiat Cromo'05 y Palio	161.751 46790807
25	Tornillo fijac. parachoques Uno, Punto, Ducato (ver Seat)	162.356 7628035
25	Tornillo fijac. parachoques Uno, Regata, Y-10, Thema (ver Seat)	162.357 5940767 7569387
25	Tuerca fijac. parachoques Fiat Cinquecento, Cromo, Punto, Regata, Uno, Lancia Y-10 y Thema (monta con 162.363) (ver Seat)	162.359 5967727 7508973
50	Fijac. panel puerta Iveco (ver Ford, PSA, Renault)	162.465 14116890
10	Fijac. guardabarros Uno, Cromo, Regata, Y-10 2ª serie (ver Seat)	162.393 5979901
10	Fijac. guardabarros Alfa Romeo 145 / 146 / 155, Fiat Tipo, Tempra, Lancia Delta, Dedra	162.696 7623058
10	Fijac. guardabarros Alfa Romeo 145 / 146 / 155, Fiat Cinquecento, Seicento, Cromo, Tipo, Tempra, Lancia Delta, Nuevo Delta, Dedra	162.697 7622939
10	Fijac. faros delanteros Fiat Dobló, Alfa Romeo 156, fijac. rejilla radiador Fiat Cromo, Lancia Delta, Alfa 33 y fijac. tapizados interiores Barchetta, Cinquecento, Marea, Marengo	163.095 82435506 60517025
10	Fijac. tapizados interiores y rejilla radiador Alfa Romeo 145, 146, 156 y fijac. parachoques delantero Alfa Romeo 156	163.096 60584337
10	Fijación parrilla radiador Fiat 500 '07->, fijación spoiler bajo puerta Alfa Romeo 156, 164 y fijac. tapizados interiores Barchetta, Alfa Romeo 145, 146, 147, 156, 164, 166	163.097 60507674

# FIAT (ALFA ROMEO / FIAT / LANCIA)



U.E.	DESCRIPCION	Ref. Adaptable
50	Clip fijac. pasoruada Alfa Romeo 147, 159, 166, Fiat Bravo/a, Punto '99 y '03, Lancia Lybra, Kappa, Y	161.411 14368974
25	Tuerca fij. revestimientos interiores Alfa Romeo 147, 159, GT, Fiat Bravo/a, Marea, Punto '99 y '03, Stilo, Lancia Dedra y Nuevo Delta (ver VAG)	161.459 82488491
50	Clip fijac. montante Alfa Romeo 146, 155, 166, Fiat Bravo/a, Dobló, Ducato, Marea, Palio, Stilo, Tipo, Lancia Lybra, Y	161.464 60808479 7740882
25	Fijac. moldura pasoruada Bravo '07, Dobló, Palio, Siena, Stilo, Strada	161.485 46428157
50	Clip fijac. panel puerta Fiat Stilo, Lancia Y, fijac. parachoques Barchetta, Palio, fijac. tapizados Fiat Dobló, Multipla y fijac. faros antiniebla Alfa Romeo 156, 159	161.488 7729424
50	Clip fijac. faro antiniebla Panda 2003, panel puerta Lancia Lybra	161.701 14188971
50	Clip fijac. parachoques Alfa Romeo 147, 156, GT	161.759 14228471
50	Remache Ø 2,4 x 5, varias aplicaciones Cinquecento, Uno, Tipo, Tempra, Ducato, Alfa Romeo (ver Ford, Opel, PSA, Renault, V.A.G.)	162.362
25	Boca fijac. guardabarros Alfa Romeo 147, 156, 159, Fiat Bravo/a, Cinquecento, Dobló, Ducato, Marea, Seicento, Stilo, Palio, Punto, Punto '03, Grande Punto '05, Lancia Lybra, Y-10, Y (ver PSA)	162.439 15624411
50	Clip fijac. guardabarros Fiat Bravo (ver PSA, Renault, VAG)	162.442 60811807
50	Clip fijac. faro Fiat Bravo/a, Marea	162.444 46473571
25	Boca fijac. guardabarros Fiat Bravo/a, Marea, Punto	162.525 7678439 7781538
25	Boca fijac. guardabarros Alfa Romeo 145, 146, 147, 156, Fiat Bravo/a, Cromo'05, Marea, Punto, Punto '03, Strada, Uno, Lancia Y-10, Y	162.527 7677561

# FIAT (ALFA ROMEO / FIAT / LANCIA)



184.867\*



184.868\*



181.413\*



182.312\*



181.416\*



162.390

\* (imagen NO a tamaño real)



161.408



162.406



162.524



164.381



164.382

U.E.	DESCRIPCION	Ref.	Adaptable
5	Tope (goma) capó Uno	161.408	7635984
10	Fijac. tirante bandeja trasera Fiat Uno, Punto, Palio, Lancia Y, Ypsilon, Alfa Romeo 33	162.390	7670683
5	Tope (goma) capó y portón Alfa Romeo 155, Fiat Cinquecento, Tipo, Tempra, Cromo, Ducato, Lancia Dedra, Nuevo Delta, Kappa	162.406	7603637
5	Tope (goma) capó y portón Alfa Romeo 147, 156, Fiat Bravo/a, Dobló, Marea, Punto -todos-, Palio, Seicento, Lancia Lybra, Y	162.524	7781964
5	Tope (goma) capó y portón Uno, Y-10 (ver PSA, Renault)	164.381	4276430
5	Tope (goma) portón Bravo/a	164.382	7787498
-	Tirante bandeja posterior Fiat Uno Restyling (long.total 280 mm.)	181.413	7671135
-	Tirante bandeja posterior Fiat Alfa Romeo 145/146, Fiat Brava (long.total 280 mm.)	181.416	60812237
-	Tirante bandeja posterior Alfa Romeo 147, Fiat Punto (long.total 345 mm.)	182.312	7740229
-	Tirante bandeja posterior Fiat Uno (long.total 345 mm.)	184.867	
-	Tirante bandeja posterior Fiat Uno (long.total 370 mm.)	184.868	7561909

# FIAT (ALFA ROMEO / FIAT / LANCIA)



190.351\*



190.358\*



190.360\*

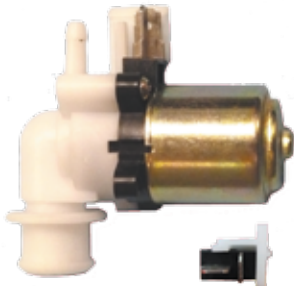

190.383\*



190.385\*



190.364\*

\* (imagen 1/2 tamaño real)



163.852



163.837



163.248



162.890



162.965



163.867



163.920



163.425

U.E.	DESCRIPCION	Ref. Adaptable
10	Base posicionador parabrisas Fiat Bravo/a, Cromo '05, Dobló, Marea, Multipla, Palio, Punto, Stilo, Lancia Y (Eurocode 3354ASCVB)	162.890 7734476
10	Base posicionador parabrisas Alfa Romeo 147, Mito, Fiat 500 '07, Bravo/a, Marea, Panda 2004, Punto '99 y '03 y Evo, Grande Punto '05, Lancia Ypsilon (Eurocode 3359ASCH6B)	162.965 46541864
10	Fijac. rejilla parabrisas "torpedo" Sedici '06-> (Eurocode 3363ASCR) (ver Suzuki, Toyota)	163.248
10	Base soporte parabrisas Iveco Daily (Eurocode 7247ASCV) (ver Renault)	163.425 504085696
50	Fijac. rejilla parabrisas "torpedo" Fiat Stilo '01-> (Eurocode 3355ASCHB)	163.837 14591987
10	Fijac. moldura inferior parabrisas Sedici '06-> (Eurocode 6291ASCV) (ver Opel, Suzuki)	163.852 51819230
10	Fijac. soporte inferior parabrisas Ducato II '02->'06 (ver PSA)	163.867 1314167080
10	Fijac. rejilla parabrisas "torpedo" Alfa Romeo 159, Brera, Fiat Ducato III '06 (ver PSA)	163.920 60697869
1	Bomba lavaparabrisas Alfa Romeo 145, 146, 147, 156, Fiat Bravo/a, Dobó, Idea, Punto, Stilo, Lancia Delta, Dedra, Musa, Ypsilon	190.351 71719636 7688208
1	Bomba lavaparabrisas Scudo (ver PSA)	190.358 9601120180
1	Bomba lavaparabrisas Ulysse (ver PSA)	190.360 9612358180
1	Bomba lavaparabrisas Fiat Multipla, Palio, Punto, Tipo, Delta, Dedra, Musa, Ypsilon (ver Opel)	190.364 46797755 7682336
1	Bomba lavaparabrisas Ducato (ver PSA)	190.383
1	Bomba lavaparabrisas -varios modelos- (ver PSA)	190.385

# FIAT (ALFA ROMEO / FIAT / LANCIA)



190.001



190.002



190.003



190.004



190.005



190.006



190.009



190.027



190.028



190.029



190.033



190.037



190.038

U.E.	DESCRIPCION		Ref. Adaptable
5	Surtidor lavaparabrisas Alfa Romeo 33	190.001	60503854
5	Surtidor lavaparabrisas Fiat Uno ->'90	190.002	5942690
5	Surtidor lavaparabrisas Fiat Uno '90.>	190.003	7641846
5	Surtidor lavaparabrisas Fiat Ducato, Talento, Tipo	190.004	7586380
5	Surtidor lavaparabrisas A.Romeo 145/146, 155, Fiat Tipo, Tempra	190.005	7679491
5	Surtidor lavaparabrisas Fiat Punto, Lancia Y	190.006	7769348
5	Surtidor lavaparabrisas Fiat Croma, Ducato, Lancia Thema, Y-10	190.009	4389370
5	Surtidor lavaparabrisas Fiat Bravo/a, Marea	190.027	7767818
5	Surtidor lavaparabrisas Fiat Cinquecento, Seicento	190.028	182036080
5	Surtidor lavaparabrisas Fiat Punto '99->, Dobló, Ducato'02, Panda'03	190.029	735277664
5	Surtidor lavaparabrisas Fiat Ducato '94->	190.033	1301155080
5	Surtidor lavaparabrisas Alfa Romeo 147	190.037	46765852
5	Surtidor lavaparabrisas Fiat Punto 2003->	190.038	735360838

# FIAT (ALFA ROMEO / FIAT / LANCIA)



190.039



190.040



190.046



190.047



190.048



190.049



190.050



190.051



190.052



190.053



190.054



190.055

U.E.	DESCRIPCION		Ref. Adaptable
5	Surtidor lavaparabrisas Alfa Romeo 147 '00->	190.039	51702444
2	Surtidor luneta trasera Alfa Romeo 147 '00->	190.040	71728628
2	Surtidor luneta trasera Cinquecento, Seicento	190.046	7687086
5	Surtidor lavaparabrisas Dobló'00->, Ducato, Nuova Punto, Panda'03->	190.047	735274992
5	Surtidor lavaparabrisas Multipla	190.048	46821846
5	Surtidor lavaparabrisas Iveco Daily, Fiat Idea, Lancia Ypsilon	190.049	46847980 500327004
2	Surtidor luneta trasera Idea, Panda'03->	190.050	735354534
5	Surtidor lavaparabrisas Nuova Punto 2003->	190.051	735337771
5	Surtidor lavaparabrisas Fiat Punto 99->'03, Croma 2005	190.052	735311599
5	Surtidor lavaparabrisas Stilo (negro)	190.053	735316328
5	Surtidor lavaparabrisas Stilo (gris)	190.054	735322933
2	Surtidor luneta trasera Stilo	190.055	735306873

\* U.E.: Unidad de Envase

New 2009 ●

New 2010 ●

New 2011 ●



# FIAT (ALFA ROMEO / FIAT / LANCIA)

Ø 18



162.404\*



162.894



162.893



162.514\*



162.396



162.394\*



162.395\*



162.536\*



162.400



163.946\*



163.947\*



162.403

\* (imagen 1/2 tamaño real)

U.E.	DESCRIPCION		Ref. Adaptable
-	Tope parachoques posterior Derecha Tipo, Tipo '93	162.394	
-	Tope parachoques posterior Izquierda Tipo, Tipo '93	162.395	
10	Fijac. parachoques Tipo, Tempra	162.396	7590885
5	Tope parachoques Uno, Cromo, Y-10, Thema (ver Seat)	162.400	5981746
10	Tope parachoques Tipo, Tempra, Dedra, Alfa 155 (ver VAG)	162.403	7608126 60805802
-	Tope parachoques Alfa - varios -, Lancia Dedra	162.404	82428097
-	Tope antivibrador parachoques delantero Punto	162.514	7762436 46427367
-	Tope parachoques delantero Cinquecento	162.536	7699248
5	Soporte parachoques delantero Bravo/a, Marea (monta con 161.458)	162.893	7771628
5	Tapón fijac. parachoques delantero y trasero Bravo/a, Marea, Palio	162.894	7788400
1	Soporte derecho parachoques Fiat 500 '07->	163.946	51786776
1	Soporte izquierdo parachoques Fiat 500 '07->	163.947	51786777

# FIAT (ALFA ROMEO / FIAT / LANCIA)



162.273



162.272



162.515



162.516



162.905



162.898



162.899



163.220



162.270



163.495

U.E.	DESCRIPCION	Ref. Adaptable
10	Fijac. varilla capó Alfa R. 145/146, Fiat Bravo/a, Croma '05, Dobló, Ducato, Marea, Tipo, Tempra	162.270 7622907
10	Fijac. varilla capó Fiat Cinquecento, Lancia Y-10, Alfa Romeo 33	162.272 7569853
10	Fijac. varilla capó Fiat Uno, Regata (ver Seat)	162.273 4392447
10	Fijac. varilla capó Fiat Punto -todos-, Lancia Y, Ypsilon	162.515 7739088
10	Fijac. varilla capó Fiat Punto, Punto '99 y '03, Lancia Dedra, Nuevo Delta, Kappa	162.516 7792009 82457328
10	Fijac. varilla capó Fiat Bravo/a, Marea, Punto, Punto '99 y '03, Palio, Croma, Dobló, Ducato, Lancia Y, Nuevo Delta, Dedra	162.898 60607024 504001603 82467481
10	Fijac. varilla capó Fiat Bravo/a, Marea	162.899 46425772
10	Fijac varilla capó Fiat Punto '99, Lancia Y	162.905 7799839
10	Fijac.varilla capó Fiat Panda 2003	163.220 51704854
25	Fijac.insonorizantes capó Alfa Romeo 159, Brera, Spider'06, Fiat Bravo '07, Croma '05, Ducato '06, Grande Punto'05, Linea, Palio, Siena, Strada (ver PSA)	163.495 46804433

# FIAT (ALFA ROMEO / FIAT / LANCIA)



173.080



171.434



162.254



162.252



162.253



162.250



162.251



162.247



162.248



162.533

U.E.	DESCRIPCION	Ref. Adaptable
50	Fijac. faro Fiat Regata (ver Seat)	162.247 4241451
50	Fijac. faro Fiat Regata, Lancia Y-10 (ver Seat)	162.248 7544349
25	Fijac. faro Fiat Tipo, Tempra	162.250 15681000
25	Fijac. faro Fiat Tipo	162.251 14341000
5	Regulador faro Fiat Uno	162.252 5952101
5	Regulador faro Fiat Uno	162.253 5946583
10	Distanciador faro Fiat Uno	162.254 7644689
25	Fijac. faro Fiat Cinquecento, Alfa Romeo - varios - (ver Seat)	162.533 7656214
1	Regulador eléctrico faro Fiat Scudo (ver PSA)	171.434 9632162280
1	Regulador eléctrico faro Iveco Daily (ver Ford, Smart, VAG)	173.080 42536208

# FIAT (ALFA ROMEO / FIAT / LANCIA)



162.351



162.535



162.720

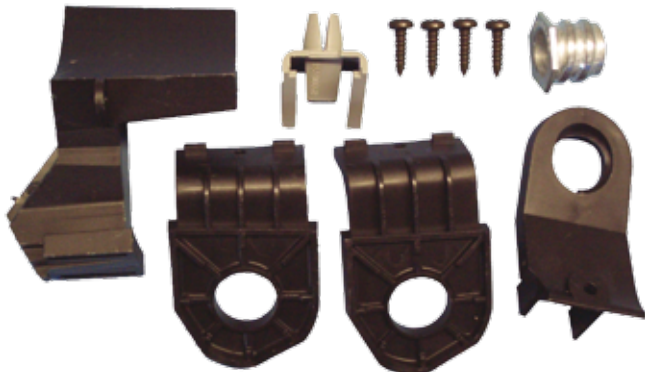

163.118 - Dcho.  
163.119 - Izdo.

\* (imagen 1/2 tamaño real)



163.606 - Dcho.  
163.607 - Izdo.

\* (imagen 1/2 tamaño real)



163.400 - Dcho.  
163.401 - Izdo.

\* (imagen 1/2 tamaño real)



163.402 - Dcho.  
163.403 - Izdo.

\* (imagen 1/2 tamaño real)

U.E.	DESCRIPCION		Ref. Adaptable
10	Fijac. rejilla Alfa Romeo 33, 75, 90	162.351	60528009
10	Fijac. faro Bravo/a, Cinquecento, Dobló, Marea, Seicento	162.535	7703577
10	Fijac. lateral faro Bravo/a, Ducato, Ducato 2002, Marea (ver VAG)	162.720	46440164 46461781
1	Kit reparación faro derecho Punto '99->'03	163.118	
1	Kit reparación faro izquierdo Punto '99->'03	163.119	
1	Kit reparación faro derecho Panda '03->	163.400	
1	Kit reparación faro izquierdo Panda '03->	163.401	
1	Kit reparación faro derecho Fiat Idea, Multipla, Lancia Musa	163.402	
1	Kit reparación faro izquierdo Fiat Idea, Multipla, Lancia Musa	163.403	
1	Kit reparación faro derecho Punto '03->	163.606	
1	Kit reparación faro izquierdo Punto '03->	163.607	

\* U.E.: Unidad de Envase

New 2009 ●

New 2010 ●

New 2011 ●

# FIAT (ALFA ROMEO / FIAT / LANCIA)



163.025



162.305



163.053



162.900



162.901



162.316



184.866 \*

\* (imagen NO a tamaño real)



163.609



162.886



163.492



162.897



162.653

U.E.	DESCRIPCION		Ref. Adaptable
10	Fijac. cristal lateral Croma, Thema	162.305	82415302
10	Fijac. cristal lateral Alfa Romeo 147, Fiat Dobló, Punto, Punto '99, Punto '03, Palio, Multipla, Uno, Lancia Lybra, Y, Y-10	162.316	5994095 7775575
5	Bisagra cristal lateral Uno (ver Seat)	162.653	4378829
10	Fijac. elevallunas Punto	162.886	
10	Fijac. cristal posterior a montante puerta y luneta Alfa Romeo 147, Fiat Bravo/a, Multipla, Lancia Y	162.897	46436251
10	Fijac. cristal lateral Bravo/a, Marea	162.900	7769767
10	Fijac. cristal lateral Ducato, Tipo, Tempra (ver P.S.A.)	162.901	7608099
10	Fijac. cristal lateral Alfa Romeo 156, 159, Fiat Grande Punto '05	163.025	60655007 60664928
10	Fijac. cristal lateral Alfa Romeo 147, Fiat Dobló, Punto 2003	163.053	46776048
10	Fijac. cristal lateral Punto, Nuova Punto, Lancia Y	163.492	4373915 + 46796761
10	Fijac. cristal lateral Ducato'94, Ducato Restyling, Grande Punto '05->	163.609	7798609
-	Guía sujeta cristal Uno (largo 41 cm.)	184.866	4941207



163.500 \*



163.552\* - Dcho.  
163.553\* - Izdo.

\* (imagen 1/2 tamaño real)

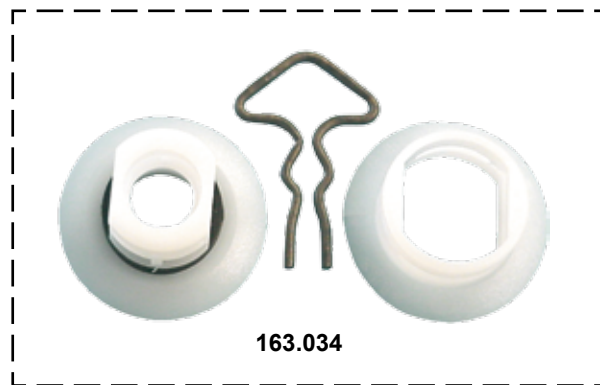

163.034



162.427



162.870



162.871



162.872



162.873

U.E.	DESCRIPCION		Ref. Adaptable
25	Fijac. varilla cerradura Tipo, Tempra, Ducato, Y-10 (ver Seat)	162.427	14578082
25	Fijac. varilla cerr. puerta Ducato, Cinquecento, Cromo, Regata, Uno	162.870	14578180
25	Fijac. varilla cerradura puerta Cromo, Regata, Uno	162.871	5944525
25	Fijac. varilla ceradura puerta Tipo, Tempra, Ducato, A.Romeo - varios -	162.872	7608012
25	Fijac. varilla cerradura puerta A.Romeo 147, 156, Punto '99, Multipla	162.873	82377992
1	Kit fijación elevallunas Scudo, Ulisse'95, Lancia Z (ver PSA)	163.034	9790337080
1	Soporte cristal lateral Marea'99, Panda'03	163.500	46474945
1	Soporte cristal elevallunas derecho Fiat Dobló	163.552	
1	Soporte cristal elevallunas izquierdo Fiat Dobló	163.553	

# FIAT (ALFA ROMEO / FIAT / LANCIA)



162.992



162.993



163.098



163.052



163.612



162.691



162.679



162.680

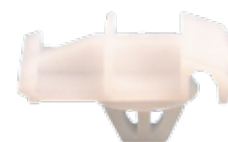

162.964



162.263



162.907



162.475



162.391



162.392



162.944



163.394



163.011

U.E.	DESCRIPCION	Ref.	Adaptable
25	Fijac. moldura techo Fiat Cinquecento, Palio, Siena, Uno, Ducato, Fiorino, Lancia Thema	162.263	5998258 7686500
25	Fijac. moldura bajo puerta Fiat Uno Restyling 1ª serie	162.391	7641970
25	Fijac. moldura bajo puerta Fiat Uno Restyling 2ª serie	162.392	7678808
25	Fijac. junta estanqueidad puerta Fiat Palio, Siena, Strada (ver Renault)	162.475	7078732
25	Fijac. molduras Lancia Dedra, Thema (ver Seat)	162.679	4294167
25	Fijac. moldura Fiat Scudo, Ulisse, Lancia Delta moderno, Zeta (ver PSA)	162.680	7778275
25	Fijac. moldura parachoques Fiat Tipo, Tempra	162.691	7613917
10	Fijac. moldura cristal Fiat Tipo, Tempra	162.907	7617036 4678189
10	Fijac. moldura lateral Fiat Multipla (ver BMW, Opel)	162.944	71717421
10	Fijac. molduras puerta Fiat Ulisse (ver PSA)	162.964	9620669780
50	Fijac. moldura Iveco Daily (ver Opel, Renault)	162.992	500339745
50	Fijac. moldura Iveco Daily (ver Opel, Renault)	162.993	500326896
10	Fijac. molduras Iveco Daily	163.011	500327002
25	Fijac. moldura lateral Fiat Ducato 2001-> (ver PSA)	163.052	71728806
25	Fijac. moldura lateral Fiat Dobló	163.098	71728805
50	Boca fijac. moldura lateral Fiat Multipla, Lancia Y 2000 (ver BMW, VAG)	163.394	
25	Fijac. moldura lateral Iveco Daily '06->	163.612	5041017

# FIAT (ALFA ROMEO / FIAT / LANCIA)



U.E.	DESCRIPCION	Ref. Adaptable
50	Remache fijac. revestimientos interiores Alfa Romeo 145, 146, 155, Fiat Uno, Punto, Croma, Tipo, Tempra, Regata, Ducato, Lancia Dedra, Thema	162.258 5988006
50	Remache fijac. moldura Alfa Romeo 33	162.260 129421
100	Remache fij. moldura exterior Panda '03, fijac. revestimientos interiores Cinquecento, Seicento y otros usos Fiat Uno, Croma, Ducato, Alfa Romeo - varios - (ver PSA)	162.389 5962559
50	Fijac. revestimientos interiores Alfa Romeo 145, 146, 155, 166, Fiat Dobló, Tempra, Lancia Delta, Dedra, Kappa, Thesis (ver Mercedes, PSA, Renault, VAG)	162.424 7556533
50	Remache fijac. panel puerta Fiat 500 '07->, fij. revestimientos interiores Cinquecento, Punto, Bravo/a, Marea, Siena, Tipo, Tempra, Ducato, Alfa Romeo 145, 146, 156, GT, Lancia Dedra, Lybra, Thema	162.517 82421028 504056662
25	Fijac. motor Uno, Punto, Bravo/a, Marea, Palio, Siena, Tipo, Tempra, fij. guarnición puerta Croma	162.519 7569468
100	Remache fijac. parachoques Fiat Panda '03-> (ver PSA)	162.624 51754057
50	Fijac. guardabarros Fiat Ulysse, Lancia Phedra (ver PSA)	162.979 9621385880
50	Remache fijac. rejilla parabrisas Fiat 500 '07, Croma '05-> (ver Renault)	163.140 51761163
50	Remache fijac. revestimientos interiores Fiat Scudo, Ulysse '01, Lancia Phedra (negra) (ver PSA)	163.299 500358569
50	Remache fijac. revestimientos interiores Fiat Scudo, Ulysse '01, Lancia Phedra (gris) (ver PSA)	163.303 9621837480
10	Fijac. pasoruada, parachoque y bajos carroceria Fiat Sedici '06 (ver Honda, Suzuki, Toyota)	163.476 71741883
25	Remache fijac. protector motor y tapizados Croma '05->	163.610 51756677
25	Fijac. talonera puerta Fiat Sedici '06-> (ver Suzuki)	163.814 71741894
25	Fijac. parrilla radiador Ducato '06-> (ver PSA)	163.963 1357450080
10	Fijac. pasoruada Alfa Romeo Mito, Fiat Grande Punto	163.973 51780607



# FIAT (ALFA ROMEO / FIAT / LANCIA)



162.229



162.598



162.227



163.093



162.699



162.714



162.232



163.094



7 x 10

162.895



7 x 13

162.896



8 x 8

163.499



8 x 10

163.808

U.E.	DESCRIPCION	Ref. Adaptable
50	Fijac. panel puerta Alfa Romeo - varios -, Fiat Dobló, Marea, Uno, Lancia Y-10	162.227 14188282 92511089 46306526
100	Fijac. panel puerta Uno, Regata, Alfa 33 (ver PSA, Renault)	162.229 14188380
50	Fijac. panel puerta Y-10	162.232 7570122
50	Fijac. panel puerta Regata (ver Seat)	162.598 4399987
10	Fijac. panel puerta Bravo/a, Marea	162.699 7769778
50	Fijac. panel puerta Tipo, Tempra, Uno, Alfa 33, Lancia Y-10, Delta	162.714 14191280 82377183
25	Fijac. toma aire Fiat Bravo/a, Marea, Multipla, Lancia Lybra, fijac. tapiz. interiores traseros Alfa Romeo 159	162.895 46459200
25	Fijac. revestimientos interiores Fiat Bravo/a, junta puerta Marea	162.896 5896153 46524246
50	Fijac. spoiler bajo puerta Fiat Punto '99 y '03, Stilo '01, fij. panel puerta Fiat Croma, Lancia Thema	163.093 14186880 46786189
25	Fijac. tapizados interiores Alfa Romeo 156, Fiat Punto'99-'03, Lancia Thesis	163.094 60660554
25	Fijac. tapizados portón trasero Fiat Croma '05, Panda '03	163.499 51708640
25	Fijac. rejilla parabrisas "torpedo" Alfa Romeo 147 y GT (Eurocode 2037ASCHB)	163.808 60594191

# FIAT (ALFA ROMEO / FIAT / LANCIA)



U.E.	DESCRIPCION	Ref. Adaptable
50	Fijac. panel puerta Fiat Uno	162.228 7538675
100	Fijac. panel puerta Fiat Uno 1ª serie, Regata, Ducato (ver Seat)	162.378 14187880
50	Fijac. panel puerta Alfa Romeo 145/146, Fiat Ducato '94, Uno, Y (ver PSA)	162.379 14191180
50	Fijac. revestimientos interiores Tipo, Tempra	162.398 7658893
50	Fijac. panel puerta y revestimientos interiores Fiat Multipla, Panda '03, Punto '93, Seicento, Lancia Kappa, Lybra, Y	162.399 46410400 60600860
50	Fijac. panel puerta Alfa Romeo 145, 146, 156, 166, GT, Fiat Bravo/a, Cromo, Dobló, Marea, Panda'03, Punto -todos-, Tipo/Tempra, Lancia Nuevo Delta, Y, Ypsilon	162.510 7733801
50	Fijac. panel puerta Fiat Tipo, Tempra 1ª serie, Cinquecento	162.530 7603823 + 7603825
50	Fijac. panel puerta Fiat Punto'99 y '03, fijac. panel maletero Fiat Stilo '01 (monta con 162.977)	162.976 46776091
25	Fijac. panel puerta Fiat Ulisse (ver PSA, Renault)	163.083
25	Fijac. revestimientos interiores Alfa Romeo 147, Fiat Idea	163.221 46829200
25	Fijac. panel puerta y revestimientos interiores Fiat Grande Punto '05->	163.397
25	Fijac. parachoques Fiat Grande Punto '05->, moldura lateral Fiat Panda '03->	163.399 46835626 71738386
50	Fijac. panel puerta Fiat Scudo III (ver P.S.A.)	163.453
25	Fijac. rejilla lavaparabrisas («torpedo») Grande Punto '05, fijac. tapizados portón trasero Cromo'05	163.608 71747674
50	Fijac. tapizados interiores Fiat Dobló	163.965 51831913
50	Fijac. tapizados interiores Fiat Grande Punto	163.967 71748293
25	Fijac. panel puerta y tapizados Fiat Qubo	163.968 735500166

\* U.E.: Unidad de Envase

New 2009 ●

New 2010 ●

New 2011 ●

# FIAT (ALFA ROMEO / FIAT / LANCIA)



U.E.	DESCRIPCION	Ref.	Adaptable
50	Botón fijac. revestimientos interiores Alfa Romeo 33/164	162.354	60503610
100	Fijac. tapizados Fiat Punto '99->'03, Palio, Siena, Uno, Fiorino, Lancia Y-10, Thema (ver Seat)	162.493	14592587
50	Botón fijac. antivibrador parachoques delantero Fiat Punto y fijac. tapiz. interiores Alfa Romeo 156, Fiat Ducato, Palio, Siena (ver PSA)	162.512	1301788650 1301788800 1301019650
100	Botón fijac. revestimientos interiores Cinquecento, fijac. aislante capó Tipo, Tempra (ver PSA)	162.660	82412036
50	Botón fijac. aislante capó Fiat Cinquecento, Uno, Punto, Bravo/a, Marea, Cromo, Lancia Y-10, y fijac. panel puerta Alfa Romeo Brera	162.706	5961759 7560860
50	Botón fijac. revestimiento capó Alfa Romeo 155, Fiat Bravo/a, Uno, Tipo, Lancia Dedra, Delta	162.815	60506575 5757139
50	Fijac. aislante capó Alfa 147, 156, 159, Brera, Fiat Bravo/a, Dobló, Marea, Punto'99 y '03, Palio, Lancia Kappa, Lybra, y fijac. revestimientos portón Punto'99	162.908	735266957
25	Fijac. revestimientos interiores Iveco Daily, Lancia Lybra	163.009	504010315
25	Fijac. pasoruada Fiat Stilo	163.099	46842097
25	Fijac.pasoruada y revestimientos interiores Alfa Romeo 159, Brera, Fiat Bravo/a, Idea, Punto'99, Punto'03, Stilo, Lancia Kappa, Lybra	163.216	14565987
25	Fijación panel puerta Fiat Dobló	163.217	735366395
50	Fijac. tapizados Alfa Romeo 145, 146, 147, 155, 156, 166, Brera, GTV, Fiat Bravo/a, Ducato '02, Marea, Tipo, Tempra, Lancia - varios -	163.494	14593487
50	Fijación tapizados interiores Fiat Dobló	163.497	735293986
50	Fijación pasoruada Grande Punto, fij. toma de aire Bravo '07->, fij. tapizados interiores Punto	163.945	718115080
25	Fijación tapizados interiores Alfa Romeo Mito, Fiat Dobló, Qubo	163.964	735493588
25	Fij. tapizados y protecciones interiores Alfa R. Mito, Fiat Idea, Punto '99 y '03, Lancia Musa, Ypsilon	163.969	7352905437
25	Fijac. parachoques y tapizados interiores Fiat Ducato '06, Palio, Siena, Lancia Kappa	163.971	14589887
25	Fijac. tapizados interiores Fiat Dobló '00->'09, Ducato '06	163.972	735430175

# FIAT (ALFA ROMEO / FIAT / LANCIA)



163.496



162.911



162.880



162.369



162.909

Tornillo Ø 5



163.830

Tornillo Ø 5



163.970

Tornillo Ø 6



163.493

8 x 8  
Tornillo Ø 5



162.368

10 x 10  
Tornillo Ø 3,9



162.891

7 x 12  
Tornillo Ø 4,2



162.902

7 x 14  
Tornillo Ø 3,9



162.892

7 x 13  
Tornillo Ø 4,2



162.523

7 x 14  
Tornillo Ø 3,9



163.222

7 x 15  
Tornillo Ø 4,2



162.888

U.E.	DESCRIPCION	Ref. Adaptable
25	Taco fijac. varios usos Uno, Tipo, Tempra, Punto, Y-10, Croma,	162.368 14216080 14216087
50	Fijac. guardabarros, guarnición puerta y tapizados Alfa Romeo 145, 146, 147, 155, 156, fijac. guarnición puerta y tapizados Fiat Bravo/a, Croma, Dobló, Ducato, Marea, Multipla, Palio, Punto, Stilo, Tipo, Tempra, Uno, Lancia Y	162.369 76778650
50	Taco fijac. revestimientos interiores Fiat Cinquecento, Uno, Punto, Bravo/a, Marea, Tipo, Tempra, Alfa 145, 146 y 156 (ver PSA, Renault)	162.523 7543023 7677856
50	Fijac. gomas puerta y capó Ducato (ver PSA)	162.880 9605146380
50	Taco revestim. interiores Bravo/a, Dobló, Punto, Tipo, Alfa (ver VAG)	162.888 7622606
25	Fijac. rejilla toma aire a capó Punto, Punto '99 y '03 y parabrisas Ducato	162.891 46403322
50	Taco fijac. toma aire capó y revestim. interiores Alfa Romeo 147, 156, 159, Bravo/a, Dobló, Marea, Punto -todos-, Palio, Multipla (ver PSA)	162.892 7754387
50	Taco fijac. revestim. interiores y otros usos Fiat Bravo/a, Croma, Dobló, Marea, Ducato, Stilo, Tipo, Tempra, Uno, Lancia Dedra, Thema (ver PSA)	162.902 46478225 82422490
50	Fijac. radiador Alfa 156, guarnición capó Punto, Bravo/a, Marea, Punto	162.909 7768047
25	Tapón para toma de aire exterior Alfa Romeo 147, Bravo/a, Marea	162.911 46424310
25	Taco fijac. revestimientos inter. Iveco Daily (ver Dacia, PSA, Opel, Renault)	163.222 500389689
25	Fijac. pasoruada Ducato - todos -, y fijac. tapizados interiores y protecciones Fiat Bravo/a, Fiorino, Panda '03, Talento, Uno (ver PSA)	163.493 4343799
25	Fijac. tapizados interiores Fiat Cinquecento, Croma, Dobló, Multipla, Palio, Punt, Seicento, Siena, Strada, Tempra, Tipo, Lancia Dedra, Delta, Nuevo Delta	163.496 7689821 82406852
50	Fijac. pasoruada Fiat 500 '07-> (ver Ford)	163.830 ● 50504884
25	Fijac. pasoruada Alfa Romeo 159, Brera, Mito, Fiat Croma '05, Dobló '00->'09, Ducato '06, Grande Punto, Linea, Punto EVO, Qubo	163.970 ● 60502080

# FIAT (ALFA ROMEO / FIAT / LANCIA)

6 x 6  
Tornillo Ø 3



**162.326**

6 x 7  
Tornillo Ø 3,5



**162.245**

7 x 7  
Tornillo Ø 3



**162.238**

7 x 7  
Tornillo Ø 4,2



**162.244**

7 x 7  
Tornillo Ø 4,2



**163.611**

7 x 7  
Tornillo Ø 4,8



**163.498**

8 x 8  
Tornillo Ø 4,8



**162.966**

8 x 8  
Tornillo Ø 4,8



**162.887**

8 x 8  
Tornillo Ø 4,8



**163.218**

Ø 8,5  
Tornillo Ø 3,5



**162.264**

10 x 10  
Tornillo Ø 4,2



**162.545**

U.E.	DESCRIPCION	Ref. Adaptable
100	Taco fijac. revestimientos interiores Cinquecento, Uno, Bravo/a, Marea, Cromo, Tipo, Tempra, Regata, Ducato, Y-10, varios usos Punto, Alfa R. - varios - (ver Ford, Mercedes, Seat, Renault)	<b>162.238</b> 14201980 17894580
100	Taco fijac. - varios usos - Fiat Punto, Bravo/a, Marea, Tipo, Tempra, Ducato, Lancia Y-10, Alfa R. (ver PSA, VAG)	<b>162.244</b> 83468353 14115960
25	Fijac. pilotos posteriores Fiat Tipo, Tempra (sin junta)	<b>162.245</b>
50	Boca fijación siglas Fiat Cinquecento, Uno, Regata, Duna, Fiorino	<b>162.264</b> 4358789
100	Taco fijac. revestimientos interiores Fiat Cinquecento, Seicento, Punto, Uno, Tipo, Tempra, Regata, Ducato, Alfa Romeo - varios - (ver Seat)	<b>162.326</b> 14215480 82468243
50	Fijac. rejilla Fiat Uno, paneles Fiat Tipo, Tempra, varios usos Alfa Romeo	<b>162.545</b> 14203680
10	Boca panel puerta y revestimientos interiores Alfa Romeo 147, 156, 159, 166, Fiat Bravo/a, Dobló, Ducato, Marea, Multipla, Punto -todos-, Stilo, Lancia Kappa, Lybra, Y, Ypsilon (ver PSA)	<b>162.887</b> 46408953 46748771
10	Fijac. panel puerta y revest. interiores Fiat Punto '99 y '03, Lancia Ypsilon	<b>162.966</b> 46558337
10	Boca fijac. panel puerta Fiat Idea	<b>163.218</b> 51723187
50	Taco fijac. pasoruada Fiat Punto '03, Lancia Musa	<b>163.498</b> 46777315
25	Taco fijac. matrícula Iveco Daily	<b>163.611</b> 500380712

# FIAT (ALFA ROMEO / FIAT / LANCIA)

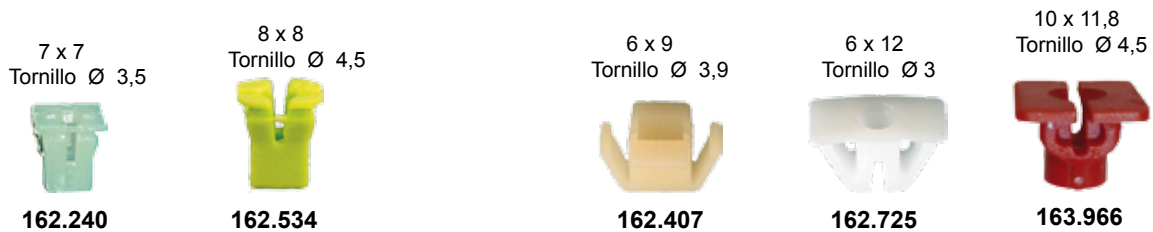
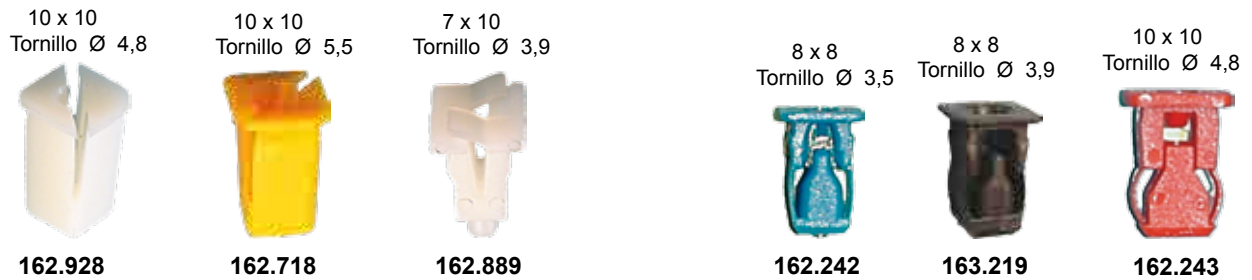

U.E.	DESCRIPCION	Ref. Adaptable
100	Taco fijac. rejilla Fiat Uno, Alfa 145/146, matrícula Fiat Dobló (ver Seat)	<b>162.240</b> 14211580
25	Taco fijac. revestimientos interiores Fiat Punto, Croma (ver Seat)	<b>162.242</b> 14202782
25	Taco fijac. revestim. interiores Fiat Ducato, Uno, Lancia Y-10, Y (ver Seat)	<b>162.243</b> 14202985
25	Fijac. toma de aire Fiat Marea, Tipo, Tempra, fijac. pasoruada Fiat Bravo/a	<b>162.407</b> 7587776
10	Boca panel puerta Bravo/a, Marea, Tipo, Tempra, Alfa 145, 146 y 155	<b>162.408</b> 7739802
10	Boca panel puerta y revestimientos interiores Fiat Croma, Multipla, Palio, Punto -todos-, Seicento, Stilo, Strada, Lancia Kappa, Lybra, Y, Ypsilon	<b>162.511</b> 7745194
10	Boca panel puerta Fiat Cinquecento, Tipo, Tempra, Ducato, Alfa Romeo 164	<b>162.531</b> 7603825 7636064
50	Taco fijac. revestimientos interiores y pasoruada Fiat Bravo/a, Cinquecento, Croma, Marea, Regata, Seicento, Uno, Lancia Y-10, Y (ver Seat)	<b>162.534</b> 14202383
25	Fijac. pasoruada Fiat Punto, revestim. interiores Fiat Tipo, Tempra (ver Ford)	<b>162.718</b> 14222581
25	Fijac. escudo frontal Alfa Romeo 75, 90, 145, 146, 164	<b>162.725</b> 60509945
10	Fijac. toma aire Fiat Punto, Punto '99, Lancia Y	<b>162.889</b> 7734462
25	Taco fijac. pasoruadas Fiat, Lancia - varios - (ver Ford)	<b>162.928</b> 14222380 83468453
10	Boca fij. panel puerta y tapizados Fiat Punto '99 y '03 (monta con 162.976)	<b>162.977</b> 46738532
25	Taco fijac. revestimientos interiores Fiat Bravo/a, Coupe, Marea, Punto '03, fijac. panel puerta Palio, Dedra, Nuevo Delta	<b>163.219</b> 14203587
25	Fijac. panel puerta y revestimientos interiores Fiat Grande Punto '05->	<b>163.398</b> 51779614
25	Fijac. revestimientos interiores y tapizados Alfa Romeo 147, 156, GT, Fiat 500 '07, Grande Punto, Punto EVO, Stilo, Lancia Delta	<b>163.966</b> 51721582

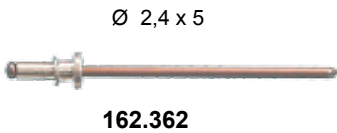

U.E.	DESCRIPCION	Ref. Adaptable
25	Fijac. protectores cárter y protectores térmicos Escort, Fiesta, Focus, Mondeo, Puma, Sierra, Transit, Transit Connect (ver VAG)	<b>161.461</b> 6 715 468 W700641S301
10	Fijac. protectores cárter y protectores térmicos Ford modernos	<b>161.462</b>
50	Tornillo Ø 4,8 x 15 (aro Ø 15), varios usos (ver BMW, Mercedes, Opel, PSA, VAG)	<b>161.473</b>
50	Tornillo Ø 4,8 x 18 (aro Ø 15), varios usos (ver BMW, Mercedes, Opel, PSA, VAG)	<b>161.474</b>
25	Fijac. guarnecidos puerta (junta cristal) Ford -varios modelos -	<b>161.479</b>
50	Tornillo Ø 5,5 x 19 (aro Ø 22), sujeción guardabarros (ver BMW, Mercedes, Opel, VAG)	<b>161.742</b>
50	Tornillo Ø 6,3 x 19 (aro Ø 22), sujeción guardabarros (ver BMW, Mercedes, Opel, VAG)	<b>161.743</b>
50	Remache Ø 2,4 x 5, varias aplicaciones (ver Fiat, Opel, PSA, Renault V.A.G.)	<b>162.362</b> 6 028 434 E642280S
50	Remache fijac. pasoruada Fiesta '89	<b>162.384</b> 1 647 309
50	Tornillo Ø 5,5 x 19 (aro Ø 18), sujeción guardabarros (ver Opel, V.A.G.)	<b>162.555</b> 2 026 706
50	Tornillo Ø 6,3 x 19 (aro Ø 18), sujeción guardabarros (ver BMW, Mercedes, Opel, VAG)	<b>162.556</b> 1 470 997 1 473 084 2 022 203 6 077 150
10	Tornillo fij. intermitente delant. a parachoques Focus '98->'05 (monta con 162.963)	<b>164.685</b> 1 077 106 W706160S309

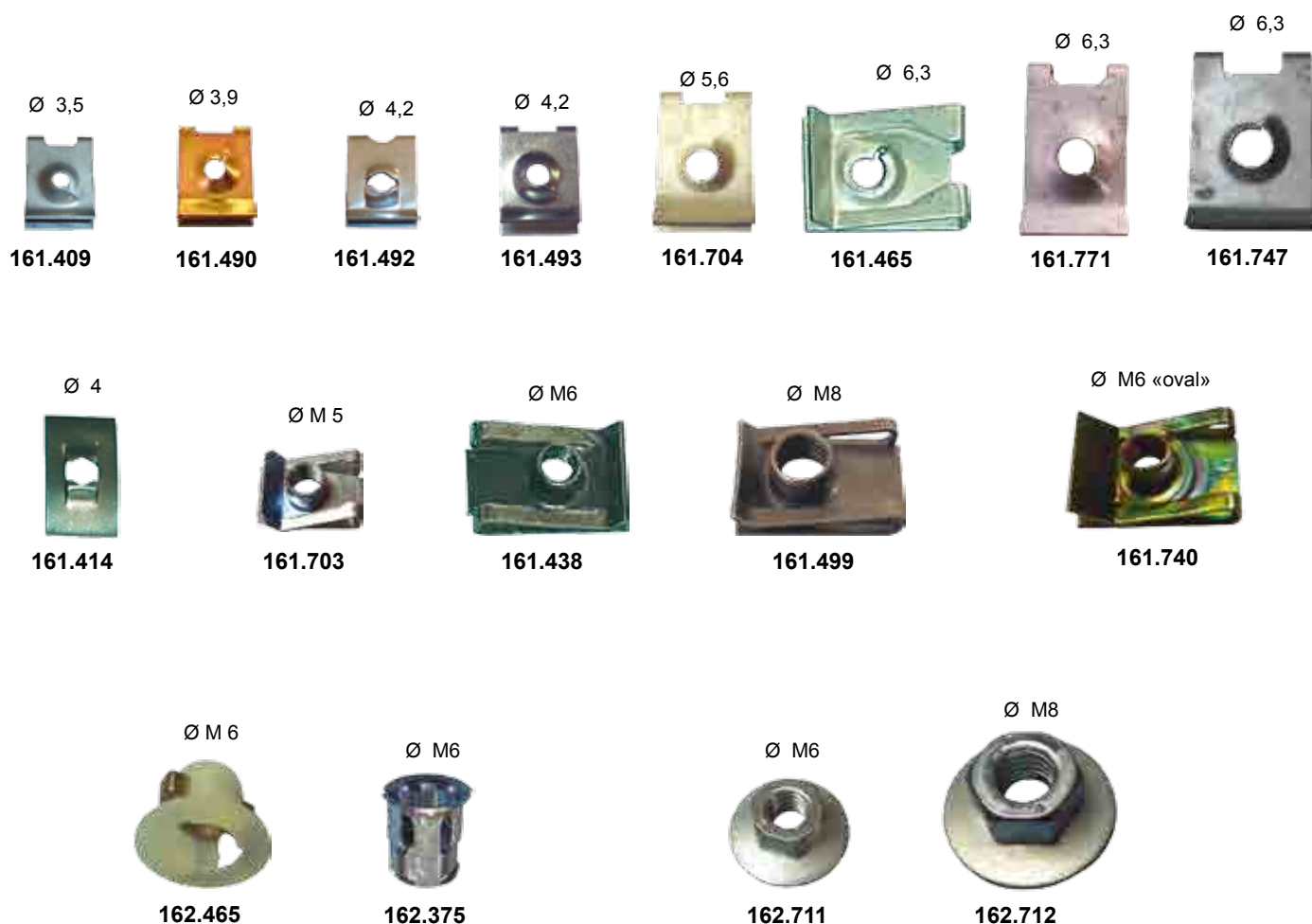

U.E.	DESCRIPCION		Ref. Adaptable
50	Clip fijac. varios usos - varios -	161.409	1 474 663 E623300S71
50	Clip fijac. varios usos - varios - (ver Mercedes)	161.414	1 503 837
50	Clip fijac. varios usos - varios - (ver Renault)	161.438	
50	Clip fijac. frontal Fiesta, Escort (ver Opel, VAG)	161.465	
50	Clip fijac. varios usos - varios - (ver BMW)	161.490	
50	Clip fijac. varios usos - varios - (ver Ford)	161.492	1 716 235
50	Clip fijac. varios usos - varios - (ver BMW, Mercedes)	161.493	
50	Clip fijac. talonera puerta P-306, P-605 (ver PSA, Renault)	161.499	6 103 426 E8224125S81
50	Clip fijac. varios usos - varios - (ver Mercedes, Renault)	161.703	
50	Clip fijac. varios usos - varios - (ver BMW, Opel)	161.704	
10	Clip (especial «ovalado») fijac. varios usos - varios -	161.740	6 740 771
50	Clip fijac. revestimientos puerta Ford - varios modelos - (ver Mercedes)	161.747	6 314 544
50	Clip fijac. aleta delantera Ford C-Max, Focus '05->, Mondeo '96->'07	161.771	1 084 756 W706066S301
25	Tuerca especial redonda varios usos (Ø 6) (ver PSA, Renault)	162.375	
50	Fijac. parachoques - varios modelos - (ver Fiat, PSA, Renault)	162.465	
25	Tuerca con aro móvil, varios usos (ver Opel, PSA, Renault, VAG)	162.711	
25	Tuerca con aro móvil, varios usos (ver Opel, PSA, Renault, VAG)	162.712	





190.365\*



190.366\*



190.367\*



190.368\*



190.359\*



190.382\*

\* (imagen 1/2 tamaño real)



190.007



190.008



190.069



190.070



190.071

U.E.	DESCRIPCION		Ref. Adaptable
5	Surtidor lavaparabrisas Fiesta '89->	190.007	6 163 974 89FG-17666-AA
5	Surtidor lavaparabrisas Fiesta '96->'02	190.008	96 FG 17666 AA
5	Surtidor lavaparabrisas Fiesta '02->'08, Fusion	190.069	1 442 176 2N11-17666-AD
5	Surtidor lavaparabrisas Focus '05->	190.070	1 404 820 3M51-17666-AD
5	Surtidor lavaparabrisas Ka '99->'08, Street Ka	190.071	1 077 453 98KG-17666-AA
1	Bomba lavaparabrisas C-Max'03->'11, Fiesta '08->, Focus '05->, Galaxy '06->, S-Max '06->, Kuga, Mondeo '00 y '07-> (ver Volvo)	190.359	1 355 124 1 514 079 1S7117K624FE
1	Bomba lavaparabrisas Fiesta '76 / '89, Granada, Sierra, Transit '85->'94 (ver Daewoo, Honda, Hyundai, Mitsubishi, Suzuki, Toyota)	190.365	6 140 949 83BB17K624AA
1	Bomba lavaparabrisas Escort, Fiesta ->'96, Focus '98->'05, Mondeo, Transit	190.366	7 003 177 93BB17K624AA
1	Bomba lavaparabrisas Escort, Fiesta ->'08, Focus '98->'05, Ka, Mondeo, Puma, Transit	190.367	7 003 178 93BB17K624BA
1	Bomba lavaparabrisas Galaxy '94->'00 (ver Opel, VAG)	190.368	7 222 079 95VW17K624AA
1	Bomba lavafaros Galaxy '00->'06 (ver BMW, VAG)	190.382	1 209 387 2M2113K082AA

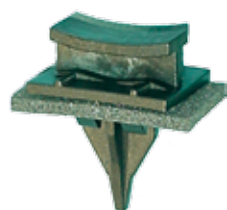

163.021



163.022



163.018



163.915

7 x 7



162.812



163.023



163.613



163.133



163.641

U.E.	DESCRIPCION		Ref. Adaptable
50	Remache rejilla parabrisas ("torpedo") Fiesta, Escort, Sierra, Mondeo, Transit II ('86->'97) (Eurocode 3731ASCSB / 3539ASCHS) (ver VAG)	162.812	6 114 021 E864164S
10	Fijac. rejilla parabrisas ("torpedo") Focus '98->'04 (Eurocode 3556ASCHB)	163.018	1 106 903 W703475S300
10	Fijac. moldura parabrisas Transit IV ('2000->) (Eurocode 3739ASCV1)	163.021	4 069 906 4 494 055 YC15B03180AB
10	Fijac. moldura parabrisas Transit IV ('2000->) (Eurocode 3739ASCV)	163.022	4 069 907 4 494 056 YC15B03180BB
25	Tapón parrilla lavaparabr. Escort '97, Mondeo '93 y '97, Transit (Eurocode 3546ASSH/ASCHB1B)	163.023	6 781 550 W701223S300
10	Base soporte parabrisas Fiesta '02->, Galaxy '94->'98, Ka, Mondeo '93->'96 (Eurocode 3554ASCH)	163.133	1 022 510 6 974 009 93BBF030A12AE
10	Fijac. rejilla lavaparabrisas ("torpedo") Mondeo I, Orion. Scorpio (Eurocode 3546ASCHB)	163.613	6 781 549 W701221S300
10	Base soporte parabrisas Focus '98->'04	163.641	3 680 267 98AB030A12AB
10	Fijac. rejilla parabrisas ("torpedo") Galaxy '94->'06 (Eurocode 3550ASCVS)	163.915	1 023 253 95VWA03836CA



163.766



163.508\* - Dcho./Izdo.



162.282



163.180



162.266



162.618



162.409



163.505



162.257



163.440



162.298 - Dcha.  
162.299 - Izda.



173.080\*

\* (imagen 1/2 tamaño real)

U.E.	DESCRIPCION	Ref. Adaptable
25	Fijac. rejilla frontal Fiesta (ver VAG)	162.257 1 500 238 E826110S
25	Fijac. anagramas modelos (ver Opel)	162.266
20	Base regulador faro Fiesta '89	162.282 6 184 715 89FG13B128CA
5	Regulador faro Derecho Fiesta '89	162.298 6 186 660 89FG13K040EA
5	Regulador faro Izquierdo Fiesta '89	162.299 6 186 659 89FG13K040DA
25	Taco fijac. faro trasero Escort '95	162.409
25	Fijac. letreros Fiesta (ver PSA)	162.618
10	Taco fijacion faro Focus '98-'04, Fiesta '01-'08, Sierra	163.180 6 156 396 87BG13N129AA
25	Fijac. insonorizantes capó y tapizados interiores Focus '05, Galaxy '06, Kuga '08, Mondeo '07, S-Max '06	163.440 1 251 866 W709688S300
25	Taco fijac. faro antiniebla a parrilla delantera C-Max, Fiesta '08, Focus '05, Kuga '08	163.505 6 659 902 W700895S300
5	Soporte faro delantero (dcho/Izdo) Focus'05->	163.508 1 324 270 4M5113N060AA
10	Fijac. pilotos traseros C-Max '03->'11, Fiesta '02 y '08->, Focus '98 y '05->, Kuga, Mondeo '00->'07,	163.766 ● 1 128 772 W707612S300
1	Regulador eléctrico faro Galaxy '94->'06 (ver Fiat, Smart, VAG)	173.080 ● 1 041 664 95VW13K193CA



163.566\* - Dcho.  
163.567\* - Izdo.

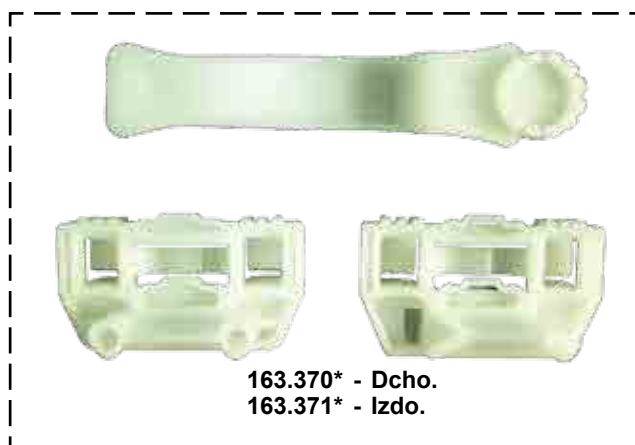

163.370\* - Dcho.  
163.371\* - Izdo.



163.570\* - Dcho.  
163.571\* - Izdo.



163.572\* - Dcho.  
163.573\* - Izdo.



163.568\* - Dcho.  
163.569\* - Izdo.



163.564\* - Dcho.  
163.565\* - Izdo.

\* (imagen 1/2 tamaño real)

U.E.	DESCRIPCION	Ref. Adaptable
1	Kit reparación elevalunas Focus ('98->'05), puerta derecha	163.370
1	Kit reparación elevalunas Focus ('98->'05), puerta izquierda	163.371
1	Soporte cristal elevalunas Galaxy, puerta derecha (ver VAG)	163.564
1	Soporte cristal elevalunas Galaxy, puerta izquierda (ver VAG)	163.565
1	Soporte cristal elevalunas trasero derecho Focus ('98->'05)	163.566
1	Soporte cristal elevalunas trasero izquierdo Focus ('98->'05)	163.567
1	Soporte cristal elevalunas derecho Ka, Mondeo	163.568
1	Soporte cristal elevalunas izquierdo Ka, Mondeo	163.569
1	Soporte cristal elevalunas trasero derecho Fiesta '96->	163.570
1	Soporte cristal elevalunas trasero izquierdo Fiesta '96->	163.571
1	Soporte cristal elevalunas delantero derecho Fiesta '02->, Fusion	163.572
1	Soporte cristal elevalunas delantero izquierdo Fiesta '02->, Fusion	163.573



161.420



162.548



162.230



162.953



162.950



163.685



163.754



163.741



163.960



162.385



163.230



163.683



162.844



163.686



162.951

U.E.	DESCRIPCION	Ref. Adaptable
50	Fijac. panel puerta Fiesta, Escort (ver BMW, Mini)	161.420 6 117 693
25	Fijac. panel puerta y revestimientos interiores Fiesta, Galaxi (ver VAG)	162.230
25	Fijac. tapicería Fiesta '89	162.385 6 142 786 E864181S
50	Fijac. tapicería (color verde)	162.548 1 591 426
50	Botón + boca fijación revestimientos interiores Galaxi (ver Opel, VAG)	162.844 1 065 204 95VW257K42AA
25	Fijac. revestimientos parachoques Ka	162.950 1 038 008 W704309S300
25	Boca fijac. revestimientos parachoques Ka (monta en 162.950)	162.951 1 031 769 W704411S300
50	Fijac. revestimientos interiores Fiesta '89 y '96 (ver Mercedes)	162.953 E865220S
25	Fijac. tapizados Galaxi (ver VAG)	163.230
25	Fij. revestimientos interiores C-Max, Fiesta '96-'01 y '02-', Focus, Kuga, Mondeo '93-'07 y '07-', Transit '94-'06 y '06-', Transit Connect	163.683 1 020 193 6 877 869 W704258S300
25	Fijac. tapizados portón trasero Focus '04, C-Max '03-'07	163.685 1 360 385 3M51-28774-BB
25	Fijac. tapizados portón trasero Focus '04	163.686 1 424 916 W711022S300
25	Fijac. tapizados portón trasero Transit '00-'06 y '06-', fij. tapizados puerta Transit Connect '02	163.741 4 097 718 W705364S300
25	Fijac. panel puerta Fiesta '08-', Kuga, fij. revestimientos interiores Fiesta '08, Mondeo '07, S-Max (ver Mini)	163.754 1 387 954 W712417S300
25	Fijac. revestimientos interiores puerta Fiesta '02-'08	163.960 1 144 718 W708355S300



162.810



163.013



163.090



162.847



162.372



163.594



163.681



163.682



162.405



162.235



162.231



162.973



163.900



163.721



163.441



163.914

U.E.	DESCRIPCION	Ref. Adaptable
50	Fijac. panel puerta Fiesta y Sierra	162.231 6 099 812 E865063S
50	Fijac. panel puerta - varios modelos - (ver BMW, VAG)	162.235
100	Fijac. panel puerta Transit '00 y '06 (ver PSA y Renault)	162.372 4 046 124 W705254S300
50	Fijac. panel puerta Fiesta, Escort (ver Seat)	162.405 7 723 510
50	Fijac. panel puerta Fiesta '89-'96, Escort '95, Ka '97	162.810 6 176 723 E865682S
50	Fijac. tapizados puerta Focus, Galaxi, Explorer, Windstar (Eurocode 3550SSCVFDX) (ver VAG)	162.847 1 008 068 3 865 953 95VWA310A46DB
50	Fijac. panel puerta Focus '98	162.973 1 070 107
25	Fijac. panel puerta Ka, Focus, Fiesta, '96, Puma	163.013 1 020 732 W704402
25	Fijac. panel puerta Fiesta '02, Fusion	163.090 1 044 806 W704165S300
10	Fijac. panel puerta Focus '04, C-Max '03->'10	163.441 1 257 376 W709004S300
25	Fijac. panel puerta C-Max '11-> (ver PSA)	163.594 4 860 409 W713489S300
50	Fijac. panel puerta Focus '04, C-Max '03->'07, fijac. portón trasero Fiesta '02	163.681 1 214 485 W709011S300
50	Fijac. panel puerta Fiesta '02->'08 y '08->, C-Max '03->'07	163.682 1 208 973 1 552 662 W709010S300
25	Fijac. tapizados puerta Mondeo '07, fijac. parachoques Ka '96->, fij. tapizados interiores Fiesta '02, Fusion '02	163.721 1 029 182 W704453S300
10	Fijac. junta panel puerta trasera Focus '98->'04	163.900 1 097 787 W706236S300
10	Fijac. aletas Ka '96->, Street Ka	163.914 1 041 646 97KB17N800AE



U.E.	DESCRIPCION	Ref. Adaptable
25	Fijac. tapizados interiores Escort '91-> y '97-> (color gris)	<b>162.381</b> E866061SSYNB
50	Fijac. revestimientos interiores Fiesta, Escort, Transit (color gris)	<b>162.382</b> 1 018 433 W704218SSMJCP
50	Fijac. revestimientos interiores Fiesta, Escort (color negro)	<b>162.383</b> 6 725 950 E866202S-SYNB3
50	Botón fijac. aislamiento capó y tapizados interiores Connect, Cougar, Fiesta '01 y '08->, Focus '98, Escort, Ka, Mondeo '94-'07, Puma, Transit '00 y '06->, Transit Connect '02	<b>162.658</b> 6 678 518 W700671S300
50	Botón fijac. revestimientos e insonorizante capó Focus'98, Mondeo (ver BMW, Opel, VAG)	<b>162.782</b> 6 998 849 1 079 129 W702846S300
25	Fijac. tapizados interiores Escort '95	<b>162.878</b> 6 866 257
50	Fijac. revestimientos interiores Fiesta, Escort, Transit '94-'00 (color gris claro) (ver Nissan)	<b>162.910</b> 1 018 434 W704218SSYEDQ
25	Fijac. revestimientos interiores Fiesta '89 y '96	<b>162.954</b> 1 047 847 W704294S300
50	Fijac. aislante capó y revestimientos interiores Ka (ver Volvo)	<b>162.959</b> 6 786 759 W702122S300
25	Fijac. tapizados interiores Escort '91-> y '97-> (color negro)	<b>162.960</b> E866061SSYNB
50	Fijac. tapizados interiores e insonorizante capó Transit '06 (ver VAG)	<b>163.129</b> 1 370 597 W704128SSYYJ6
25	Fijación tapizados interiores C-Max '11, Focus '04, Galaxy, Mondeo '93->'07 y '07->, S-Max '06, Transit '06, fijac. deflector delantero Fiesta '02 y '08->, Fusion	<b>163.722</b> ● 6 717 617 W700673S300
25	Fij. tapiz. interiores Escort, Fiesta ->'01 y '08, Granada, Sierra, fij. aislador techo Transit Connect '02 fijac. deflector aire Mondeo '00, fij. insonorizante Focus '98->'04 y '05->, C-Max '03->'11, Kuga '08	<b>163.742</b> ● 6 560 532 W700185S300
25	Fijac. parachoques delantero Fiesta '08->, fijac. tapizados piso Transit '06->	<b>163.744</b> ● 4 052 617 W706358S300
10	Fijac. soporte parachoques trasero Galaxy '06->, S-Max '06	<b>163.878</b> ● 4 740 548 W709571S300



U.E.	DESCRIPCION	Ref. Adaptable
100	Remache varios usos Ford (ver Mercedes, Opel, PSA, VAG)	162.373 1 104 880
25	Remache pasoruada Fiesta, Escort	162.425
50	Fijac. pasoruada Galaxi '94-'06 (ver VAG)	162.632 7 200 671
50	Remache rejilla parabrisas ("torpedo") Fiesta, Escort, Sierra, Mondeo, Transit II ('86->'97) (Eurocode 3731/3539ASCSB) (ver VAG)	162.812 6 114 021 E864164S
50	Remache pasoruada Escort'95, Fiesta'96, Mondeo'93-> y '97->	162.852 6 743 363 1 629 549 W700615S300
25	Fijac. pasoruada Fiesta '96, Focus, C-Max, Mondeo '00-'07, y parachoques delantero Focus '05, C-Max, fijac. parachoques trasero Fiesta '02-'08, Mondeo '07, fijac. deflector aire Kuga '08	162.957 1 007 932 96FG16K262AA
25	Fijac. revestimiento portón trasero Escort '97, Fiesta '89 y Fiesta '96	162.958 6 181 023 E844072S
25	Fijac. rejilla lavaparabrisas "torpedo" Fiesta '02, Fusion, fij. parachoques delantero Mondeo '96-'00 (ver Renault, VAG)	163.091 1 039 463 W704433S300
10	Fijac. parachoques delantero Mondeo '07->, fijac. aleta y talonera puerta Kuga '08, C-Max '11-> (ver Honda)	163.171 1 429 935 W711712S300
50	Fijac. moldura lateral Fiesta '02, fijac. moldura inferior puerta Focus '08, fijac. tapizados interiores Kuga '08 (ver Renault, VAG)	163.306 1 324 866 W709987S300
50	Fijac. tapizados puerta y faro delantero Fiesta '02, Fusion, Focus '98-'04 (ver Mazda)	163.369 1 088 761 W706182S300
25	Fijac. tapizados interiores S-Max, Galaxy '06	163.442 4 605 824 W709176S300
25	Fij. pasoruada delantero Fiesta '02->'08, Fusion, Focus '02->'05, tapiz. portón tras. Transit '00->'06, fijac. protector interior ruedas traseras Transit '06->, fijac. aislador salpicadero Fiesta '08->	163.734 1 028 521 W701054S300
25	Fijación parrilla radiador Focus '01-> y '04->, C-Max '03 y '07->, Kuga '08, Mondeo '00->'07, Transit Connect '02->	163.735 1 125 799 1S7X8C162AA
25	Fijac. pasoruada trasero Fiesta '08->	163.918 1 639 908 8A61A02737AA



6,7 x 6,7  
Tornillo Ø 3,9



**162.963**

6,7 x 12,9  
Tornillo Ø 2,9



**162.851**

7 x 11,7  
Tornillo Ø 4,2



**163.767**

7 x 7  
Tornillo Ø 3



**162.238**

7 x 7  
Tornillo Ø 4,2



**162.715**

7,5 x 10  
Tornillo Ø 5,5



**163.351**

7,5 x 11,4  
Tornillo Ø 2,9



**163.298**

7,5 x 8,5  
tornillo Ø 5



**163.921**

8 x 10  
tornillo Ø 5,5



**162.955**

8,2 x 8,2  
Tornillo Ø 4,2



**163.439**

9,5 x 9,5  
Tornillo Ø 4,8



**162.480**

9,5 x 9,5  
Tornillo Ø 6,35



**163.367**

9,5 x 14  
Tornillo Ø 4,8



**163.180**

U.E.	DESCRIPCION		Ref. Adaptable
100	Taco fijac. - varios usos - Fiesta (ver Fiat, Renault, Seat)	<b>162.238</b>	1 416 795 114301ES
25	Taco fijación puerta Escort '95, Fiesta '89, Focus, Ka, Mondeo '93-'00	<b>162.480</b>	1 659 672
50	Taco fijac. pasoruada y varios usos Escort '95, Fiesta '89-'96, Fiesta '96, Focus '98, Galaxi '06, Ka '97, Puma '98, Mondeo '97, S-Max	<b>162.715</b>	6 695 013 W700578S300
50	Taco fijac. pasoruada Escort'95, Fiesta'96, Mondeo, fijac. portón trasero Escort, fijac. tapizados Granada, Sierra	<b>162.851</b>	1 634 125 E826292S
25	Fijac. pasoruada Ka, Fiesta'89, Fiesta'96, Granada, Puma, Escort, Mondeo, fijac. moldura exterior Escort, fijac. rejilla Mondeo '96-'00, fijac. tapizados interiores Mondeo '00-'07	<b>162.955</b>	6 150 260 E826163S
50	Fijac. intermitente del. a parachoques Focus '98, fijac. panel puerta delantero Transit '00-'06 (monta con 164.685)	<b>162.963</b>	1 027 000 W702087S300
10	Taco fijacion faro Focus	<b>163.180</b>	6 156 396 87BG13N129AA
50	Taco fijac. revestimientos interiores Mondeo '94-'00 y '00-'07	<b>163.298</b>	6 195 721 W700078S300
25	Taco fijac. protectores motor Escort, Mondeo, Puma, fijac. parachoques Mondeo '96-'00, fijac. columna dirección Fiesta '08, fijac. deflector interior Mondeo '00-'07	<b>163.351</b>	1 019 377 W704408S300
25	Taco fijac. parachoques y torpedo Fiesta, C-Max '03 y '11->, fijac. parachoques Fiesta '02, Fusion, fijac. apertura capó Focus '98 y '05, Mondeo '93->'07, fijac. codo lavaparabrisas Transit Connect '02	<b>163.367</b>	6 549 354 90BG17K657AA
50	Taco fijac. revestimientos interiores Fiesta '02, Focus '05, C-Max, parachoques delantero Transit '06 (ver Opel)	<b>163.439</b>	1 335 795 W709859S300
50	Taco fijac. parachoques trasero Ka '96->, fijac. tapizados puerta Focus '04->, C-Max '03->'07	<b>163.767</b>	1 060 382 W703829S300
50	Taco fijac. moldura inferior puerta Focus '04, C-Max '03->'11, fijac. moldura lateral Focus Berlina '98	<b>163.921</b>	1 073 073 W706006S300

10 x 10  
Tornillo Ø 4,8



**162.928**

10 x 10  
Tornillo Ø 5,5



**162.718**

10 x 13  
Tornillo Ø 5,5



**162.811**

10 x 14  
Tornillo Ø 6



**163.443**

tornillo Ø 4,2



**162.956**

tornillo Ø 5



**163.368**

tornillo Ø 3,9



**162.949**

tornillo Ø 5



**163.830**

tornillo Ø 6



**162.948**

U.E.	DESCRIPCION		Ref. Adaptable
25	Taco fijac. pasoruada Ford - varios - (ver Fiat)	<b>162.718</b>	
50	Taco fijac. rejilla radiador Fiesta '89-'96, Escort'95, Mondeo'97, Ka'97, Puma'98, y fijación óptica delantera Ka	<b>162.811</b>	6 078 784 81AG13N129AA
25	Taco fijac. pasoruada Fiesta '89 (ver Fiat)	<b>162.928</b>	
50	Fijac. revestimientos (tornillo Ø 6) (ver BMW, Mini, Opel, VAG)	<b>162.948</b>	
50	Fijac. moldura guardabarros Fiesta '89 (tornillo Ø 3,9)	<b>162.949</b>	6 634 877 W700980S300
25	Fijac. pasoruada Fiesta '89	<b>162.956</b>	6 185 845 E864338S
25	Taco fijac. aletas y pasoruada C-Max, Focus '98->'04 y '05, Transit Connect '02, fijac. capó Mondeo '00-'07	<b>163.368</b>	1 060 318 W703069S300
25	Taco fijac. puertas Fiesta '89-'96, Escort	<b>163.443</b>	6 084 040 E826222S
50	Fijac. rejilla parabrisas Ka '08-> (ver Fiat)	<b>163.830</b>	1 580 312 W303562



162.261



162.262



162.423



163.135



163.684



163.231



163.765



162.971



162.651



162.952



163.016



163.233



181.404\*

\* (imagen NO a tamaño real)



162.918



162.972

U.E.	DESCRIPCION	Ref. Adaptable
25	Fijac. moldura cristal Fiesta	162.261 6 040 784
25	Fijac. vierteaguas Fiesta	162.262 6 053 937
50	Fijac. revestimientos interiores Fiesta	162.423 1 443 038 3014E7902358AFA
10	Fijac. tubo lavacrystal y varilla capó Fiesta '89	162.651 6 183 092
10	Fijac. cableado motor Fiesta, Escort (ver BMW, Opel)	162.918 6 105 034 82GG14197D2A
10	Fijac. varilla capó Fiesta '96	162.952 1 051 701
25	Fijac. varilla puerta C-Max, Escort '95, Fiesta ->'08, Focus '98 y '05->, Puma, S-Max '06->, Transit Connect '02	162.971 6 758 612 W700930S300
25	Fijac. cableado puerta Escort, Fiesta ->'02, Focus '98->'04, Galaxy, Mondeo '93->'07, Transit	162.972 6 180 955 91AG14197AFA
25	Fijac. varilla capó Fiesta '96, Focus, Ka, Mondeo, Transit	163.016 6 870 622 1 629 999
50	Fijac. juntas estanqueidad Ford Fiesta '02, Fusion (ver PSA, Renault)	163.135
25	Fijac. juntas estanqueidad puerta Galaxy (ver VAG)	163.231
10	Clip fijacion varilla capó Escort, Fiesta ->'02, Ka, Transit ->'00	163.233 6 068 981
25	Fijac. juntas goma puerta Mondeo	163.684 1 042 065 W702985S300
10	Fijac. varilla soporte capó Galaxy '06->, Mondeo '07->, S-Max, Transit '06->	163.765 1 216 747 W709046S300
-	Tirante bandeja posterior Ford Fiesta, Sierra (long.total 365 mm.)	181.404 1 648 812 87BBA46812AYYB7



190.365\*



190.363\*

\* (imagen 1/2 tamaño real)



163.124



162.947



163.957



163.131



163.132



163.123



163.515



163.516



163.517



163.518



163.805

U.E.	DESCRIPCION	Ref. Adaptable
25	Fijac. molduras parabrisas Concerto SJ4 '91->'95 (ver Rover) (Eurocode 3943ASCHB)	162.947 91517 SJ4 003
25	Fijac. moldura parabrisas Civic '91->, Integra (ver Rover) (Eurocode 3940/3948ASCS)	163.123 91520-SR3-003
10	Fijac. parrilla parabrisas Ballade, City, Civic '92->'00 (3 y 5 puertas), CRV '97->'01, CRX, HRV, Integra, Logo (Eurocode 3948ASCC)	163.124 91515-SR3-000
10	Fijac. moldura parabrisas Civic '91->, Integra Coupe '93->'98 (Eurocode 3954ASCH) (ver Rover)	163.131 91511-ST3-E00
10	Fijac. moldura parabrisas Accord '90->'93 (ver Rover) (Eurocode 3936ASCSS6B)	163.132 91525-SM4-003
10	Fijac. panel puerta y tapizados interiores - varios modelos -	163.515 91560-S9A-A51
10	Fijac. panel puerta y tapizados interiores - varios modelos -	163.516 38993-634-810
10	Fijac. panel puerta y tapizados interiores Accord '03->'07, Civic '02->'05, CRV '08->, Odyssey '05->	163.517 91560-S9A-A01
10	Fijac. panel puerta y tapizados int. Accord '08->, Civic '05->, CRV '02->, Jazz, Odyssey '05->	163.518 91560-S6A-003
10	Fijac. panel puerta y tapizados int. Accord '94->'02, Civic '02->'05, CRV '97->'01	163.805 91560-SP0-003
10	Fijac. moldura lateral parabrisas Civic '06-> (Eurocode 3992ASCV2B)	163.957 91570-SJD-003
1	Bomba lavaparabrisas Accord y Civic (ver Hyundai, Kia, Mazda, Mitsubishi, Subaru, Suzuki, Toyota)	190.363 76806-SH3-003 76806-SV5-A02
1	Bomba lavaparabrisas Accord ->'97 (ver Daewoo, Ford, Hyundai, Mitsubishi, Suzuki, Toyota)	190.365 75806- SN7-E05



163.191



163.294



163.812



163.804



163.159



163.896



163.618



163.173



163.174



163.172



163.281



163.192



163.519



163.520

U.E.	DESCRIPCION	Ref. Adaptable
25	Clip fijac. parrilla radiador - varios mod. - (ver Mazda, Opel, Toyota)	163.159
25	Fijac. revestimientos interiores Accord, Civic, CRX, Integra, Legend, Logo, NSX, Odyssey, Prelude (ver Mazda)	163.172 75522-611-000 75522-611-003
25	Fijac. revestimientos interiores - varios modelos -	163.173 906666890030
25	Fijac. varios usos Accord '99->'02, Prelude '89->'91	163.174 91606-SE3-003
25	Fijac. panel puerta y otros usos Civic '96->'05, Odyssey '99->'04	163.191 91530-ST5-003
25	Fijac. varios usos Civic, Prelude	163.192 90656-671-631
25	Fijac. revestimientos interiores, pasoruada y otros usos Accord, Civic, CRV, Legend, NSX, Prelude (ver Hyundai)	163.281 90672-671-811
10	Fijac. revestimientos interiores, junta capó y junta puerta Accord ->'89, Civic ->'91, CRX ->'91, NSX '97->'01, Prelude	163.294 90664-671-003
25	Fijac. panel puerta y tapizados interiores Accord -todos-, Civic -todos-, CRV '07->, CRX '84->'91, Element '03->, Insight, Integra, Jazz '07->, Odyssey '95->, Prelude '79->'01, Pilot '03->	163.519 90662-SB2-003
10	Fijac. tapizados portón Accord, Acty, Civic, CRX, HRV, Logo, Prelude, Shuttle, fijac. parachoques Jazz (ver Mazda, Nissan, Toyota)	163.520 90661-SC7-003
10	Fijación tapizados interiores Accord '83->'89, Civic '80->'87, CRX '84->'87, Integra, Legend, Prelude '79->'87	163.618 90672-671-003 90674-SK3-E00
10	Fijac. talonera puerta Accord '90->'07, Civic '92->'00, CR-V '97->'01	163.804 91513-SM4-000
25	Fijac. junta goma puerta Accord '98->'07, Civic '01->'05	163.812 91568-SR2-003
50	Fijac. insonorizante capó Accord '03->, Civic '06->, CR-V, Insight '10->, Jazz	163.896 91518-SM4-003



U.E.	DESCRIPCION	Ref.	Adaptable
10	Fijac. pasoruada Accord '90-'97, Balade, Civic ->'00, Concerto, CRX ->'91, Integra, Legend, Prelude '90->'95, NSX (ver Rover)	163.035	91512-SM4-003
10	Fijac. parrilla parabrisas Accord '90-'00, Civic, Legend '96-'00 (Eurocode 3936ASCHB / 7020ASCSS4B) (ver Rover)	163.036	91508-SM4-003
10	Fijac. revestimiento parachoques Accord '92->'97, Civic '01-'02, Concerto, CRX, Legend ->'95, Prelude ->'96 (ver BMW, Daewoo, Mini, Rover)	163.037	91503-SP0-003
10	Fijac. parachoques Accord '92-'97 y otros modelos (ver Daewoo)	163.163	91502-SP0-003
10	Fijac. parachoques Accord '97->, Civic '97->, CRV '97->, Jazz '05->, Odyssey '96->, FRV, HRV, Insight, Integra, Legend, NSX, fijac. talonera puerta CR-V	163.164	91503-SZ3-003
10	Fijac. revestimientos interiores - varios modelos -	163.168	90687-SB0-003
10	Fijac. revestimientos interiores y talonera puerta Civic'92->'00, CRV '00->'01, Integra, Legend, Odyssey '01->'04, Prelude '83->'87 (ver Rover)	163.169	90688-SB0-003 90688-SB0-013
10	Fijac. rejilla entrada de aire Civic '92->'00, CRV '97->'01, Odyssey	163.170	91508-SR3-000
10	Fijac. pasoruada Accord '96->, Civic '96->'06 y '06->, CRV '97->, HRV, Insight, Jazz '07 (ver Ford)	163.171	91501-S04-003
10	Fijac. parachoques, molduras pasoruada y tapizados interiores Accord ->'07, Civic '01->, CRV '02->'06, Jazz (ver Nissan, Volvo)	163.277	91545-SE0-003
10	Fijac. pasoruada - varios modelos - (ver Fiat, Suzuki, Toyota)	163.476	
10	Fijac. tapizados interiores Accord '03->'07, Civic '01->, CRV '02->'06, Jazz '07->, NSX, S2000 '00-> (ver Mitsubishi, Nissan)	163.482	91545-SE0-003
10	Fijac. parachoques Accord '98->'07, Civic '01->'05, CR-V '02, Element, Jazz, Insight, Odyssey (ver Nissan)	163.802	91503-SZ5-003
10	Fijac. moldura talonera puerta CR-V '97->'06	163.813	90505-SX0-003



\* (imagen 1/2 tamaño real)



U.E.	DESCRIPCION	Ref. Adaptable
10	Fijac. pasoruada y parachoques Accent, Azera, Coupé, Elantra, Entourage, Genesis, Getz, Santa Fe, Sonata, Tucson, ix35, ix55 (Veracruz), XG300/350, Kia Sorento, Sportage (ver Mazda, Toyota)	163.503 86590-28000
1	Soporte cristal elevalunas derecho Accent	163.548
1	Soporte cristal elevalunas izquierdo Accent	163.549
25	Fijac. junta goma puerta Hyundai Accent, Atos, Elantra, Santa Fe, Sonata, Tucson, ix55 (Veracruz), Kia Picanto, Rio, Sorento, Sportage	163.700 82134-22000
25	Fijac. junta goma puerta Hyundai Elantra '91->'00	163.701 82852-28000
25	Fijac. junta goma puerta Hyundai Accent ->'99, Atos	163.702 82134-37000
25	Fijac. junta goma puerta Hyundai Accent '99->'06, Atos, Coupé, Galloper, Santa Fe, Sonata	163.703 82132-27100
25	Fijac. junta capó Kia Carnival, Picanto, Rio	163.704 86438-27100
25	Fijac. insonorizante capó Hyundai Accent '06, Azera '05, Coupé, Elantra, Entourage, Genesis, Santa Fe '03, Sonata, Tucson '04, Veracruz '06, XG300/350, Kia Sorento, Sportage	163.976 81126-37010
1	Bomba lavaparabrisas -varios modelos- (ver Honda, Mazda, Mitsubishi, Subaru, Suzuki, Toyota)	190.363 98510-29600
1	Bomba lavaparabrisas Accent, Coupé, Excel, Lantra, Matiz, Nexia, Sonata'98 (ver Daewoo, Ford, Honda, Mitsubishi, Suzuki, Toyota)	190.365 98510-3B000



U.E.	DESCRIPCION	Ref. Adaptable
10	Fijac. moldura lateral puerta Hyundai Elantra, fij. parrilla radiador Hyundai Sonata	163.266 87770-28000
25	Fijac. parachoques Hyundai Accent, Santa Fe, Tucson, Kia Sorento, Sportage fijac. revestimientos interiores Hyundai Coupé (Tiburón), Elantra, Sonata (ver Honda)	163.281 97519-22000
50	Fij. moldura lateral Hyundai Getz, Matrix, Santa Fe, Sonata, Tucson, Kia Carnival, Sorento, Sportage fijac. pasorueda Hyundai Accent, Elantra, Genesis, Santa Fe, Sonata, Kia Sorento, fijac. parachoques Hyundai Tucson, ix55 (Veracruz), Kia Sportage	163.688 86848-22000
25	Fijación parachoques y tapizados interiores Accent, Atos, Azera, Elantra, Genesis, Sonata, fijac. moldura lateral Galloper	163.689 85744-28000
25	Fijac. moldura lateral Hyundai Accent, Getz, Matrix, Kia Sorento	163.690 87756-1C000
25	Fijac. moldura lateral Hyundai Accent, Atos, Entourage, Matrix, Santa Fe, Sonata	163.691 87756-35000
25	Fijac. parrilla radiador Tucson, fijac. moldura lateral Hyundai Genesis, Sonata, Terracan	163.692 87702-H1000
25	Fijac. parrilla radiador Elantra, fij. moldura lateral Hyundai Terracan	163.693 87703-H1000
25	Fijac. moldura lateral Hyundai Accent, Atos	163.694 87770-02000
25	Fijac. moldura lateral Hyundai Atos, Santa Fe, Kia Picanto, Sorento	163.695 87719-02500
25	Fijac. moldura lateral Hyundai Entourage, Santa Fe, Sonata, Tucson, ix55, Kia Sorento, Sportage	163.696 87756-2E000
25	Fijac. moldura lateral Hyundai Azera, Coupé, Tiburon, XG300/350	163.697 87758-39000
25	Fijac. moldura lateral Hyundai Coupé (Tiburón), Entourage, Genesis, Santa Fe, Tucson, ix55, Kia Sorento, Sportage	163.698 87759-27000
25	Fijac. moldura lateral Hyundai Entourage, Getz, Sonata, fijac. tapizados puerta Hyundai Elantra	163.699 87756-38000
25	Fijación moldura lateral Hyundai Accent, Atos, Coupé, H-100, ix35, Matrix, Santa Fe, Tucson, Kia Picanto, Sorento, Sportage	163.892 87758-35000
25	Fijac. tapizados puerta Hyundai Accent '99, Elantra '00, Genesis, Santa Fe, Sonata, Tucson, XG300/350, Kia Sorento, Sportage	163.962 82315-38000 82315-27000 82315-33010 82315-33020





163.706



163.359



163.650



163.251



163.250



163.621



163.161



163.162



163.259



163.193



163.258



163.356

U.E.	DESCRIPCION	Ref. Adaptable
25	Clip fijac. revestimientos interiores LS430, RX300 (ver PSA, Suzuki, Toyota)	163.161 90467-10161
25	Clip fijac. spoiler y protección lado puerta RX300 (ver Toyota)	163.162 90467-10162
25	Fijac. insonorizante capó IS200/300, LS400/430, RX300 '00->'03, SC430 (ver Toyota)	163.193 90467-08124
25	Fijac. panel puerta y tapizados interiores LS400, RX300 '00->'03 (ver Suzuki, Toyota)	163.250 67771-12050
10	Fijac. moldura portón trasero IS200/300, GS300/430 (ver Toyota)	163.251 75819-12040
10	Fijac. aislamiento capó IS250/350, IS F, IS250C, GS30/35/43, GS300/450, LS430/460/600, LX470/570, GX460, RX300/350/400H/450H (ver PSA, Toyota)	163.258 90467-09050
25	Fijación goma capó CT200H, IS250C, IS F, GS30/35/43, GS300/450, LS400/430/460/600, RX300/330/350/400450H (ver Toyota)	163.259 90467-08011
25	Fijac. tapizados asientos LS430 '00->'06 (ver Toyota)	163.356 90467-05096
10	Fijac. moldura parabrisas GS300, GX460, LS430, LS460, LS600H, LX570 (Eurocode 8310ASCH) (ver Toyota)	163.359 56115-30100
10	Fijac. tapizados interiores IS250/350, IS F, GS30/35/43, GS450H, LS430, LS460, RX300/330/350, RX400H (ver Toyota)	163.621 90467-10167
10	Fijac. moldura lateral parabrisas IS F '08->, GX460 '09-> (Eurocode 8371ASCSS) (ver Toyota)	163.650 75545-53010
10	Fijac. moldura superior parabrisas IS F, IS 250C, LS430/460/600, LX570, GS30/35, GS450, GX460, RX300/350/400H/450H (Eurocode 8310ASCH6B) (ver Toyota)	163.706 56116-22050



163.526



163.527



163.528



163.160



163.165



163.249



163.167



163.476



163.529



163.530



163.166



163.981



163.296



163.297



163.358

U.E.	DESCRIPCION	Ref. Adaptable
10	Clip fijac. moldura pasoruada RX300 '00->'03 (ver Toyota)	163.160 53879-14010
25	Fijac. pasoruada RX270/350/450H, RX300, RX400H (ver Toyota)	163.165 90189-06013
10	Fijac. para choques IS200/300 '99->'05 (ver Nissan, PSA, Toyota)	163.166 90467-08185
10	Fij. mold. pasoruada IS200/300 '99->'05, IS250/350 '05, LS430, fij. bajos carrocería IS250C, GS300 (ver Toyota)	163.167 90467-07166
10	Fijac. moldura pasoruada LX470 (ver Toyota)	163.249 53879-60010
10	Fijac. para choques LS400, SC430 (ver Toyota)	163.296 90467-09093
10	Fijac. tubo inyección gasolina IS200/300 (ver Toyota)	163.297 90467-09189
10	Fijac. para choques y rejilla radiador IS250/350 '05->, IS250C '09->, IS F '08-> (ver Toyota)	163.358 52161-16010
10	Fijac. pasoruada SC430 '01-'10, otros usos GX460 '10->, LX570 '07-> (ver Honda, Suzuki, Toyota)	163.476 90467-07164
10	Fijac. moldura lateral puerta RX300 '00->'03 (ver Toyota)	163.526 75397-48030
10	Fijac. moldura lateral puerta RX300 '00->'03 (ver Toyota)	163.527 75395-33030
10	Fijac. moldura lateral puerta GS30/35/43/460, GS450H (ver Toyota)	163.528 62955-12010
10	Fijac. moldura pasoruada GS30/35, GS450H, GX460, fijac. protector maletero RX300/350/400H (ver Toyota)	163.529 90467-07201
10	Fijac. bajos carrocería CT200H '10-> (ver Toyota)	163.530 90467-07183
10	Fijac. para choques trasero LS400 (ver PSA, Toyota)	163.981 90467-09128



190.363\*

\* (imagen 1/2 tamaño real)



163.159



163.507



163.521



163.522



163.803



163.472



163.531



163.473



163.369



163.503



163.474



163.172



163.275



163.520



163.619

U.E.	DESCRIPCION	Ref. Adaptable	
25	Clip fijac. parrilla radiador - varios modelos - (ver Honda, Opel, Toyota)	163.159	
25	Fijac. varios usos Mazda 323, 626 Wagon (ver Honda)	163.172	9991-00-412
50	Fijación parachoque trasero, panel puerta y tapizados Mazda 2, 3, 5, 6, 121, 323, 626, Demio, MX3, MX5, RX8	163.275	9991-00-501
50	Fijac. rejilla parabrisas "torpedo" Mazda 2 (ver Ford)	163.369	9X706182X0
10	Fijac. tapizados interiores Mazda 6, 626, Demio	163.472	GA2K-68-AB1
10	Fijac. tapizados interiores Mazda 323, 626, Premacy	163.473	GA7B-50-797A
10	Remache roscado fijac. pasoruada y aletas Mazda 323, 626, Demio	163.474	B455-56-143
10	Fij. pasoruada y parachoques - varios modelos- (ver Hyundai, Toyota)	163.503	9926-50-625
10	Fijac. moldura parabrisas Mazda 323, 929, Mercury Tracer, Truck (Eurocode 5117ASCS)	163.507	HA01-50-609 HA01-50-609A
10	Fijac. tapizados interiores - varios - (ver Honda, Nissan, Toyota)	163.520	H001-50-841
50	Fijac. varios usos Mazda - varios modelos -	163.521	9926-40-426
50	Fijac. varios usos Mazda - varios modelos -	163.522	9926-40-543A
10	Fijac. panel puerta - varios modelos - (ver Suzuki, Toyota)	163.531	9927-40-825
25	Fijac. aletas, pasoruada y cubre cárter - varios modelos - (ver Toyota)	163.619	
10	Fijac. moldura parabrisas Mazda Demio (Eurocode 5157ASCVB)	163.803	D20150797
1	Bomba lavaparabr. -varios modelos- (ver Honda, Hyundai, Kia, Mitsubishi, Subaru, Suzuki, Toyota)	190.363	LA01-67-482 FB01-67-482

Ø 4,8 x 15  
arandela Ø 15



161.473

Ø 4,8 x 18  
arandela Ø 15



161.474

Ø 5,5 x 19  
arandela Ø 22



161.742

Ø 6,3 x 19  
arandela Ø 18



162.556

Ø 6,3 x 19  
arandela Ø 22



161.743

Ø 2,9



161.487

Ø 2,9



161.757

Ø 4



161.414

Ø 4,2



161.492

Ø 4,2



161.493

Ø 4,8



161.498

Ø 4,8



161.702

Ø 4,8



161.748

Ø 4,8



161.749

Ø M5



161.703

Ø 5,5



161.746

Ø 6,3



161.747

U.E.	DESCRIPCION	Ref. Adaptable
100	Clip fijac. varios usos Mercedes - varios - (ver Ford)	161.414 000 994 01 45
50	Tornillo Ø 4,8 x 15 (aro Ø 15), varios usos (ver varias marcas)	161.473
50	Tornillo Ø 4,8 x 18 (aro Ø 15), varios usos (ver varias marcas)	161.474 123 990 01 36
50	Clip fijac. varios usos Mercedes - varios -	161.487 001 994 04 45 123 994 01 45
50	Clip fijac. varios usos Mercedes - varios - (ver Ford)	161.492 140 994 10 45
50	Clip fijac. varios usos Mercedes - varios - (ver BMW, Ford)	161.493 000 994 25 45
50	Clip fijac. varios usos Mercedes - varios - (ver BMW, VAG)	161.498 000 994 05 45
50	Clip fijac. varios usos Mercedes - varios modelos - (ver BMW)	161.702 000 994 14 45
50	Clip fijac. varios usos Mercedes - varios modelos - (ver Fod, Renault)	161.703 003 994 42 45 002 994 20 45
50	Tornillo Ø 5,5 x 19 (aro Ø 22), suj. guardabarros (ver varias marcas)	161.742
50	Tornillo Ø 6,3 x 19 (aro Ø 22), suj. guardabarros (ver varias marcas)	161.743 000 990 68 36
50	Clip fijac. rejillas frontales W124, W126 y varios	161.746 000 994 47 45 126 994 12 45
50	Clip fijac. revestimientos puerta Mercedes - varios modelos - (ver Ford)	161.747 000 994 09 45
25	Clip fijac. protectos cárter/motor Mercedes - varios modelos -	161.748 004 994 31 45
25	Clip fijac. protectos cárter/motor Mercedes - varios modelos -	161.749 002 994 80 45
50	Clip fijac. tapa altavoces Mercedes - varios modelos -	161.757 001 994 54 45 000 994 42 45
50	Tornillo Ø 6,3 x 19 (aro Ø 18), sujeción guardabarros (ver BMW, Ford, Opel, VAG)	162.556



190.352\*



190.353\*



190.371\*



190.355\*



190.378\*



190.370\*

\* (imagen 1/2 tamaño real)



163.057



163.405



163.406



163.550 - Dcho.  
163.551 - Izdo.



163.659 - Dcho./Izdo.

U.E.	DESCRIPCION	Ref. Adaptable	
10	Fijac. varilla capó ML (ver Opel)	163.057	
10	Fijac. varios usos Mercedes	163.405	601 078 20 41
50	Fijac. gomas puerta y capó Mercedes 300, 400, 500,600	163.406	000 997 13 86
1	Soporte cristal elevalunas derecho Vito	163.550	
1	Soporte cristal elevalunas izquierdo Vito	163.551	
1	Soporte cristal elevalunas delantero derrecho e izquierdo Mercedes S320	163.659	
1	Bomba lavaparabrisas Mercedes 190, clase C, Sprinter, Vito (W368) (ver VAG)	190.352	202 869 00 21
1	Bomba lavaparabrisas Mercedes clase A (W168), clase E (W210) (ver BMW, VAG)	190.353	210 869 10 21
1	Bomba lavaparabr. Mercedes W163, W202, W203, W210, W211, CLK, SLK (ver BMW, Smart, VAG)	190.355	202 869 02 21
1	Bomba lavaparabrisas MB 190 (W201), clase C '93->'00 (W202), clase E ->'02 (W124 / W210)	190.370	140 869 02 21 202 869 01 21
1	Bomba lavaparabrisas Mercedes clase G (W460), Sprinter, Vito (ver Opel, VAG)	190.371	129 869 00 21
1	Bomba lavaparabrisas Mercedes Clase B (W245), Clase C (W204) (ver Mini, VAG)	190.378	204 866 02 21



162.730



163.908



162.731



163.909



162.732



163.461



163.462



163.783



163.463



163.784

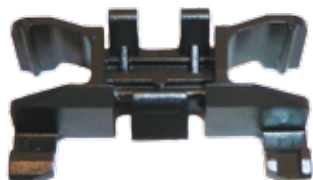

163.943



162.919



163.537



163.640



163.464

U.E.	DESCRIPCION	Ref. Adaptable
10	Fijac. moldura techo-parabrisas (190-202) (Eurocode 5328ASCST)	162.730 201 698 01 60
10	Fijac. moldura techo-parabrisas (190-202) (Eurocode 5328ASCST1B)	162.731 201 698 06 60
10	Fijac. moldura techo (190-202)	162.732 201 698 02 60
10	Fijac. moldura parabrisas izquierdo Vito (W638) Clase V (blanca) (Eurocode 5428ASCVS)	162.919 638 984 08 61
10	Fijac. molduras superior parabrisas Clase E '95->'02 (W210) (Eurocode 5337ASCST)	163.461 210 690 02 13
10	Base parabrisas Clase E '02->'08 (W211) (Eurocode 5347ASCST)	163.462 211 988 00 81
10	Fijac. molduras lateral parabrisas Clase A '05-> (W169), Clase B '05-> (W245)	163.463 012 988 60 78
25	Fijac. rejilla parabrisas («torpedo») Clase A '05-> (W169), Clase B '05-> (W245) y fijac. moldura portón trasero clase C '00->'07 (W203)	163.464 008 988 73 78
10	Fijac. moldura parabrisas derecho Vito (W638) Clase V (negra) (Eurocode 5428ASCVR)	163.537 638 984 09 61
25	Fijac. rejilla parabrisas («torpedo») Clase C '07-> (W204) (Eurocode 5364ASSSB) fijac. otros usos W123, W124, W126, W211, W219	163.640 123 990 05 92 126 990 03 92
10	Fijac. molduras techo-parabrisas Clase C (W203) (Eurocode 5352ASCCD)	163.783 203 690 00 13
10	Fijac. molduras parabrisas Vaneo	163.784 009 988 16 78
10	Fijac. moldura techo-parabrisas Clase C (W204) (Eurocode 5364ASCSDS)	163.908 204 690 06 14
10	Fijac. moldura techo-parabrisas Clase E (W211) '02->'08 (Eurocode 5347ASCS)	163.909 011 988 94 78
10	Fij. mold. techo-parabrisas Clase A '04-> (W169) y Clase B '05-> (W245) (Eurocode 5358ASCHDS)	163.943 000 991 58 71

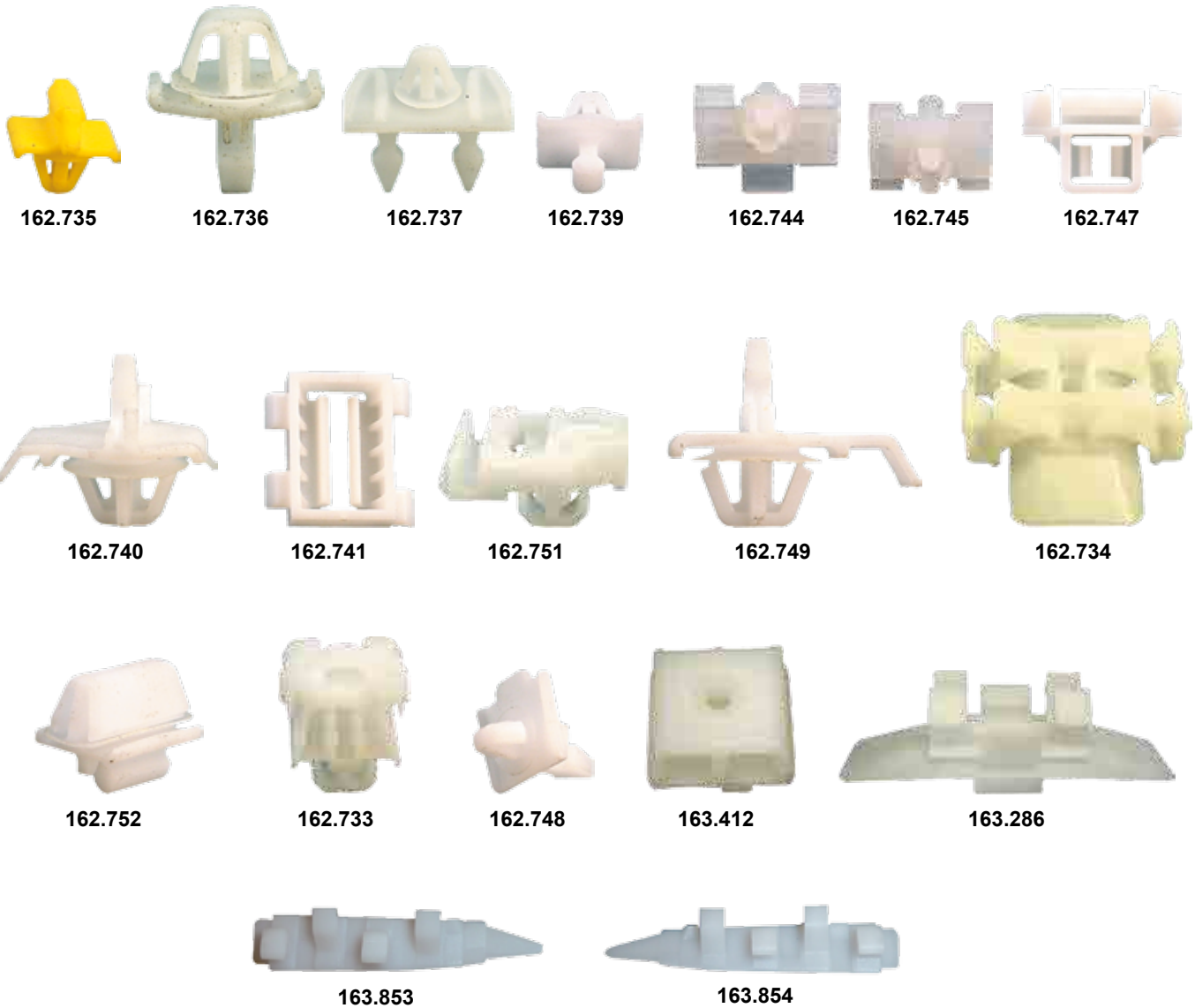

U.E.	DESCRIPCION	Ref. Adaptable
10	Fijac. moldura (124)	<b>162.733</b> 124 988 04 78
10	Fijac. moldura puerta Clase C (W202, W203), Clase E (W211), Sprinter, Vito (W638/639)	<b>162.734</b> 007 988 71 78
10	Fijac. moldura (190)	<b>162.735</b> 001 988 60 81
10	Fijac. moldura (190)	<b>162.736</b> 001 988 48 81
10	Fijac. moldura (190)	<b>162.737</b> 001 988 46 81
10	Fijac. moldura (190)	<b>162.739</b> 001 988 44 81
10	Fijac. moldura (190)	<b>162.740</b> 001 988 63 81
10	Fijac. moldura (190)	<b>162.741</b> 001 988 50 81
10	Fijac. moldura (190)	<b>162.744</b> 006 988 30 78
10	Fijac. moldura (190)	<b>162.745</b> 201 988 03 78
10	Fijac. moldura (190)	<b>162.747</b> 001 988 51 81
10	Fijac. moldura (124)	<b>162.748</b> 001 988 49 81
10	Fijac. moldura (190)	<b>162.749</b> 001 988 47 81
10	Fijac. moldura (190)	<b>162.751</b> 006 988 35 78
10	Fijac. moldura (190-202)	<b>162.752</b> 001 988 45 81
10	Fijac. moldura lateral (124)	<b>163.286</b> 006 988 72 78
10	Fijac. moldura (124)	<b>163.412</b> 124 990 00 52
10	Fijac. moldura lateral izquierda (parte trasera) 124, 200, 250, 300, 320	<b>163.853</b> ● 006 988 75 78
10	Fijac. moldura lateral derecha (parte trasera) 124, 200, 250, 300, 320	<b>163.854</b> ● 006 988 76 78

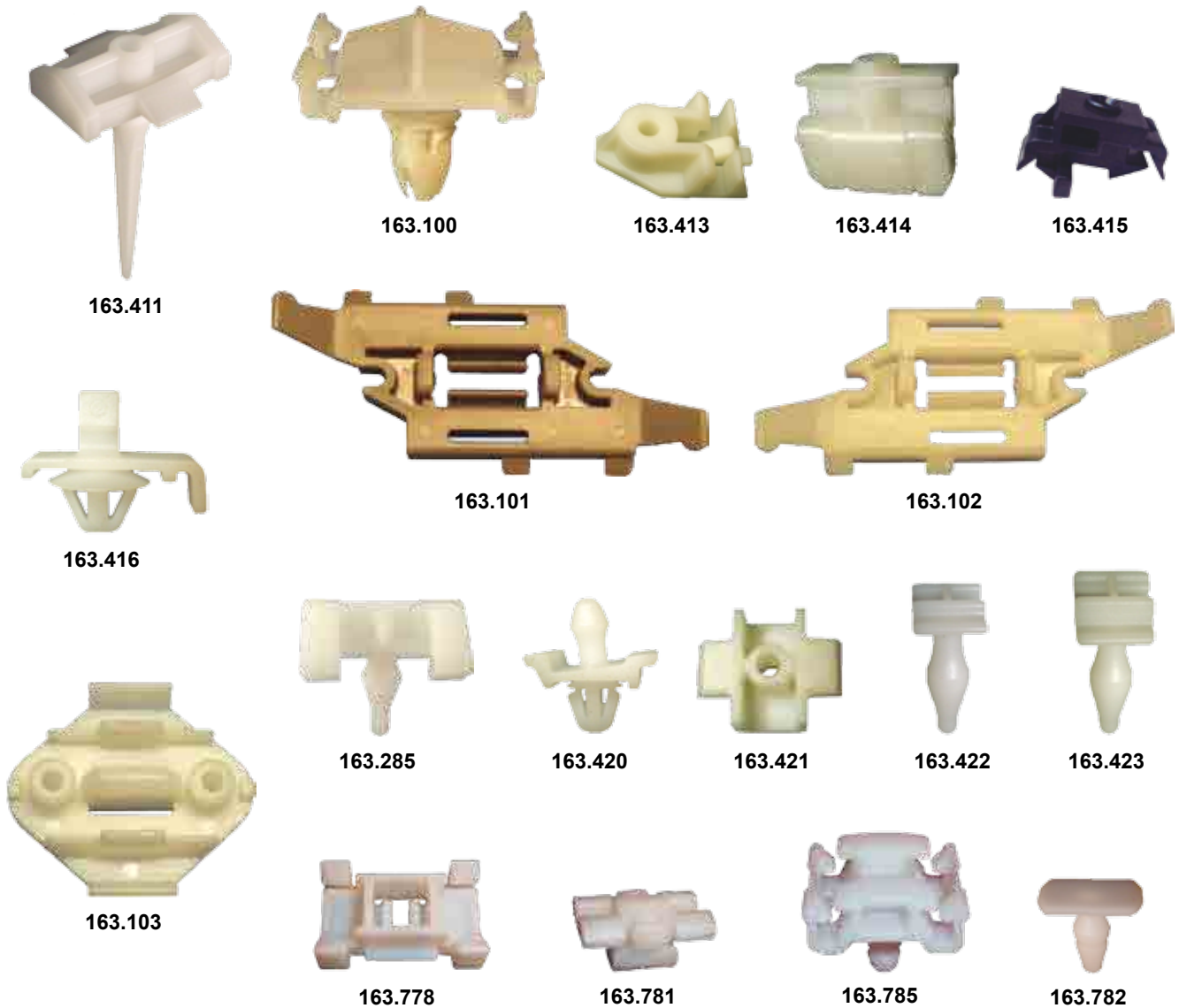

U.E.	DESCRIPCION	Ref. Adaptable
10	Fijac. moldura lateral (parte delantera) Clase C (W202, W208), Clase E (W210)	163.100 001 988 80 81
10	Fijac. moldura lateral (parte derecha trasera) Clase C (W202)	163.101 007 988 74 78
10	Fijac. moldura lateral (parte izquierda trasera) Clase C (W202)	163.102 007 988 73 78
10	Fijac. moldura lateral (parte trasera) Clase C (W202) (monta junto con 163101 y 163102) (ver VAG)	163.103 007 988 76 78
10	Fijac. moldura lateral - varios -	163.285 001 988 31 81
10	Fijac. moldura lateral - varios -	163.411 001 988 36 81
10	Fijac. moldura lateral (190-201)	163.413 002 994 64 45
10	Fijac. moldura lateral (190-201)	163.414 002 994 65 45
10	Fijac. moldura lateral - varios -	163.415 002 994 44 45
10	Fijac. moldura lateral - varios -	163.416 001 988 57 81
10	Fijac. moldura lateral 200, 220, 230, 300, 320	163.420 001 988 32 81
10	Fijac. moldura lateral 200, 230, 250, 260, 300	163.421 002 994 75 45
10	Fijac. moldura lateral 300, 400, 500, 600	163.422 140 698 01 60
10	Fijac. moldura lateral 300, 400, 500, 600	163.423 002 997 02 86
10	Fijac. talonera puerta W124	163.778 001 988 56 81
10	Fijac. moldura Clase C (W201)	163.781 005 988 72 78
25	Fijac. parrilla radiador Clase C (W203), Clase E (W210)	163.782 001 988 97 81
10	Fijac. moldura lateral Clase C (W203)	163.785 011 988 28 78





U.E.	DESCRIPCION		Ref. Adaptable
100	Fijac. molduras portón trasero Vito (W638) (ver Fiat, Ford, Seat, Renault)	162.238	638 988 02 25
10	Boca de fijación para perno moldura lateral (190-202)	162.738	001 988 29 81 001 988 49 81
25	Boca fijac. moldura (varios modelos)	162.746	001 318 53 58 000 988 15 81
25	Boca fijac. molduras -varios modelos-	162.913	001 988 20 81
50	Fijac. pasoruada, revestimientos y varios usos (ver VAG)	162.924	
25	Taco para tornillo Ø 3,5 fijac. rejilla lavaparabrisas "torpedo" Vito (W638), Clase V y otros modelos (ver BMW)	163.063	638 994 08 45
25	Fijac. estribera bajo puerta Serie C 200	163.283	000 988 52 25
25	Boca fijac. molduras Mercedes 210	163.284	001 988 76 81
50	Fijac. pasoruadas, revestimientos y otros usos - varios -	163.287	201 990 00 50
50	Fijac. pasoruadas, revestim. y otros usos - varios - (ver BMW, Mini)	163.288	003 990 02 51
25	Fijac. varios usos Mercedes	163.410	000 988 44 25
25	Boca fijac. molduras (varios modelos)	163.417	202 988 04 81
25	Boca fijac. molduras Mercedes 202	163.418	001 988 77 81
25	Boca fijac. molduras Mercedes 200, 230, 250, 300	163.419	001 988 27 81
10	Fijac. moldura lateral portón trasero Vito (W638)	163.768	638 690 00 13
25	Fijac. tapizados puerta Vito	163.788	631 997 23 86
10	Fijac. panel trasero techo Vito (W638)	163.833	638 695 01 14 638 695 01 09
25	Boca fijac. molduras laterales Mercedes -varios modelos-	163.857	000 988 55 81



162.554



163.773



163.789



163.790



163.791



163.831



163.795



162.953



163.282



163.861



163.407



163.408



163.771



163.424



162.453



162.753



162.934



163.786



163.787

U.E.	DESCRIPCION	Ref. Adaptable
100	Botón fijac. tapizados puertas laterales y traseras Vito (W638) (ver PSA, Renault)	162.453 638 984 13 61
50	Fijac. panel puerta Mercedes Vito (W638) y otros modelos (ver Seat)	162.554 638 984 01 61
50	Botón fijac. tapizados interiores - varios modelos -	162.753 631 984 25 61
100	Botón fijac. tapizados puerta y portón trasero Vito (W638) y tapizados interiores Vito (W639) (ver Nissan, PSA, Renault)	162.934 638 984 16 61 638 984 00 61
50	Fijac. tapizados y panel puerta -varios modelos- (ver Ford)	162.953 006 988 43 78
50	Fijac. panel puerta Mercedes (ver Seat)	163.282 003 988 41 78
25	Fijac. tapizados interiores 240, 270, 320	163.407 463 988 02 78
25	Fijac. tapizados puertas laterales y portón trasero Vito (W639), Sprinter	163.408 000 991 27 71
25	Fijac. tapizados techo furgonetas Mercedes	163.424 000 997 06 02
25	Fijac. tapizados portón trasero Vito (W638)	163.771 638 988 09 78
50	Fijac. tapizados interiores laterales Sprinter, fij. tapizados traseros Clase S (W221) (ver BMW)	163.773 006 988 57 78
25	Fijac. revestimientos interiores W124, W126, W140, W201, W202, W210	163.786 001 988 10 81
25	Fijac. tapizados interiores W124, W126, W140, W201, W202, W210	163.787 001 988 09 81
50	Fijac. tapizados maletero Clase E (W210, W220, W221, W230)	163.789 000 990 57 92
25	Fijac. panel puerta y revestimientos interiores Clase A (W169), Clase B (W245), Clase C (W204)	163.790 000 991 04 98
25	Fijac. revestimientos interiores pilar D Clase C (W204)	163.791 000 991 86 98
10	Fijac. panel puerta Mercedes ML (W163)	163.795 163 988 16 78
25	Fijac. tapizados interiores Clase A (W169), Clase B (W245) (Eurocode 5358BSCH)	163.831 000 991 24 98
50	Fijac. panel puerta -varios modelos- y camiones	163.861 005 988 82 78



163.856



163.855



163.779



163.907



163.926

162.259

163.792

162.456

163.305

163.793

U.E.	DESCRIPCION	Ref. Adaptable
100	Remache fijac. varios usos Mercedes (ver Renault)	162.259 638 984 02 61
50	Remache fijac. varios usos y modelos (ver BMW, PSA, Renault, VAG)	162.456 000 990 34 92
50	Remache fijac. varios usos Mercedes (ver Opel, VAG, Volvo)	163.305 000 990 55 92
10	Fijac. talonera puerta Clase C (W203) y otros usos SLK (W170 / W171)	163.779 009 997 72 81
50	Remache fijac. rejilla calandra Clase C (W201), Clase S (W221), fijac. cristal posterior CLK (W209), fij. moldura portón trasero W124	163.792 124 990 05 92 124 990 90 51
50	Remache fijac. soporte radiador y otros usos -varios modelos-	163.793 000 990 44 92
1	Fijac. gato talonera puerta Clase C (W203) '00->'07	163.855 203 997 01 86
1	Fijac. gato talonera puerta Clase E (W210) '95->'02 y Clase S (W220) '99->'05	163.856 001 997 95 86
25	Fijac. parachoque Clase C (W203/W204), Clase E (W211) y W164	163.907 002 988 51 81
50	Remache fijac. panel puerta, tapizados interiores y otros usos -varios modelos-	163.926 000 990 22 92



U.E.	DESCRIPCION	Ref. Adaptable
100	Remache varios usos Mercedes (ver Ford, Opel, PSA, VAG)	162.373 000 990 29 92
50	Remache fijac. aletas y parachoques delantero y trasero Vito (W638), fijac. tapizados puerta lateral trasera y portón trasero Vito (W639) y otros usos -varios modelos- (ver Fiat, PSA, Renault, VAG)	162.424 638 990 04 92
50	Remache fijac. revestimientos interiores Mercedes (ver VAG)	162.505 001 994 41 45
50	Fijac. rejilla lavaparabrisas "torpedo" Vito (W639) y otros usos Mercedes CL, SL (ver PSA, VAG)	163.014 123 990 02 92
50	Fijac. pasoruada Sprinter '06 y otros usos clase C (W203), clase E (W211) (ver BMW, Mini, VAG)	163.044 000 990 54 92
25	Remache fijac. parachoques trasero Vito (W639), fijac. moldura lateral parte posterior Sprinter, fijac. tapizados interiores clase C (W203), otros usos CLK, ML, clase S (ver BMW, Mini, Volvo)	163.069 201 990 02 92
25	Remache fijac. varios usos Mercedes (ver Opel, Volvo)	163.198 000 990 45 29
25	Remache fij. pasoruada clase C (W204), CLK (W209), clase E (W212), ML (W164), fij. parachoque clase A (W169), clase B (W245), fij. talonera puerta ML, GL, W164 (ver Opel, VAG)	163.235 124 990 04 92
50	Remache fijac. tapizados interiores Sprinter	163.409 000 991 39 40
50	Remache fijac. parachoques delantero Vito (W638/639) (ver PSA, Renault)	163.487 638 990 15 92
25	Remache fijac. rejilla parabrisas («torpedo») Clase C '07-> (W204) (Eurocode 5364ASSSB) fijac. otros usos W123, W124, W126, W211, W219	163.640 123 990 05 92 126 990 03 92
25	Remache fijac. moldura talonera Clase C (W203), Clase E (W211), Clase s (W220)	163.780 001 990 01 92
25	Remache fijac. protectores bajos ML (W163/W164) GL, CL, Clase S y R (W221/W251)	163.924 163 990 02 92
50	Remache fijac. soporte radiador y otros usos -varios modelos-	163.925 123 990 00 92
50	Remache fijac. panel puerta, tapizados interiores y otros usos -varios modelos-	163.927 000 990 37 92



163.651

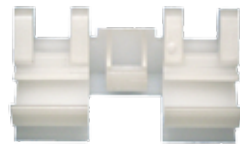

163.652



163.653



163.758



163.759



163.836



163.454



163.288



162.948



163.847



163.848



163.623



163.860



163.626



163.627



163.628



163.846

U.E.	DESCRIPCION		Ref. Adaptable
50	Fijac. parachoques trasero y revestimientos int. R50, R52, R53 y R56 (ver BMW, Ford, Opel, VAG)	162.948	16 13 1 176 747
50	Fijac. parachoques trasero R50, R52, R53 y R56 (ver BMW, Mercedes)	163.288	16 13 1 176 747
50	Fijac. pasoruadas R56 (ver BMW)	163.454	51 16 1 943 122
25	Fijac. moldura aletines pasoruada y parachoques R50, R52, R53, R56 y R57 ->08/10	163.623	07 13 1 480 418
10	Fijac. moldura pasoruada a capó R50, R52 y R53	163.626	07 13 7 036 159
25	Fijac. moldura talonera puerta R50, R53 y R56	163.627	07 13 7 073 915
25	Fijac. moldura talonera puerta R50, R52, R53 y R56	163.628	07 13 1 480 419
25	Fijac. moldura inferior parabrisas R50, R52, R53 (Eurocode 2440ASCHB)	163.651	07 13 1 490 537
25	Fijac. moldura inferior parabrisas R50, R52, R53 (Eurocode 2440ASCHB1B)	163.652	51 31 7 046 633
25	Fijac. moldura inferior parabrisas R50, R52, R53 (Eurocode 2440ASCHB2B)	163.653	51 31 7 111 933
10	Fijac. moldura cristal lateral trasero R50, R53	163.758	51 36 7 044 616
10	Fijac. moldura cristal lateral trasero R50, R53	163.759	51 36 7 044 615
25	Fijac. moldura lateral techo (parte delantera) R50, R53, 55 (Eurocode 2455ASCHD)	163.836	51 13 7 058 122
25	Fijac. moldura pasoruada trasero R50, R52 y R53	163.846	07 13 0 702 516
25	Fijac. soporte matrícula trasero R50, R52 y R53	163.847	51 18 8 242 692
25	Fijac. soporte matrícula trasero R50, R52, R53, R56, y R57 (ver BMW)	163.848	51 18 8 242 693
25	Fijac. moldura aletines pasoruada y parachoques Mini Cooper Cabrio R57 08/10->	163.860	07 13 2 757 821



163.823



163.636



163.624



163.625



163.826



163.864



163.629



163.845



163.727



163.750



163.752



163.843



163.754



163.753



161.420



163.849

Ø 6  
cabeza Ø 15



163.044

Ø 6  
cabeza Ø 20



163.045

Ø 8  
cabeza Ø 20



163.069

Ø 10



163.037

U.E.	DESCRIPCION	Ref. Adaptable
50	Fijac. tapizados interiores pilar D Mini Countryman R60 (ver BMW, Ford)	161.420 51 49 8 123 832
10	Fijac. pasoruada y talonera puerta R50, R52, R53, R55, R56, R57 y R60 (ver BMW y Rover)	163.037 07 13 0 702 966
50	Fijac. revest. interiores R50, R52, R53 y R56 (ver BMW, VAG)	163.044 51 11 1 908 077
50	Fijac. revest. interiores R50, R52, R53 y R56 (ver BMW, VAG)	163.045 51 11 8 174 185
25	Fijac. parachoques delantero R56 (ver BMW, Mercedes, Volvo)	163.069 51 47 1 911 992
25	Fijac. moldura pasoruada delantero R50, R52 y R53	163.624 07 13 7 036 160
10	Fijac. moldura aleta pasoruada trasero R50, R52 y R53	163.625 51 13 7 034 022
50	Fijac. moldura talonera puerta R50, R52, R53 y R56	163.629 51 71 1 496 621
25	Fijac. moldura lateral parabrisas R52	163.636 51 13 7 127 001
50	Fijac. moldura intermitente lateral Mini Countryman (R60) (ver PSA)	163.727 51 13 9 804 996
25	Fijac. panel puerta R50, R52, R53, R55, R56, R60, fijac. moldura parabrisas R58 (ver BMW)	163.750 51 41 8 224 768
25	Fijac. panel puerta R50, R52, R53 (ver BMW)	163.752 51 41 8 224 781
25	Fijac. mold. lateral parabrisas R50, R52, R53, R55, R56, R57, fijac. panel puerta trasero R55, fijac. moldura parabrisas R58 (ver BMW)	163.753 07 14 7 145 753
25	Fijac. tapizados maletero R50, R52, R53, R56 (ver Ford)	163.754 07 13 1 503 417
10	Fijac. agarradero exterior portón trasero R56 / R57 (ver BMW)	163.823 51 25 2 753 575
25	Fijac. moldura exterior pilar B Mini Countryman R60 (ver BMW)	163.826 51 33 7 140 714
50	Fijación tapizados interiores techo R50/53, fijación cubierta superior parabrisas R52, fijac. revestimientos interiores R55/56/60 (ver BMW)	163.843 51 43 7 001 491
50	Fijac. moldura ventana puertas R50, R52, R53 y R55	163.845 07 13 0 561 277
25	Fijac. spoiler trasero R56 (ver BMW)	163.849 07 17 7 141 218
25	Fijac. moldura adorno frontal capó R55, R56 y R57	163.864 51 13 2 754 667



161.715



161.772



161.774



161.783



161.785



190.378\*

\* (imagen 1/2 tamaño real)



190.067



190.066



190.068



190.065

U.E.	DESCRIPCION	Ref. Adaptable
10	Tornillo fijación protector compartimento motor R50, R52, R53 (ver BMW)	161.715 51 71 8 212 148
10	Tuerca fijación insonorizante motor R50, R53 (ver BMW, VAG)	161.772 51 71 8 212 164 07 14 6 981 767
50	Fijación varios usos R50, R52, R53, R55, R56, R57, R60 (ver BMW)	161.774 07 12 9 901 746 07 12 9 925 770
50	Fijación revestimientos puertas R55, R56, R57 (ver BMW)	161.783 51 41 2 756 212
25	Fijación embellecedor parachoques trasero Mini Countryman R60 (ver BMW)	161.785 07 14 7 054 461
2	Surtidor lavaparabrisas R50, R52 y R53	190.065 61 66 7 146 377
2	Surtidor lavaparabrisas calentable R50, R52 y R53	190.066 61 66 7 146 378
2	Surtidor delantero derecho lavaparabrisas calentable R55, R56, R57 y R60	190.067 61 66 2 756 194
2	Surtidor delantero izquierdo lavaparabrisas calentable R55, R56, R57 y R60	190.068 61 66 2 755 722
1	Bomba lavaparabrisas R55, R56, R57, R60 (ver Mercedes, VAG)	190.378 67 12 8 377 987



190.365\*



190.363\*

\* (imagen 1/2 tamaño real)



163.832



163.977



163.643



163.273

10 x 10  
Tornillo Ø 4,8



163.538

10 x 10  
Tornillo Ø 5,5



163.274

8,5 x 8,5  
Tornillo Ø 5,5



163.268



163.272



163.649



163.539



163.267



163.270



163.271



163.300



163.269



163.482

Ø 8  
cabeza Ø 20



163.069

U.E.	DESCRIPCION	Ref. Adaptable
10	Fijac. varios usos y modelos (ver BMW, Mercedes, Mini, Volvo)	163.069 M-820141
10	Fijac. moldura pasoruada Pajero, Montero	163.267 MB-115492
10	Taco fijac. tapizados y varios usos Mitsubishi - varios - (ver Nissan)	163.268 MU-480033
10	Fijac. parachoques, moldura pasoruada y tapizados Carisma, Colt, Galant, Space Runner	163.269 MB-253964
10	Fijac. parrilla radiador y moldura pasoruada Carisma, Space Star	163.270 MR-215510
10	Fijac. parrilla radiador, moldura pasoruada, parachoques Colt Lancer, Montero, Pajero	163.271 MR-288150
10	Fijac. tapizados Carisma, Colt Lancer, Space Runner	163.272 MB-344789
10	Fijac. moldura parabrisas Montero, Pajero	163.273 MB-313984
50	Taco fijac. tapizados Mitsubishi - varios -	163.274 M-293328
10	Fijac. varios usos y modelos Mitsubishi (ver Suzuki, Volvo)	163.300 MB-476821
10	Fijación pasoruada Montero, fijación rejilla radiador Montero/Pajero, fijación parachoques Galant, Space Runner (ver Honda, Nissan)	163.482 MR-328954
50	Taco fijac. tapizados Mitsubishi - varios -	163.538 MS-480002
10	Fijac. moldura pasoruada Mitsubishi - varios -	163.539 MB-138567
10	Fijac. moldura parabrisas Space Star	163.643 MR-447362
50	Fijac. moldura parabrisas Space Star	163.649 M-283083
10	Fijac. moldura parabrisas Colt '92->'02, Lancer '91->'00, Mirage (Eurocode 5641ASCHS)	163.832 MB-814154
10	Fijac. moldura parabrisas Colt '92->'02, Lancer '91->'00, Mirage (Eurocode 5642ASCHS)	163.977 MB-814152
1	Bomba lavaparabrisas -varios modelos- (ver Honda, Hyundai, Kia, Mazda, Subaru, Suzuki, Toyota)	190.363 MR-155254 MB-286961
1	Bomba lavaparabrisas Montero (ver Daewoo, Ford, Honda, Hyundai, Suzuki, Toyota)	190.365 MB-358361





190.384\*



190.388\*



176.213\*

\* (imagen 1/2 tamaño real)



163.480



163.615



163.156



163.904



163.157



163.158



163.279



7 x 7  
Tornillo Ø 3,5

162.817



8,5 x 8,5  
Tornillo Ø 4,8

163.520



8,5 x 8,5  
Tornillo Ø 5,5

163.484



8,5 x 8,5  
Tornillo Ø 5,5

163.268



163.120



163.155

U.E.	DESCRIPCION	Ref.	Adaptable
25	Taco fijac. varios usos - varios modelos - (ver VAG)	162.817	SS-06-0364A
10	Taco fijac. aletas Nissan Terrano II '96-> y varios usos Nissan	163.120	01553-02923
10	Clip fijac. parrilla radiador - varios modelos -	163.155	62318-0T001
25	Clip fijac. molduras pasoruada Patrol, Terrano, Terrano II, fijac. molduras laterales Terrano II, fijac. revest. portón trasero Almera Tino, Terrano II	163.156	01553-02903
10	Clip fijac. parachoques Serena	163.157	01553-01342
25	Clip fijac. parrilla radiador Almera, Micra, Primera, Terrano II	163.158	01553-05751
10	Fijac. tapizados y varios usos Nissan Micra, Montero, Pajero, Space Runner, Sunny (ver Mitsubishi)	163.268	01281-00231
10	Clip fijac. parrilla radiador Micra, Primera	163.279	26399-3J110
25	Fijac. varias capó Primera	163.480	01552-00661
50	Fijac. tapizados puerta X-Trail	163.484	62698-V7000 67898-U7400
10	Fijac. tapizados interiores - varios - (ver Honda, Mazda, Toyota)	163.520	01651-00481
10	Fijac. insonorizante capó Almera, Maxima, Micra '92, Micra '03	163.615	65846-30F00
25	Fijac. rejilla parabrisas "torpedo" Primera P11 y P12 '96-> (Eurocode 5981ASCS) y varios usos Micra '92->'02	163.904	66820-9F900
1	Regulador eléctrico faro Navara '05, Qashqai '06, Pathfinder '05, Primera '01	176.213	286056-AU300
1	Bomba lavaparabrisas Almera, Maxima, Patrol, Primera, Serena, Sunny, Teana '06, Vanete, X-Trail '01, 350Z	190.384	28920-50Y00
1	Bomba lavaparabrisas Almera Tino, Qashqai, Pathfinder, Terrano II (ver Dacia, PSA, Renault)	190.388	28920-BU010



U.E.	DESCRIPCION	Ref. Adaptable
50	Fijac. revestimientos interiores - varios modelos - (ver Ford)	162.910 01553-0801M
100	Fijac. tapizados interiores - varios modelos - (ver Mercedes, PSA, Renault)	162.934 SS-07-0069A
50	Fijac. parachoques Micra (ver Dacia, Opel, Renault)	163.088 01515-00QAB
10	Fijac. parachoques y otros usos Almera Tino, Note, Primera, Teana, Tiida, X-Trail (ver PSA, Toyota)	163.166 01553-09611
10	Fijac. bajos carrocería Nissan Qashqai, fijac. parachoques Nissan - varios - (ver Subaru)	163.276 01553-09241
10	Fijac. parachoques, molduras pasoruada y tapizados interiores Almera, Almera Tino, Micra '03->, Primera P10 ('90->'96) y P11 ('96->'02), Serena, Sunny, Terrano II (ver Honda, Volvo)	163.277 63848-01G00
10	Fijac. parachoques, molduras pasoruada y parrilla radiador Galant, Micra, Montero, Pajero, Space Runner, Sunny	163.278 63854-01A00
10	Fijac. tapizados interiores - varios modelos -	163.280 01553-00051
50	Remache fijación varios usos (ver VAG)	163.329
25	Fijac. tapizados interiores Primastar (ver Opel, Renault)	163.385
25	Fijac. soporte parachoques Micra	163.481 01553-01A50
10	Fijac. pasoruada Qashqai, X-Trail, fijac. parachoques, aletas, rejilla calandra Qashqai (ver Honda, Mitsubishi)	163.482 01553-09321
10	Fijac. panel puerta Primera	163.483 01553-08101
10	Fijac. parachoques Almera '00, Almera Tino, Micra, Murano, Navara, Note, Pathfinder, Patrol, Primera, Qashqai, Sunny, Teana, Terrano, Tiida, X-Trail, 350Z (ver Honda)	163.802 01553-09321
10	Fijac. panel puerta y tapizados interiores Almera, Almera Tino, Maxima, Micra, Navara, Qashqai, Patrol, Primera, Sunny, Terrano, X-Trail, 350Z	163.806 80999-VE000 01553-08371 01553-07381
10	Fijac. panel puerta y tapizados interiores Micra C+C '05->, Murano, Primera '01->, Qashqai, Sunny, Teana, X-Trail, 350Z	163.807 01553-07111 84953-AU100
10	Fijac. parachoques Sunny, Terrano II, X-Trail '07->	163.815 01553-06721

Ø 5 x 22  
arandela Ø 16



**161.750**

Ø 6 x 20



**161.721**

Ø M6 x 20  
arandela Ø 18



**161.727**

Ø 4,8 x 15  
arandela Ø 15



**161.473**

Ø 4,8 x 18  
arandela Ø 15



**161.474**

Ø 5,5 x 19  
arandela Ø 18



**162.555**

Ø 5,5 x 19  
arandela Ø 22



**161.742**

Ø 6,3 x 19  
arandela Ø 18



**162.556**

Ø 6,3 x 19  
arandela Ø 22



**161.743**

Ø 2,4 x 5



**162.362**



**161.781**



**162.266**

U.E.	DESCRIPCION	Ref. Adaptable
50	Tornillo Ø 4,8 x 15 (aro Ø 15), varios usos (ver BMW, Ford, Mercedes, PSA, VAG)	<b>161.473</b>
50	Tornillo Ø 4,8 x 18 (aro Ø 15), varios usos (ver BMW, Ford, Mercedes, PSA, VAG)	<b>161.474</b> 20 20 005 11071511
25	Tornillo Ø 6 x 20, varios usos (ver PSA, Renault)	<b>161.721</b>
25	Tornillo Ø 6 x 20 (aro Ø 18), varios usos (ver Dacia, Renault)	<b>161.727</b>
50	Tornillo Ø 5,5 x 19 (aro Ø 22), sujeción guardabarros (ver BMW, Ford, Mercedes, VAG)	<b>161.742</b>
50	Tornillo Ø 6,3 x 19 (aro Ø 22), sujeción guardabarros (ver BMW, Ford, Mercedes, VAG)	<b>161.743</b>
25	Tornillo Ø 5 x 22 (aro Ø 16), varios usos (ver Dacia, Renault)	<b>161.750</b>
25	Clip fijac. aletas delanteras Astra H, Corsa D '07->	<b>161.781</b> 11 10 936 13154960
25	Fijac. anagramas modelos (ver Ford)	<b>162.266</b> 01 74 751
50	Remache Ø 2,4 x 5, fijac. varias aplicaciones Ascona, Calibra, Corsa A y B, Kadett, Vectra A y B (ver Fiat, Ford, PSA, Renault, VAG)	<b>162.362</b> 01 64 361 90033713
50	Tornillo Ø 5,5 x 19 (aro Ø 18), sujeción guardabarros (ver Ford, VAG)	<b>162.555</b> 20 22 107 20 26 706 11093351
50	Tornillo Ø 6,3 x 19 (aro Ø 18), sujeción guardabarros (ver BMW, Ford, Mercedes, VAG)	<b>162.556</b> 20 22 203



161.427

161.745

161.704

161.465

161.756



162.711

162.712



181.417\*

162.874

163.057

162.918

\* (imagen NO a tamaño real)

U.E.	DESCRIPCION	Ref. Adaptable
50	Clip fijac. parachoques Corsa C, Meriva, fijac. panel toma aire Corsa B (ver BMW, Renault, VAG)	161.427 20 72 082 11090592
50	Clip fijac. frontal Corsa, Kadett, Astra (ver Ford, VAG)	161.465 207217563
50	Clip fijac. varios usos Opel - varios modelos - (ver BMW, Ford)	161.704 20 72 077
25	Clip fijac. placa matrícula Opel Agila, Ascosa, Astra F, Calibra, Corsa A, B y C, Kadett, Signum, Vectra A, B y C	161.745 11 88 303 90053225
25	Clip fijac. aletas Astra F, G y H, Corsa B y D '07->, Vectra B y C, Signum, Zafira A y B	161.756 20 72 001 11094002
25	Tuerca con aro móvil, varios usos (ver Ford, PSA, Renault, VAG)	162.711 20 64 162 11095121
25	Tuerca con aro móvil, varios usos (ver Ford, PSA, Renault, VAG)	162.712 20 66 027 11074603
10	Fijac. mando calefacción Ascona, Astra F, Calibra, Omega A, Senator B, Vectra A	162.874 18 24 622
10	Fijac. cableado Astra F, Calibra, Omega, Senator, Vectra A	162.918 12 88 548 90230571
10	Fijac. varilla capó Astra G, Calibra, Corsa'94, Omega A, Vectra A (ver Mercedes)	163.057 11 80 216 11 80 411
-	Tirante bandeja posterior Opel Corsa B (long.total 285 mm.)	181.417



190.364\*



190.368\*



190.371\*



190.372\*



190.373\*



190.389\*

\* (imagen 1/2 tamaño real)



190.010



190.011



190.012



190.013

U.E.	DESCRIPCION	Ref. Adaptable
5	Surtidor lavaparabrisas Ascona, Corsa A	190.010 14 51 166 90087621
5	Surtidor lavaparabrisas Calibra, Corsa B, Omega	190.011 14 51 181 90356178
5	Surtidor lavaparabrisas Kadett	190.012 14 51 174 9197915
5	Surtidor lavaparabrisas Astra F	190.013 14 51 183 90360289
1	Bomba lavaparabrisas Astra F, Corsa A y B, Kadett, Omega B, Vectra A (ver Fiat)	190.364 14 50 175 90492357
1	Bomba lavaparabrisas Astra F (ver Ford, VAG)	190.368
1	Bomba lavaparabrisas Ascona, Astra F, Corsa A y B, Kadett, Omega, Senator, Vectra A (ver Mercedes, VAG)	190.371 14 50 156 90045820
1	Bomba lavaparabrisas Agila, Astra G y H, Corsa B, C y D, Meriva, Omega, Signum, Tigra, Vectra B y C, Zafira A y B (ver VAG)	190.372 14 50 173 14 50 185 90585762
1	Bomba lavaparabrisas Astra G y H (sedán), Combo, Corsa C, Omega, Tibra B, Vectra B y C (sedán), Zafira	190.373 14 50 184 90585761
1	Bomba lavaparabrisas -varios modelos-	190.389



162.937



163.852



163.431

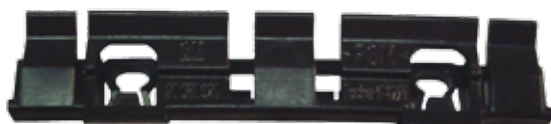

163.345



163.901



163.851



163.732

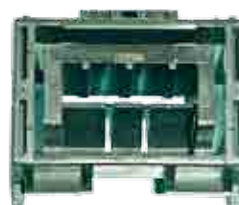

162.938



163.642



163.425



163.800

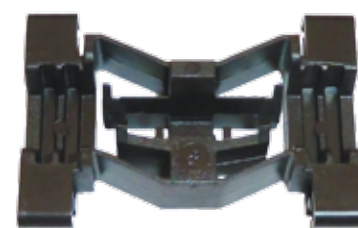

163.930

U.E.	DESCRIPCION	Ref. Adaptable
10	Fijac. moldura parabrisas Astra G (parte delantera) (Eurocode 6284ASCHS)	162.937 01 88 550 01 88 574 90587517
10	Fijac. moldura techo-parabrisas (parte delantera y final) Astra G (Eurocode 6284ASCH1T)	162.938 01 88 577 9131114
10	Fijac. molduras laterales parabrisas Zafira A '99->'04 (Eurocode 6283ASCH / 6283ASCVS)	163.345 01 88 581 90580920
10	Base soporte parabrisas Movano (Eurocode 7247ASCV) (ver Fiat, Renault)	163.425 45 00 292 44 15 522 93181418
50	Fijac. moldura rejilla lavaparabrisas "torpedo" Astra H '04->, Zafira B '05-> (Eurocode 6302ASCHB)	163.431 51 04 988 13155024
10	Fijac. moldura techo-parabrisas (parte central) Astra G Coupé, Sedán y Familiar	163.642 01 88 580 9131181
10	Fijac. moldura lateral parabrisas Astra G (Eurocode 6284ASCHD)	163.732 01 88 573 90562265
10	Fijac. moldura lateral techo Astra H, Zafira B	163.800 01 87 925 73 51 804 93348922
10	Fijac. moldura techo-parabrisas Zafira A '99->'04	163.851 01 88 582 90580928
10	Fijac. moldura inferior parabrisas Agila '00->'07 y '08-> (Eurocode 6291ASCV) (ver Fiat, Suzuki)	163.852 47 07 662 9216439
10	Fijac. moldura techo Meriva '03->, Signum, Vectra C	163.901 01 87 918 9185662
10	Fijac. moldura techo Corsa C '00->'06	163.930 01 88 551 9114735



162.319



162.411



162.324

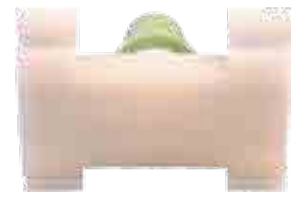

162.944



163.675\*



163.676\*

\* (imagen 1/2 tamaño real)



163.798

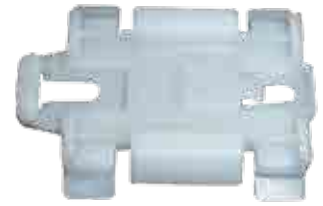

163.799



163.149



163.430



163.433



163.435



163.876



163.899



163.432

U.E.	DESCRIPCION		Ref. Adaptable
10	Fijac. moldura lateral puerta y aletas Ascona '82, Corsa A, Kadett E	162.319	01 74 843 90119995
10	Fijac. molduras - modelos antiguos -	162.324	
25	Fijac. moldura Corsa	162.411	01 74 846
10	Fijac. molduras laterales traseras Astra '98, 3 puertas (ver BMW)	162.944	01 72 017 90590995
25	Fijac. moldura lateral puerta Astra G ('98->'03), 3 y 5 puertas	163.149	01 72 923 90590944
25	Fijac. moldura lateral puerta Astra G ('98->'03)	163.430	01 72 018 90590996
25	Fijac. molduras laterales Vectra B	163.432	01 71 964 90508326
25	Fijac. molduras laterales Vectra B	163.433	01 71 965 90508327
25	Fijac. panel puerta Corsa C, Combo, fijac. tapizados interiores Astra G, Meriva, Zafira A	163.435	22 28 838 9133594
10	Fijac. moldura portón trasero Zafira	163.675	01 74 836 90588746
10	Fijac. moldura portón trasero Zafira	163.676	01 74 845 90588747
10	Fijac. moldura talonera puerta Corsa A y B, Kadett E, Vectra A	163.798	01 64 978 90196277
10	Fijac. moldura portón trasero y luneta trasera Vectra B Familiar, fijac. moldura lateral Omega A	163.799	01 74 853 90376175
25	Fijac. moldura parabrisas Combo, Meriva, fij. tapiz. interiores Corsa D, Insignia, Signum, Vectra C, Zafira B, fijac. talonera puerta Corsa C y D, Meriva, Vectra C, Signum, Zafira B (ver PSA, Renault)	163.876	12 22 141 24405740
25	Fijac. moldura techo Zafira B, fijac. revestimientos interiores pilar A y entrada a puerta Astra H, Corsa C y D, Insignia, Meriva, Signum, Vectra C, Zafira B (Eurocode 6290ASCH)	163.899	22 28 839 24405739



U.E.	DESCRIPCION	Ref. Adaptable
50	Fijac. panel puerta Astra F, Ascona, Corsa A, Kadett	<b>162.410</b> 22 40 582 22 40 587 90321121
50	Fijac. panel puerta Kadett	<b>162.630</b>
50	Fijac. moldura lateral Vivaro (componente del kit OEM: 44 09 963 / 93160023) (ver Renault)	<b>162.824</b>
25	Fijac. rejilla parabrisas "torpedo" y tapizados interiores Opel Vivaro (Eurocode 6300ASCVB) (ver Renault)	<b>162.826</b> 44 14 667 91169651
25	Fijac. revestimiento interior traseros Vectra A y B	<b>162.853</b> 23 40 950 90269693
50	Fijac. moldura lateral Vivaro (ver Fiat, Renault)	<b>162.992</b>
50	Fijac. moldura lateral Vivaro (componente del kit Opel Vivaro OEM: 44 09 963 / 93160023) (ver Fiat, Renault)	<b>162.993</b> 44 12 053 91169650
25	Fijac. moldura lateral Vivaro (componente del kit OEM: 44 09 963 / 93160023) (ver Renault)	<b>162.994</b>
50	Fijac. panel puerta Corsa C, Corsa D ('07->), Astra G, Tigra	<b>163.012</b> 23 45 957 90321122
25	Fijac. panel puerta Astra F, Vectra C	<b>163.064</b> 23 45 959 90457899
50	Fijac. moldura lateral puerta, talonera puerta y aletas Astra G, Corsa B, Signum, Vectra B y C, Zafira A	<b>163.065</b> 01 74 864 01 74 854 90481595
25	Fijac. panel puerta y tapizados interiores Movano, Vivaro (ver Renault)	<b>163.141</b> 44 30 858 44 14 720 93161475
50	Fijac. moldura pasorueda delantero Corsa C y Combo	<b>163.332</b> 01 22 920 9114743
25	Fijac. molduras laterales Signum, Vectra C	<b>163.434</b> 01 72 985 9177065
50	Fijac. tapizados puerta Astra H, Corsa C, Meriva, Signum, Vectra B y C, Zafira B, fijac. tapizados interiores Astra G, Corsa B	<b>163.614</b> 01 49 910 90560163
50	Fijac. tapizados interiores pilar central Astra G, Zafira A	<b>163.679</b> ● 01 22 915 90589557
50	Fijac. tapizados interiores Astra F	<b>163.680</b> ● 01 49 907 90414663
50	Fijac. moldura lateral puerta, talonera puerta y aletas Corsa B, Signum, Omega B, Vectra B, Zafira A	<b>163.911</b> ● 01 74 611 01 29 943 90580707





173.197



178.098



162.345



162.281



162.412



162.809

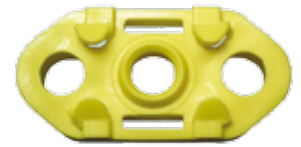

163.561 - Dcho./Izdo



163.559 - Dcho./Izdo



163.560 - Dcho./Izdo



163.562 - Dcho.  
163.563 - Izdo.

U.E.	DESCRIPCION		Ref. Adaptable
25	Fijac. faro Frontera, Kadett, Omega, Senator	162.281	12 18 601 90181010
25	Fijac. faro Ascona C	162.345	12 16 904 90123504
25	Fijac. faro Corsa A	162.412	12 17 801 90321482
25	Fijac. faro Corsa B '93, Tigra	162.809	12 18 604 90386374
1	Soporte cristal elevallunas derecho e izquierdo Corsa	163.559	
1	Soporte cristal elevallunas derecho e izquierdo Astra, Vectra	163.560	
10	Patín cristal elevallunas derecho e izquierdo Astra, Vectra	163.561	
1	Soporte cristal elevallunas derecho Meriva	163.562	
1	Soporte cristal elevallunas izquierdo Meriva	163.563	
1	Regulador eléctrico faro Astra H, Insignia '09, Signum, Vectra C '02->'05 (ver VAG)	173.197	62 07 109 13142042
1	Regulador eléctrico faro Corsa D, Meriva, Signum, Tigra '04, Vectra C '05-> (ver VAG)	178.098	12 07 203 13129840



U.E.	DESCRIPCION	Ref. Adaptable
100	Botón fijac. rejilla calandra Zafira B '05, fijac tapizados interiores Astra F, Corsa A y B, Kadett, Omega B, Vectra A y C (Negro) (ver PSA, Renault)	162.221 23 46 824 23 38 961 90283614
100	Botón fijac. panel y tapicería todos los modelos (Gris) (ver PSA, Renault)	162.222 22 26 953 90328384
50	Botón fijac. panel y tapicería todos los modelos (Blanco) (ver PSA, Renault)	162.320
50	Fijac. deflector aire Signum, Vectra C (ver BMW, Ford, VAG)	162.782 22 07 713 90082231
50	Botón + boca fijación junta goma puertas y techo Astra H, Corsa D, Meriva, Zafira A y B (ver Ford, VAG)	162.844 01 57 979 90579619
50	Botón fijac. tapizados interiores (color negro)	162.968
50	Fijación aislante capó Agila, Astra F, G y H, Corsa A, B, C y D, Kadett, Meriva, Omega, Signum, Vectra A, B y C, Zafira A y B	162.970 11 62 488 90355604
25	Fijac. tapizados interiores Astra F, G y H, Calibra, Kadett, Omega, Vectra A y B, Zafira B	163.066 22 08 843 90218614
25	Tapón agujeros Ø 6,5 Ascona, Astra F y G, Calibra, Corsa A, Kadett, Omega, Senator	163.079 11 62 484 90040750
25	Clip fijac. parrilla radiador Campo, Frontera, Monterrey (ver Honda, Mazda, Toyota)	163.159 13 20 703 94218027
25	Fijac. tapizados interiores Vivaro (ver Nissan, Renault)	163.385
50	Fijac. junta puerta Astra G, Insignia, Zafira A	163.436 01 57 905 90562273
50	Fijac. moldura pasoruada Astra F, Kadett, Vectra A, fijac. panel radiador Corsa B	163.678 09 12 466 90335715
50	Fijac. tapiz. alfombras piso Astra G, Calibra, Combo, Corsa A, Kadett E, Omega A y B, Vectra A y B, fijac. ajuste respaldo Agila, Astra H, Corsa C, Meriva, Zafira B	163.902 22 40 861 90022049
50	Fijac. insonorizante capó Astra G, Combo, Corsa B y C, Insignia, Tigra B, Vectra B y C, Zafira A	163.919 11 62 742 13265959



163.897



163.898

tornillo Ø 5



163.677

tornillo Ø 5



163.150

tornillo Ø 5



163.437

tornillo Ø 5



163.438

tornillo Ø 5,5



162.974

tornillo Ø 5,5



163.916

tornillo Ø 6



162.948

7 x 14  
Tornillo Ø 3,9



163.222

8 x 8  
Tornillo Ø 4



162.903

8,2 x 8,2  
Tornillo Ø 4,2



163.439

8 x 10  
Tornillo Ø 5,5



163.039

U.E.	DESCRIPCION	Ref. Adaptable
25	Taco fijación parrilla radiador Astra H (ver Renault)	162.903 13 20 925 13240067
50	Fijac. (tornillo Ø 6) aleta delantera Corsa B, Omega, Vectra A, fijac. bajos carroceria Corsa A (ver BMW, Ford, Mini, V.A.G.)	162.948 1 80 940 90127883
25	Fijac. placas matrículas Opel Astra F, Calibra, Kadett, Omega, Senator	162.974 11 90 365 90139015
25	Fijac. revestimientos parachoques Astra F, G y H, Corsa B, Calibra, Omega, Signum, Vectra B y C, Zafira A	163.039 14 06 984 90482706
50	Fijación (tornillo Ø 5) guardabarros y pasoruada Astra G, Corsa B y C, Zafira B, fijac. pasoruada Meriva y fijac. moldura maletero Astra H	163.150 01 71 953 90377951
25	Taco fijac. aleta y moldura lateral puerta Opel Movano (ver Dacia, Fiat, Opel, PSA)	163.222 45 01 607 9161907
50	Fijac. (tornillo Ø 5) revestimientos interiores Astra F, G y H, Calibra, Corsa A, B, C y D, Meriva, Insignia, Signum, Vectra B y C, Zafira A y B	163.437 01 80 942 90413589
50	Fijac. (tornillo Ø 5) revestimientos inter. Astra G y H, Corsa B y C, Combo, Meriva, Omega, Tigra, Zafira	163.438 01 71 953 90377951
50	Taco fijac. piloto trasero Astra H, fijac. faro delantero Astra F, Calibra, Omega, Senator, Vectra A, fijac. rejilla radiador Corsa B, Combo (ver Ford)	163.439 12 16 957 90230960
50	Fijación moldura talonera puerta Vectra B, fijación tapizados interiores Meriva, Combo fij. faro delantero Corsa D,	163.677 08 17 950 90287467
50	Fijac. pasoruada Corsa C, fijac. parachoque Vectra B, Zafira A, fijac. tapizados y otros usos interiores Astra G y H, Meriva, Omega B, fijac. faro antiniebla Corsa C, Meriva, Omega B, Vectra B, Zafira A	163.897 12 35 884 24417039
50	Fijac. pasoruada y parachoques Astra H, Corsa D, Insignia, Meriva '03->, Signum, Vectra C, Zafira B, fijac. antiniebla delantero Astra H, Insignia, Vectra C, Zafira B, fijac. antiniebla trasero Corsa C	163.898 14 04 969 24449408
25	Fijac. placa matrícula trasera Opel Astra F, Calibra, Corsa A, Euromidi, Frontera A, Kadett E, Omega A, Vectra A	163.916 11 90 970 90053803

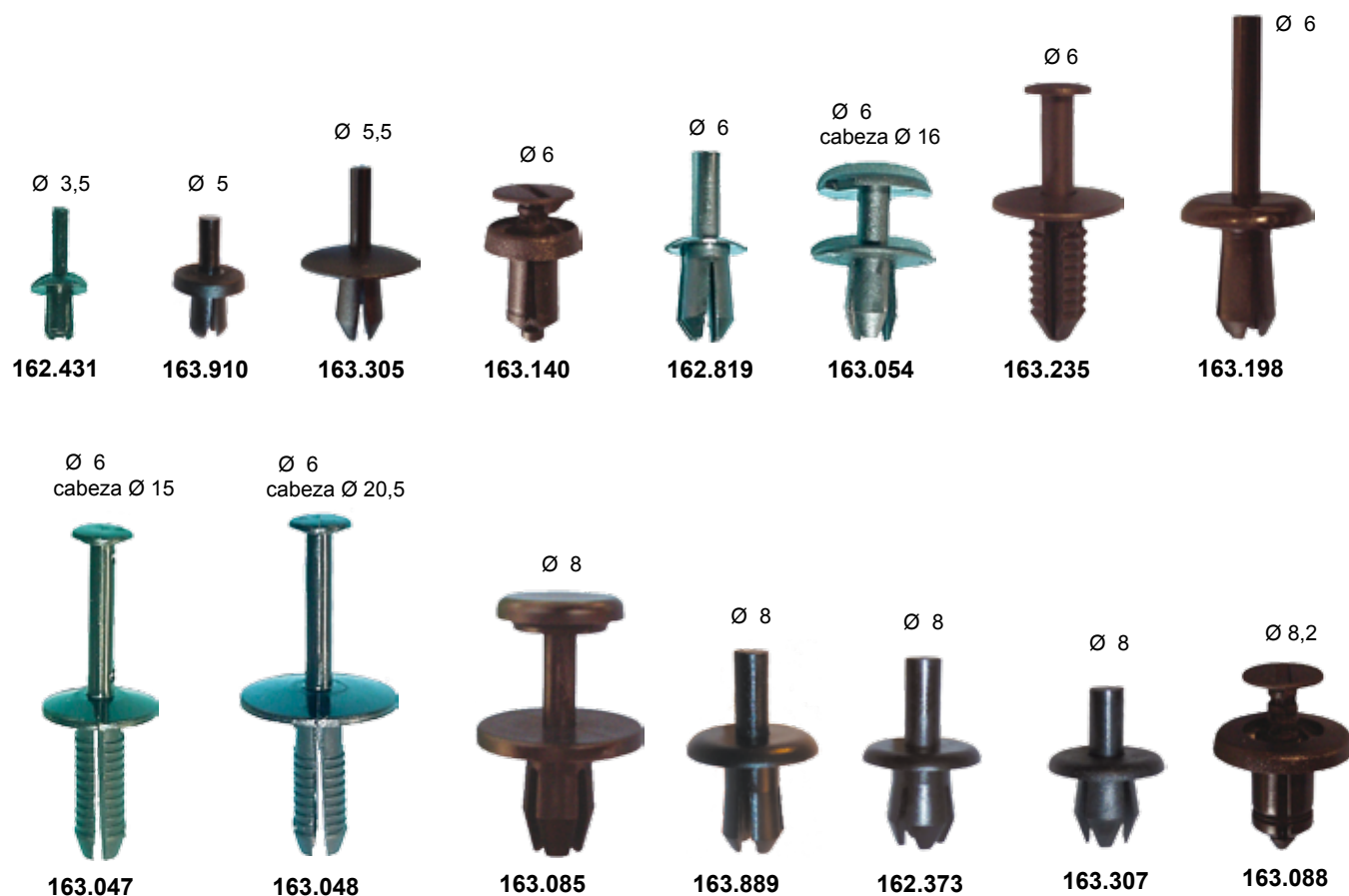

U.E.	DESCRIPCION	Ref.	Adaptable
100	Fijac. parachoques, spoiler y pasoruada Ascona, Astra H, Calibra, Corsa C y D, Meriva, Insignia, Signum, Vectra A y C, Zafira B (ver Ford, Mercedes, PSA, VAG)	162.373	11 04 880 90087290
100	Fijac. varios usos (ver BMW, PSA, VAG)	162.431	
50	Fijac. molduras parachoques y fijac. pasoruadas Astra F, Calibra, Corsa A y B, Kadett, Omega, Vectra A (ver Renault)	162.819	17 19 242 90058826
50	Fijac. parachoques trasero Astra H, Combo, Meriva, Insignia, fijac. parachoques delantero Astra F (ver BMW)	163.047	14 00 804 90414659
50	Fijac. parachoques delantero y trasero Astra G y H, Corsa C, Meriva, Signum, Tigra, Vectra B y C, Zafira A y B	163.048	14 00 806 90508809
50	Fijac. parachoques, pasoruada y spoiler Astra H, Signum, Vectra C, Zafira A y B, fijac. revestim. interiores Astra G y H, Corsa D '07	163.054	14 06 925 9130754
25	Fijac. panel trasero Corsa D, Vectra C (ver PSA)	163.085	18 10 850 90379945
50	Fijac. rejilla calandra Opel Movano B, fijac. soporte bandeja trasera Vivaro (ver Renault)	163.088	44 13 420 91169793
50	Fijac. rejilla parabrisas "torpedo" Vivaro (Eurocode 6300ASCVBK) (ver Dacia, Fiat, Nissan, Renault)	163.140	44 14 666 91169621
25	Fijac. varios usos Opel Frontera, Euromidi (ver Mercedes, Volvo)	163.198	11 44 811 90328832 94031590
25	Fijac. varios usos (ver Mercedes, VAG)	163.235	
50	Fijac. parachoques Astra G, Omega B, Vectra B, Zafira A, fijac. bajos carroceria Corsa A, Vectra A (ver Mercedes, VAG, Volvo)	163.305	23 17 703 90116376
100	Fijac. moldura pasoruada Astra H, Corsa B, C y D, Calibra, Meriva, Signum, Tigra B, Zafira B (ver Daewoo)	163.307	17 19 245 90138810
50	Fijac. parachoques Vectra C, Zafira B '05->, fijac. moldura pasoruada Astra F, G y H, Corsa D, Vectra B	163.889	11 04 882 11 04 881 90450482
50	Fijac. tapizados interiores Astra H, Zafira B '05->	163.910	22 65 571 90467391

# P.S.A. (PEUGEOT / CITROEN)

Ø 4,5 x 19  
arandela Ø 12



161.760

Ø 4,5 x 19  
arandela Ø 16



161.761

Ø 4,8 x 15  
arandela Ø 15



161.473

Ø 4,8 x 18  
arandela Ø 15



161.474

Ø 6 x 20



161.721

Ø M6 x 18  
arandela Ø 18



161.730

Ø M6 x 25  
arandela Ø 18



161.723

Ø M6 x 19



161.486

Ø M6 x 20



161.722

Ø 2,4 x 5



162.362

Ø 4,8 x 10



161.606

Ø 7,5 x 28

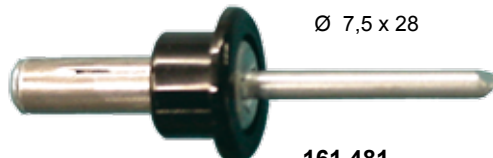

161.481

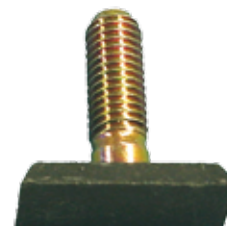

162.435

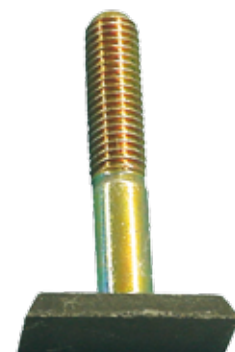

162.436

U.E.	DESCRIPCION	Ref. Adaptable	
50	Tornillo Ø 4,8 x 18 (aro Ø 15), varios usos (ver varias marcas)	161.473	
50	Tornillo Ø 4,8 x 18 (aro Ø 15), varios usos (ver varias marcas)	161.474	
10	Remache Ø 7,5 x 28, fijac. cristal posterior C4, C4 Picasso, C5 '04-'08, P-206, Expert 3	161.481	6973.A4
10	Tornillo fijac. parachoques C4, C5, C8, Jumpy, P-1007, P-206, P-307, P-307 Restyling, P-807, Expert -todos-, aletas traseras C5, P-407, fijac. faro Berlingo, Partner (ver VAG)	161.486	7427.23
100	Remache fijac. parachoque, elevelunas y revestimientos interiores -varios modelos-, fijac. rejilla parabrisas C4 (Eurocode 2732ASSHS)	161.606	6973.05
25	Tornillo Ø 6 x 20, fijac. parachoques delantero P-307 Restyling, y trasero P-407 y varios usos C1, C2, C3, C4, C5, Berlingo, DS3, Jumpy, Nemo, Xsara, Xsara Picasso, P-107, P-207, P-308, P-406, P-508, P-807, P-1007, P-3008, P-5008, Bipper, Expert, Partner (ver Opel, Renault)	161.721	6924.C1
25	Tornillo Ø 6 x 20, fijac. parachoques Berlingo, C4, C5, Jumpy, P-1007, P-206, P-307, Expert, Partner, fijac. cerraduras C2, C4, Evasion, Xsara, P-207, P-307 Restyling, P-407, fijac. aletas C4 '10->, P-3008, P-5008	161.722	7427.23
25	Tornillo Ø 6 x 23 (aro Ø 18), fijac. aletas, parachoques y otros usos Berlingo, C2, C3, C4, C5, Xsara Picasso, P-106, P-106, P-306, P-308, P-406, P-407, P-607, P-1007, Partner (ver Fiat)	161.723	6922.H3
25	Tornillo Ø 6 x 18 (aro Ø 18), fijac. aletas, parachoques y otros usos Berlingo, C2, C3, C4, C5, Jumper, Jumpy, Xsara Picasso, P-106, P-106, P-306, P-308, P-406, P-407, P-607, P-1007, Boxer, Expert, Partner	161.730	6922.54
25	Tornillo Ø 4,5 x 19 (aro Ø 12), fijac. plásticas varias (ver Fiat)	161.760	
25	Tornillo Ø 4,5 x 19 (aro Ø 16), fijac. parachoque, aletas y otros usos C2, C3, C4, C5, C8, Berlingo, Jumpy, Xantia, Xsara Picasso, P-206, P-207, P-307, P-308, P-407, P-508, P-3008, P-5008, Expert, Partner	161.761	6925.N0
50	Remache Ø 2,4 x 5, fijac. molduras P-205, varios Citroen (ver Fiat, Ford, Opel, Renault, V.A.G.)	162.362	
5	Tornillo fijac. parachoques P-205 (corto)	162.435	7429.47
5	Tornillo fijac. parachoques P-205 (largo)	162.436	7429.48



162.375

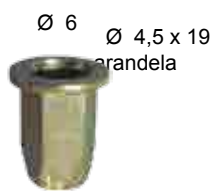

162.439



161.496



162.442

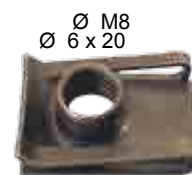

161.499



162.465



162.711



162.712



161.428



162.688



161.720



163.375



161.718



161.719



161.767



163.724



163.725

U.E.	DESCRIPCION	Ref. Adaptable
25	Muelle fijac. manecilla elevallunas C-15	161.428 75 429 475
50	Clip fijac. varios usos P.S.A. (ver Renault)	161.496
50	Clip fijac. talonera puerta P-306, P-605 (ver Ford, Renault)	161.499
50	Tornillo fijación protector motor/cárter y fijac. aletas y parachoques Berlingo, C2, C3, C4, C5, C8, Jumpy, P-206, P-207, P-807, P-1007, Expert, Partner	161.718 7030.16
50	Fijac. protector motor/cárter y fijac. aletas y parachoques Berlingo, C2, C3, C4, C5, C8, Jumpy, P-206, P-207, P-406, P-407, P-508, P-807, Expert, Partner	161.719 7030.18
50	Fijac. logotipos y seguro fijac. bisagra puertas Berlingo '09, C2, C3, C4, C5, Jumpy III, P-307, P-308, P-407, Partner '09, Expert III	161.720 9044.44
25	Fijac. protección bajos carrocería C5 '04 y '08->, C6, P-407, fijac. absorbedor parachoques delantero P-207	161.767 7030.19
25	Tuerca especial redonda varios usos (Ø 6) (ver Ford, Renault)	162.375
25	Boca metálica para fijaciones puerta P-205, P-306, P-309 (ver Fiat)	162.439 96 004 002 80
50	Clip fijac. pasoruedas ZX, Peugeot (ver Fiat, Renault, VAG)	162.442
50	Fijac. (Ø 6) varios usos (ver Fiat, Ford, Renault)	162.465
10	Fijac. moldura portón P-205	162.688 8742.19
25	Tuerca con aro móvil (Ø 6), varios usos (ver Ford, Opel, Renault, VAG)	162.711
25	Tuerca con aro móvil (Ø 8), varios usos (ver Ford, Opel, Renault, VAG)	162.712
50	Junta plástica fijac. protectores motor Evasion, Jumpy I y II, Xsara II, P-806, P-807, Expert I y II, fijac. parachoques C5 '04 y C8	163.375 7030.17
25	Fij. protector bajos carrocería Berlingo '96->'08, Xsara, Xsara Picasso, ZX, P-306, Partner '96->'08	163.724 6990.81
25	Fij. protector bajos carrocería Berlingo '96->'08, Xsara, Xsara Picasso, ZX, P-306, Partner '96->'08, fij. plancha bajo salpicadero AX, Xantia I y II, P-206 (monta junto con 163.724)	163.725 8220.EF

# P.S.A. (PEUGEOT / CITROEN)



163.729



163.885



163.888



162.814



163.323



163.869



163.728



163.723



190.025



190.026



190.034



190.035



190.041



190.042



190.043



190.045



190.057

U.E.	DESCRIPCION	Ref.	Adaptable
25	Fijac. varilla capó AX, C3, C4, C-15, Evasion, Saxo, P-106, P-306	162.814	6992.P3
25	Fijac. varilla capó Xsara Picasso	163.323	6993.A1
25	Fijac. varilla capó C3 '09->, C3 Picasso, DS3, P-207	163.723	7950.59
25	Fijac. varilla capó Berlingo '96->'02, C4 Picasso, ZX, P-307, Partner '96->'02	163.728	6997.A9
10	Fijac. varilla capó Berlingo '08->, C3 ->'08, C3 Pluriel, C4 ->'10, C4 Picasso, P-3008, P-5008, Partner '08->	163.729	7928.33
25	Fijac. varilla capó C4 '10->, P-206, P-308	163.869	7928.39
10	Fijac. varilla capó Evasion, Jumpy I y II, Expert I y II (ver Renault)	163.885	6995.X2
10	Fijac. varilla capó C3 Picasso, C8, Jumpy III, Xantia, P-206, P-207, P-307, P-807, Expert III	163.888	7928.31
5	Surtidor lavaparabrisas Saxo, P-106, P-205, P-306, P-309	190.025	6438.71
5	Surtidor lavaparabrisas Berlingo, Xantia, ZX, Partner	190.026	6438.A0 96084939
5	Surtidor lavaparabrisas Xsara Picasso	190.034	6438.F1
5	Surtidor lavaparabrisas P-406, P-605	190.035	6438.89
5	Surtidor lavaparabrisas C1, P-107 (ver Toyota)	190.041	6405.W3
5	Surtidor lavaparabrisas C4, P-308	190.042	6438.P4
2	Surtidor luneta trasera Saxo	190.043	6438.97
2	Surtidor luneta trasera Xsara Picasso	190.045	6438.F2
2	Surtidor luneta trasera P-106, P-306	190.057	6438.67



190.357\*



190.358\*



190.360\*



190.361\*



190.376\*

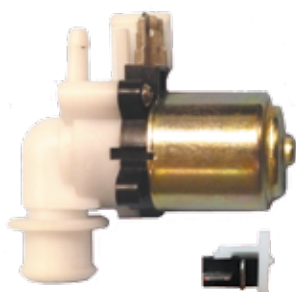

190.383\*



190.385\*



190.388\*

\* (imagen 1/2 tamaño real)

U.E.	DESCRIPCION		Ref. Adaptable
1	Bomba lavaparabrisas AX, BX, C-15, P-106, P-205, P-305, P-309, P-405	190.357	6434.46 6434.66
1	Bomba lavaparabrisas AX, Berlingo, Jumpy I y II, Xantia, XM, ZX, P-106, P-206, P-306, P-406, P-605, Expert I y II, Partner (ver Fiat)	190.358	6434.58
1	Bomba lavaparabrisas AX, Berlingo, Evasion, Saxo, Xantia, Xsara, ZX, P-106, P-206, P-306, P-406, P-806, Partner (ver Fiat)	190.360	6434.60
1	Bomba lavaparabrisas Berlingo, C2, C3, C3 Picasso, C4, C5, C8, DS3, Jumpy III, Saxo, Xsara II, Xsara Picasso, P-106 restyling, P-207, P-307, P-308, P-807, P-1007, Partner, Expert III (ver Renault)	190.361	6434.75
1	Bomba lavaparabrisas Berlingo, C2, C5, Saxo, Xsara II, Xsara Picasso, P-106, Partner (ver Renault)	190.376	6434.70
1	Bomba lavaparabrisas Citroën Jumper, Peugeot Boxer (ver Fiat)	190.383	6434.67
1	Bomba lavaparabrisas Citroën C-15 (ver Fiat)	190.385	6434.22
1	Bomba lavaparabrisas Berlingo, C1, C3 Pluriel, C4, C5, Jumpy, P-107, P-207, P-307, P-308, P-607, Expert (ver Dacia, Nissan, Renault)	190.388	6434.76



# P.S.A. (PEUGEOT / CITROEN)



163.032



182.308\*

\* (imagen NO a tamaño real)



163.200



162.879



163.880



163.495



163.913



164.385



164.381



164.387



164.388



164.389



164.390

U.E.	DESCRIPCION	Ref.	Adaptable
25	Fijac. insonorizantes AX, Berlingo, C8, Xantia, XM, Xsara, ZX, P-106, P-807, Partner	162.879	6992.V7
25	Fijac. tapa motor Berlingo, C4, C5, Xantia, Xsara, Xsara Picasso, P-206, P-306, P-307, P-406, P-607, Partner	163.032	0137.11
10	Soporte tapa motor Berlingo, C4, C5, Xantia, Xsara, Xsara Picasso, P-206, P-306, P-307, P-406, P-607, Partner	163.200	0137.23 0137.68
25	Fijac.insonorizantes capó Citroën Jumper III, Nemo, Peugeot Boxer III, Bipper (ver Fiat)	163.495	7979.H8
25	Fijac. tapa cubremotor Berlingo '09, C3 '09->, C4 '10->, C4 Picasso, C5 '08->, DS3, DS4, P-206, P-207, P-307, P-308, P-3008, P-5008, Expert III, Partner '09, Partner Tepee	163.880	6986.A8
25	Fijac. retrovisor Berlingo, Partner, fijac. cableria bajo capó y otros usos -varios modelos- (ver Renault)	163.913	6555.N7
10	Tope goma capó y portón AX, P-106, P-205, P-306 (ver Fiat, Renault)	164.381	
10	Tope goma capó Berlingo, C2, C5, Xsara Picasso, P-106, P-206, P-306, P-406, Partner	164.385	7908.67
10	Tope goma capó Berlingo '09->, C4 '04->'10, P-307, Partner '09->, Partner Tepee	164.387	8733.75
5	Tope goma capó (parte delantera del capó) C4 '10->, P-308, P-3008, P-5008, RCZ	164.388	8733.88
5	Tope goma capó (parte central del capó) C4 '10->, P-308, P-3008, P-5008, RCZ	164.389	8733.89
5	Tope goma capó DS3, C5 '04->, C6, P-206+, P-407	164.390	7908.F6
-	Tirante bandeja posterior P-106 (long.total 340 mm.)	182.308	

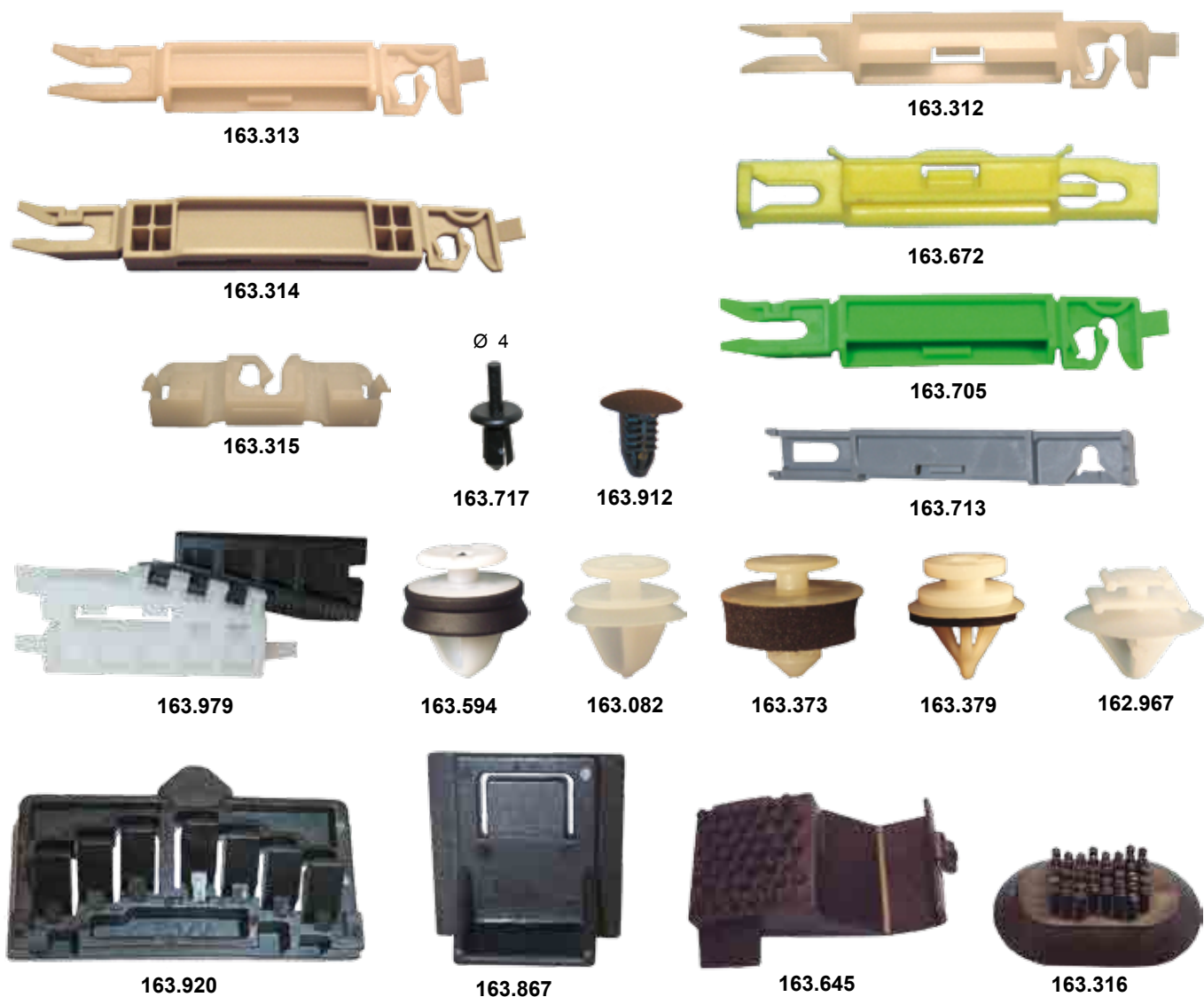

U.E.	DESCRIPCION	Ref. Adaptable
50	Fijac. rejilla parabrisas "torpedo" P-206 (Eurocode 6539ASCHB) (ver Renault)	<b>162.967</b> 8565.40 8565.63
50	Fijac. mold. lateral parabrisas C3 Pluriel (Euroc. 2730ASCTS1B) (ver Dacia, Renault, VAG, Volvo)	<b>163.082</b> 6991.S6
25	Fijac. moldura lateral parabrisas C2 (Eurocode 2731ASCSS)	<b>163.312</b> 8123.88
25	Fijac. moldura lateral parabrisas P-308, P-407 (Eurocode 6544ASCSS)	<b>163.313</b> 8123.89
25	Fijac. inferior moldura lateral parabrisas P-407 (Eurocode 6544ASCSS1B)	<b>163.314</b> 8123.90
25	Fijac. superior moldura lateral parabrisas P-407 (Eurocode 6544ASCSS2B)	<b>163.315</b> 8123.91
10	Base soporte parabrisas Berlingo, C4, Xantia, Xsara Picasso, ZX, Partner (Eurocode 2719ASCH)	<b>163.316</b> 8123.70 96 060 797
10	Fijac. moldura parabrisas P-1007 ('05->) (Eurocode 6547ASCSS)	<b>163.373</b> 8110.24
10	Fijac. moldura lateral parabrisas C4 Picasso (Eurocode 2735ASCMS) (ver Renault)	<b>163.379</b> 8123.96/7473FL
25	Fijac. rejilla parabrisas C4 Picasso (Eurocode 6558LSCVFD) (ver Ford)	<b>163.594</b> 9341.PF
10	Base soporte parabrisas Citroën Saxo, Peugeot 106 Restyling (Eurocode 6520ASMH)	<b>163.645</b> ● 8123.68
10	Fijac. moldura lateral parabrisas C5 '08->, P-508 (Eurocode 2740ASCSS)	<b>163.672</b> ● 8123.98
10	Fijac. moldura lateral parabrisas C6 (Eurocode 2733ASCSS)	<b>163.705</b> ● 8123.95
10	Fijac. moldura lateral parabrisas C4 '10->, DS4, P-3008, P-5008 (Eurocode 6560ASCMS1B)	<b>163.713</b> ● 8110.25
100	Remache fijac. moldura parabrisas P-206 y P-206+ (Eurocode 6539ASCSS)	<b>163.717</b> ● 6972.24
10	Base soporte parabrisas "torpedo" Jumper II, Boxer II '01->'06 (ver Fiat)	<b>163.867</b> ● 8120.S6
50	Fijac. rejilla parabrisas "torpedo" C-Crosser, P-4007	<b>163.912</b> ● 6823.54
10	Base soporte parabrisas "torpedo" Jumper III, Boxer III '06-> (ver Fiat)	<b>163.920</b> ● 8745.66
10	Fijac. moldura techo P-407 coupé	<b>163.979</b> ● 8321.31

# P.S.A. (PEUGEOT / CITROEN)



162.754

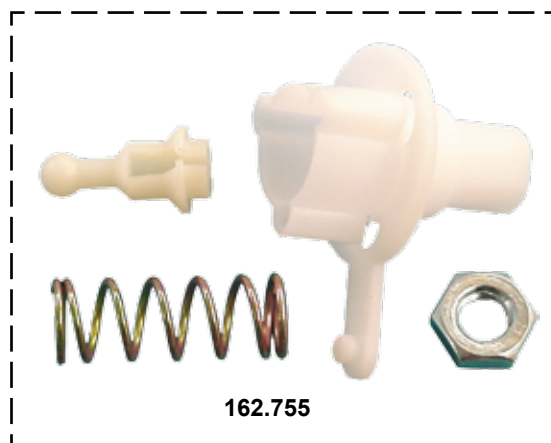

162.755



162.650



162.831



162.832



163.330 - Dcho.  
163.331 - Izdo.



163.631



163.633

U.E.	DESCRIPCION	Ref.	Adaptable
-	Regulador faro AX	162.650	95.634.217
10	Regulador faro C-15	162.754	75.5109.22
1	Kit regulador faro C-15 y AX	162.755	95.598.693
10	Casquillo regulador faro AX, BX, ZX, P-106	162.831	95583069
10	Aro regulador faro ZX, P-106	162.832	95564656 6225.66
5	Soporte faro Derecho. Xsara '00-'04	163.330	6212.58
5	Soporte faro Izquierdo. Xsara '00-'04	163.331	6212.57
25	Tuerca fijac. pilotos traseros C3 Pluriel, C4, C5 '01->'08, Jumpy III, P-207, P-307, P-407, Expert III	163.631	6545.86
25	Tuerca fijac. pilotos traseros P-407 (desde OPR 10101)	163.633	6347.47



171.434



171.433 \*

\* (imagen NO a tamaño real)



162.757



162.756



162.758



162.830

U.E.	DESCRIPCION		Ref. Adaptable
-	Regulador faro ZX, P-106, P-306	162.756	96.090.463
-	Regulador faro Jumpy I y II, ZX, P-106, P-306, Expert I y II	162.757	96.082.019 6224.79
-	Regulador altura faro Berlingo, Saxo, Evasion, P-106 restyling, P-306, P-405, P-406, P-806, Partner	162.758	6224.69
10	Casquillo sujeción faro ZX, P-106, P-306	162.830	6224.81
1	Regulador eléctrico faro Citroën C4 Picasso	171.433	6224.L1
1	Regulador eléctrico faro Berlingo, Evasion, Jumpy, Saxo, Xsara, Xsara Picasso, P-106, P-206, P-306 restyl., P-406, P-605, P-607, Expert, Partner (ver Fiat)	171.434	6224.C0

\* U.E.: Unidad de Envase

New 2009 ●

New 2010 ●

New 2011 ●

# P.S.A. (PEUGEOT / CITROEN)



162.547



162.813



162.858



162.859



163.084



163.318



162.983



162.485



163.322



163.176



162.936



161.470



161.471

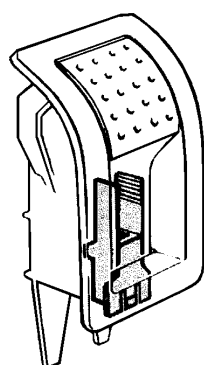

162.797



162.798



162.799



163.034

U.E.	DESCRIPCION	Ref.	Adaptable
25	Fijac. junta cristal Visa, C-15	161.470	6943.65
25	Fijac. junta cristal P-205, P-309	161.471	6996.28 6992.15
25	Fijac. varilla cerradura puerta Evasion, P-307, P-806 (ver Dacia, Renault)	162.485	
25	Fijac. varilla cerradura Peugeot	162.547	
10	Fijac. seguro puerta ZX, Xantia, XM	162.797	
10	Fijac. seguro puerta P-405, P-806 (ver Renault)	162.798	
10	Fijac. seguro puerta P-306	162.799	
25	Fijac. varilla cerradura Peugeot	162.813	
25	Fijac. varilla cerradura puerta Peugeot	162.858	
25	Fijac. varilla cerradura puerta AX, C5, C8, XM, ZX, P-106, P-205, P-206, P-306, P-309, P-405, P-406, P-605, P-607, P-807	162.859	9147.14 7903 079 144
25	Fijac. junta cristal Saxo, P-106	162.936	9313.09
25	Fijac. varilla cerradura Xsara I y II	162.983	6991.G0
1	Kit fijac. elevallunas Evasion, Jumpy I y II, P-806, Expert I y II (ver Fiat)	163.034	9227.31
25	Fijac. varilla apertura puerta Berlingo, C5 ->'08, C8, Jumpy I y II, Xantia, Xsara Picasso, P-206, P-306 restyling, P-807, Expert I y II, Partner	163.084	9147.32
25	Fijac. cristal lateral puerta trasera C5 '01->'08 (ver VAG)	163.176	9227.51
50	Fijac. varilla cerradura Berlingo, Xantia, P-306, Partner (ver Renault)	163.318	9147.04
25	Fijac. varilla cerradura C5 '01->'08, Xsara Picasso, P-206, P-306, P-406,	163.322	9147.21



162.856



162.857



162.901



163.582\* - Dcho.  
163.583\* - Izdo.



163.586\* - Dcho.  
163.587\* - Izdo.

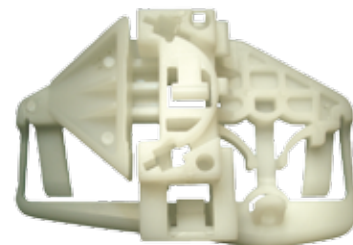

163.592\* - Dcho.  
163.593\* - Izdo.



163.596 - Dcho.  
163.597 - Izdo.



163.588\* - Dcho.  
163.589\* - Izdo.



163.590\* - Dcho.  
163.591\* - Izdo.



163.660\* - Dcho.  
163.661\* - Izdo.



163.662\* - Dcho.  
163.663\* - Izdo.



162.808



163.380

\* (imagen 1/2 tamaño real)

U.E.	DESCRIPCION	Ref. Adaptable	
10	Fijac. mecan. alzacrystales AX, Saxo, ZX, XM, P-106, P-306, P-406	162.808	
10	Sujec. cristal Saxo, P-106, P-306	162.856	9227.23
10	Sujec. cristal P-406	162.857	6999.93 6999.CW
10	Fijac. cristal Jumper, Boxer (ver Fiat)	162.901	9227.29
10	Fijac. mecanismo alzacrystales P-307 coupé y cabrio, P-308 berlina 3 puertas (ver Renault)	163.380	9159.A5
1	Soporte cristal elevalunas delantero derecho P-206 (ver Renault)	163.582	
1	Soporte cristal elevalunas delantero izquierdo P-206 (ver Renault)	163.583	
1	Soporte cristal elevalunas delantero derecho C3 (ver Renault)	163.586	
1	Soporte cristal elevalunas delantero izquierdo C3 (ver Renault)	163.587	
1	Soporte cristal elevalunas delantero derecho P-106, Saxo	163.588	
1	Soporte cristal elevalunas delantero izquierdo P-106, Saxo	163.589	
1	Soporte cristal elevalunas delantero derecho P-306	163.590	
1	Soporte cristal elevalunas delantero izquierdo P-306	163.591	
1	Soporte cristal elevalunas derecho Berlingo, Partner	163.592	
1	Soporte cristal elevalunas izquierdo Berlingo, Partner	163.593	
1	Soporte cristal elevalunas delantero derecho Xsara Picasso	163.596	
1	Soporte cristal elevalunas delantero izquierdo Xsara Picasso	163.597	
1	Soporte cristal elevalunas delantero derecho P-307 Coupé (ver Renault)	163.660	●
1	Soporte cristal elevalunas delantero izquierdo P-307 Coupé (ver Renault)	163.661	●
1	Soporte cristal elevalunas delantero derecho P-406	163.662	●
1	Soporte cristal elevalunas delantero izquierdo P-406	163.663	●

# P.S.A. (PEUGEOT / CITROEN)

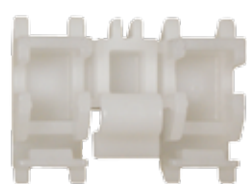

163.716



163.980



163.404



163.638



162.802



162.801



162.984



162.692



163.015



162.800



162.349



162.347



162.825



162.986



162.964



162.680



163.374

U.E.	DESCRIPCION	Ref. Adaptable
10	Fijac. moldura lateral Visa, C-15	162.347 6992.T0 95571660
10	Fijac. moldura lateral Visa	162.349 95556738
25	Fijac. moldura lateral Evassion, P-806 (ver Fiat)	162.680
10	Fijac. spoiler a parachoques C3, P-106, P-205, fijac. rejilla aire P-405	162.692 7420.47
50	Fijac. moldura lateral AX, C-15, ZX	162.800 9563 7051 6999.A2
10	Fijac. moldura pasoruada y bajopuerta AX	162.801 9563 7053
10	Fijac. moldura pasoruada y bajopuerta AX, Saxo, ZX	162.802 9563 7052
10	Fijac. moldura aleta delantera y capó C-15 moderna	162.825 9699 5446
10	Fijac. moldura puerta P-806, Citroen Evasión (ver Fiat)	162.964 96206697
50	Fijación rejilla de calandra Berlingo, C4, Evasion, Jumpy I y II, Xantia II, Partner, P-306, P-806, Expert I y II	162.984 6995.87
10	Fijac. moldura lateral puerta P-406 coupe	162.986 8565.41
10	Fijac. rejilla de calandra delantera (bajo faro) P-306 restyling	163.015 7813.26
10	Fijac. moldura lateral puerta P-407 coupe	163.374 8565.55
25	Fijac. aletas delanteras P-307 y fijac. aletas y capó P-3008	163.404 7840.L7
25	Fijac. aletas delanteras Citroën C4, Peugeot P-307, P-308	163.638 7840.L6
25	Fijac. moldura techo Peugeot P-307	163.716 8321.26
25	Fijac. moldura techo Peugeot P-308	163.980 8321.43



162.430



162.876



163.052



163.873



163.373



163.379



162.370



162.501



162.804



163.944



163.870



163.871



162.805

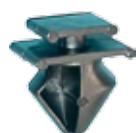

162.816



162.967



163.309



163.872



163.874

U.E.	DESCRIPCION	Ref. Adaptable
50	Fijac. (con boca premontada) molduras BX, ZX, Xantia, Berlingo	162.370 9566.7895
100	Fijac. moldura parachoques delantero y trasero BX, P-205	162.430 7437.07
50	Fijac. aletas, tapizados y panel puerta Berlingo, Partner, ZX, fijac. moldura portón trasero Berlingo, Partner, XM (ver VAG)	162.501 6991.N4 + 6979.C6
100	Fijac. (Ø 9,5) moldura puertas, aletas, talonera puerta y otros usos Berlingo, C2, C5, C6, Xantia, Xsara I y II, Xsara Picasso, Saxo, P-206, P-306 restyling, P-307, P-406, P-407, Partner	162.804 8565.35
50	Fijac. rejilla calandra Evasion, Jumpy I y II, P-206, P-806, Expert I y II, fijac. retrovisor P-206, fijac. moldura aletas, puerta y talonera P-106 Restyling, P-306	162.805 6995.X3
50	Fijac. moldura aletas y puerta P-106 restyling, P-406 (ver Renault)	162.816 8565.34
25	Fijac. moldura aletas y panel puerta Evasion, P-106, P-306, P-309 GTI	162.876 8565.20
50	Fij. aletas, molduras, panel puerta y parrilla lavaparabr. "torpedo" P-206 (Eurocode 6539ASCHB), fijac. aletas y moldura puerta Berlingo '09, C2, C3 Picasso y Pluriel, Evasion, Jumpy I y II, P-207, P-306, P-307, P-308, P-806, P-1007, Partner '09, Expert I y II, fijac. talonera puerta P-3008, fijac. parrilla radiador Saxo, fijac. tapizados maletero P-508 (ver Renault)	162.967 8565.40 8565.63
25	Fijac. moldura lateral Jumper II y III, Peugeot Boxer II y III (ver Fiat)	163.052 8565.43
50	Fijac. moldura lateral C4, Jumpy III, Expert III, fijac. panel puerta Expert III, Jumpy III, fij. deflector trasero (alerón) C4	163.309 8565.48 8565.60
10	Fijac. moldura parabrisas P-1007 ('05->) (Eurocode 6547ASCHS)	163.373 8110.24
10	Fijac. moldura lateral parabrisas C4 Picasso (Eurocode 2735ASCMS) y fijac panel puerta trasero C6, P-407 (ver Renault)	163.379 8123.96 7473.FL
50	Fijac. moldura lateral puerta P-308	163.870 8565.62
50	Fijac. moldura aleta delantera C3 Picasso	163.871 8123.A9
25	Fijac. moldura lateral puerta C4 Picasso, P-207 Coupé / Cabrio	163.872 8565.58
25	Fijac. moldura lateral puerta Berlingo '09, Partner '09, Partner Tepee	163.873 8565.68
10	Fijac. moldura lateral puerta Citroën C6	163.874 8565.51
25	Fijac. moldura portón trasero C4 '04->'10, C5 '04->'08	163.944 8742.Q6



# P.S.A. (PEUGEOT / CITROEN)



162.229



162.981



162.855



162.372



162.667



162.633



162.978



163.905



162.987



162.988



162.989



162.848



162.849



162.850

U.E.	DESCRIPCION	Ref. Adaptable
100	Fijac. panel puerta y revestimientos interiores P-405 (ver Fiat, Renault)	<b>162.229</b>
100	Fijac. panel puerta (con junta goma) AX, BX, C-15, Evasion, P-106, P-205, P-306, P-309, P-405, P-406, P-505, P-605, P-806 (ver Ford, Renault)	<b>162.372</b> 6992.51 6996.36 6995.A3 9615453880
100	Fijac. panel puerta y revestimientos interiores AX, Xantia, XM, Xsara I y II, ZX, P-306, P-309, Expert fijac. parrilla lavaparabrisas "torpedo" XM (Eurocode 2718ASCHB) (monta con 162.676)	<b>162.633</b> 6995.02 6999.CR
50	Fijac. panel puerta (con junta goma) Evasion, Jumpy I y II, P-205, P-806, Expert I y II	<b>162.667</b> 6992.82
25	Fijac. panel puerta Xantia I y II, ZX	<b>162.848</b> 96 126 454
25	Fijac. panel puerta Xantia, ZX	<b>162.849</b> 96 120 786
25	Fijac. panel puerta Xantia I y II	<b>162.850</b> 96 139 474
50	Fijac. panel puerta Evasion, P-405, P-605, P-806	<b>162.855</b> 6992.J4 96048533
50	Fijac. revestimientos interiores puerta AX, Evasion, Expert I y II, P-806 (monta con 162.446) fijac. parrilla lavaparabrisas "torpedo" Xsara I y II (Eurocode 2725ASCHB)	<b>162.978</b> 6995.S0
50	Fijac. panel puerta P-406	<b>162.981</b> 6995.Y5
50	Fijac. panel puerta Xsara I y II	<b>162.987</b> 6991.F4
50	Fijac. panel puerta Xsara I y II	<b>162.988</b> 6991.F5
50	Fijac. panel puerta Xsara I y II	<b>162.989</b> 6991.F6
10	Fijac. panel puerta Citroën Jumpy III, Peugeot 207, Expert III	<b>163.905</b> ● 9341.23



161.421



162.379



163.594



163.083



(pieza anterior  
sustituida)



163.669



163.234



163.082



163.453



163.727



163.708



163.161



163.501



162.980



162.803



163.378



163.876

U.E.	DESCRIPCION	Ref.	Adaptable
50	Fijac. panel puerta y revestimientos interiores P-205	161.421	6992.93
50	Fijac. panel puerta y revestimientos interiores C-25, J5 (ver Fiat)	162.379	8336.40
50	Fijac. revestimiento portón trasero y paneles laterales/puerta Berlingo, C3 Picasso y Pluriel, C5 '01->'04, Saxo, XM, Xsara I y II, Xsara Picasso, P-406, Partner	162.803	6990.50
50	Fijac. tapizados interiores P-106, P-206, P-307, fijac. tapizados portón trasero C4 Picasso, fijac. rejilla calandra C8	162.980	6991.E8 6966.39
50	Fijac. panel y revestimientos puerta Berlingo, C2, C3, C4, C4 Picasso, C5 '01->'08, C6, C8, Xsara Picasso, P-206, P-207, P-306, P-307, P-308, P-406, P-407, P-607, P-807, P-1007, Partner, fijac. aletas P-206, P-207 y fijac. moldura lateral parabrisas C3 Pluriel (Eurocode 2730ASCTS1B) (ver Dacia, Renault, VAG, Volvo)	163.082	6991.S6
25	Fijac. panel puerta y tapizados C2, C4 Picasso, C8, Jumpy III, P-207, P-407, P-807, Expert III, fij. aletas delanteras Berlingo '09, Jumpy III, Partner '09, Expert III, fij. parachoque trasero C3 Picasso (ver Fiat, Renault)	163.083	6991.Y8
25	Fijac. panel puerta C1, P-107 (ver Lexus, Suzuki, Toyota)	163.161	6822.LL
50	Fijac. tapizados portón P-307, fijac. tapizados interiores P-307, P-607, fijac. capó P-607, fijac. caja corrector faros C4, RCZ	163.234	6991.T3
10	Fijac. portón trasero P-407 SW, tapiz. interiores C6, moldura parabrisas C8, P-807 (ver Renault)	163.378	8742.G2
50	Fijac. panel puerta Expert III, Jumpy III, moldura lateral Expert (ver Fiat)	163.453	
50	Fijac. tapizado panel lateral Jumpy I y II, Expert I y II, fijac. tapizado techo C4 Picasso, Jumpy III, Expert III	163.501	8565.46
25	Fijac. panel puerta C3 '10->, C3 Picasso, C4, C4 Picasso, DS3, Jumpy 3, P-307, P-308, P-3008, P-5008, Expert 3, fijac. evacuador rejilla parabrisas C4 Picasso (Eurocode 6558LSCVFD), fijac. tapiz. interiores, portón trasero y retrovisores Berlingo '09, C5 '08->, P-508, Partner '09, fijac. tapiz. interiores P-407 (ver Ford)	163.594	9341.PF
25	Fijac. panel puerta Citroën C4 '10->, DS4, Peugeot P-508 (ver Renault)	163.669	9345.ZN
50	Fijac. panel puerta C3 '10->, C5 '08->, DS3, P-206 Coupé/Cabrio, P-207 Coupé/Cabrio, P-307 Coupé/Cabrio, P-308, P-607 restyling, P-1007, fijac. tapizados interiores C3 Pluriel, C4 Picasso, fijac. rejilla parabrisas C3 Pluriel	163.708	6991.S9
50	Fijac. tapizados techo y portón trasero C3 '09->, DS3, RCZ, tapizados interiores C4 '10->, P-5008 (ver Mini)	163.727	8337.FC
25	Fijac. tapizados portón trasero Citroën DS4 y Peugeot 308 break (ver Opel, Renault)	163.876	8748.QT

# P.S.A. (PEUGEOT / CITROEN)



U.E.	DESCRIPCION	Ref. Adaptable
100	Fijac. revestim. interiores AX, BX, ZX, XM, Xantia, P-106, P-205 (monta con 162.446)	<b>162.447</b> 7903 077 167
100	Fijac. aletas delanteras y traseras y tapizados interiores Berlingo, BX, C5, C8, Evasion, Saxo, Xantia, XM, Xsara II, Xsara Picasso, Jumpy I y II, P-106, P-306, P-405, P-406, P-806, P-807, Expert I y II, Partner, y fijac. rejilla lavaparabrisas Xantia I y II	<b>162.806</b> 6966.34 6992.95
100	Fijac. panel puerta Xantia	<b>162.883</b> 8326.N4
25	Fijac. tapizados interiores Xantia I y II, ZX, P-407	<b>162.941</b> 9699575280 7518.N8
25	Fijac. insonorizantes interiores Saxo, P-306	<b>162.942</b> 7903 077 172
50	Fijac. insonorizante capó Berlingo, C2, C3, C3 Picasso y Pluriel, C5 '01->'04, Saxo, Xantia, XM, Xsara I y II, Xsara Picasso, P-206, P-207, P-1007, Partner, Ranch	<b>163.017</b> 6995.V6
50	Fijac. revestimientos interiores y tapizados puerta Berlingo, Jumpy, Saxo, P-1007, P-106, P-205, P-306, P-806, Expert -todos-, Partner	<b>163.086</b> 6966.33
25	Fijac. tapizados portón trasero C5 '01->'04, Xsara Picasso	<b>163.136</b> 8748.Q5
10	Fijac. aislamiento capó Citroën C1, Peugeot 107 (ver Lexus, Toyota)	<b>163.258</b> 6822.N5
100	Fijac. aletas delanteras AX, BX, C-15, Saxo, Xantia, P-106, fij. aletas traseras P-106, P-206, P-406, fijac. revestimientos interiores AX, C-15, Berlingo, Xantia, XM, Xsara I y II, ZX, P-306, Partner, fijac. deflector P-306, y fijac. capó C4, C8, Jumpy III, ZX, P-106, P-306, P-307, P-807, Expert III	<b>163.308</b> 6992.C6
50	Fij. refuerzo parachoques delantero C5, C6, P-407, fijac. parachoques trasero P-407, fijac. revestim. interiores Jumpy III, Expert III	<b>163.317</b> 7437.10
25	Fijac. portón trasero y retrovisor C5 '01->'08, fijac. aletas delanteras ZX, fijac. otros usos Berlingo, C4 '11->, P-308	<b>163.326</b> 6547.20
100	Fijac. tapizados interiores Berlingo '09, C3, C3 Picasso y Pluriel, P-307, P-407, Expert III, P-1007, P-3008, Partner '09	<b>163.386</b> 7588.VX

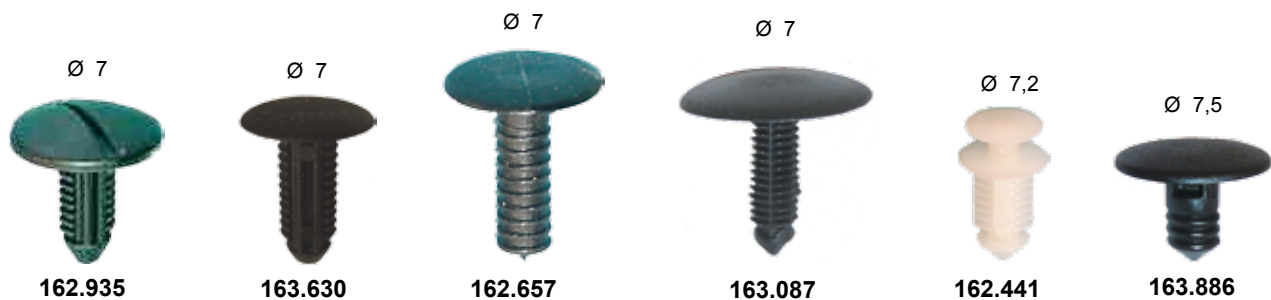

U.E.	DESCRIPCION	Ref. Adaptable
100	Fijac. tapicería Berlingo, P-106, P-206, P-307, P-405, P-605, Partner, fijac. capó P-206, P-307 (Negro) (ver Opel, Renault)	162.221 8964.57
100	Fijac. tapicería Berlingo, P-106, P-405, P-605, Partner (Gris) (ver Opel, Renault)	162.222
50	Fijac. tapicería Berlingo, P-106, P-405, P-605, Partner (Blanco) (ver Opel, Renault)	162.320
50	Fijac. revestimientos interiores P-205, P-309	162.440 6992.31
50	Fijac. revestimientos interiores Peugeot - varios -	162.441 6996.45
100	Fijac. revestimientos interiores Citroen/Peugeot (ver Mercedes, Renault)	162.453 6992.66
100	Fijac. tapizados AX, BX, C-15, ZX, parachoques trasero Xsara II, P-306, fijac. aletas delanteras ZX, fijac. cablería capó C4 Picasso (ver Renault)	162.454 6995.15
50	Fijac. aletas delanteras y tapizados interiores Boxer I, II y III, Jumper I, II y III (ver Fiat)	162.512 8331.38 8748.W4 8748.Y6
50	Fijac. tapizados piso Xantia I y II, ZX (ver Renault)	162.656 7518.N8
50	Fijac. revestimientos interiores AX, C-15, Saxo, P-106, P-205, P-206, P-306, P-309, P-405, P-406, P-605	162.657 6983.17
100	Fijac. revestimiento interior AX, BX, ZX (ver Fiat)	162.660
100	Fijac. tapizados interiores P-307 (ver Mercedes, Nissan, Renault)	162.934
100	Fijac. tapizados interiores AX, ZX, Saxo, Xantia, Berlingo, Evasion, P-106, Partner	162.935 6966.40
25	Fijac. tapizados interiores C8, Jumpy III, P-807, Expert III	163.087 7584.Z8
50	Fijac. pasoruera P-306, fijac. tapizados P-307, P-308, fij. insonorizante tablero C4, P-106, fijac. luna puerta C4 '11	163.201 8964.77
50	Fijac. revestimientos interiores traseros C4 '04->'10 y '11->, Evasion, P-206, P-308, P-405, P-806, P-1007, fij. rejilla parabrisas P-309, fij. tirante motor C4, C4 Picasso, P-307, P-308, P-3008, P-5008 fijac. cablería C4, Xsara Picasso, P-308, P-406, fijac. insonorizante capó Berlingo, Partner ->'03	163.630 6992.78
50	Fijac. pasoruera Berlingo, Xsara II, Partner, fij. parachoque trasero C3, fijac. aletas traseras Saxo, P-106, fijac. tapizados alfombra maletero C4, Saxo, P-106, P-206, P-207, P-307, P-406	163.886 7568.H0
25	Fijac. panel puertas traseras P-106 restyl., fijac. tapizados alfombra maletero P-406, fijac. parachoque trasero P-605	163.887 6995.40

# P.S.A. (PEUGEOT / CITROEN)



U.E.	DESCRIPCION	Ref. Adaptable
50	Boca fijac. revestimientos AX, Berlingo, C8, C6, Evasion, Jumpy I y II, XM, Xantia, Xsara, ZX, P-306, P-806, P-807, Expert I y II, Partner, fijac. aletas P-406 Coupé (monta con 162.447 y 162978)	162.446 6995.N7 9609212380
25	Fijac. tapizados interiores Peugeot/Talbot	162.549
25	Fijac. moldura techo P-207, P-307 (ver Ford)	162.618 8659.HQ
50	Boca (Ø 10) para revestimientos interiores ZX, Xantia, P-106, P-205, P-306, P-405, P-605 (ver Renault)	162.648
50	Boca (Ø 8) para panel puerta ZX (ver Renault)	162.675
50	Boca (Ø 8,2) para panel puerta Berlingo, Evasion, Jumpy I y II, Xsara Picasso, P-106, P-205, P-306, P-309, P-405, Expert I y II, Partner (monta con 162.633)	162.676 8565.17
50	Fijac. gomas puerta y capó Saxo, Xsara, Xantia, Berlingo, Evasión, Peugeot - varios modelos - (ver Fiat)	162.880 6992.K8 6999.A3
50	Fijac. gomas puerta y capó C8, Xsara I y II, Xsara Picasso, P-406, P-807 (ver Renault)	163.081 6997.86
50	Fijac. junta puerta P-307, P-607 (ver Ford, Renault)	163.135 6990.E0 9639570480
50	Fijac. junta portón trasero Jumper / Boxer I, II y III, fijac. moldura vierteaguas y fieltro capó P-307, P-406	163.179 8710.67 8710.84
50	Boca (Ø 8,2) fij. soporte para choques C3 Picasso, P-207, fijac. panel puerta Xsara II, P-106, P-406, fijac. panel portón trasero C3, P-3008, fijac. panel techo C8, Evasion, Jumpy, P-806, P-807, Expert, fij. pilotos traseros Saxo, Xantia, Xsara Picasso, P-206, fij. separador tabique Berlingo y Partner '09	163.376 6992.S2
25	Fijac. pasoruada Jumper, Boxer (ver Fiat)	163.493
25	Boca (Ø 9) fijac. panel puerta Jumpy I, II y III, Expert I, II y III, fij. detector presión ruedas C8, P-807	163.632 8565.47
10	Fijac. rejilla de calandra delantera Berlingo '02->'08, Partner '03->'08, fijac. deflector rejilla parabrisas P-306	163.634 6995.N3
50	Fijac. junta goma puerta delantera C5 '08->, delantera y trasera P-308, trasera P-3008, P-5008	163.715 9025.J8
10	Fijac. para choques delantero Berlingo, Partner '09->, fijac. protector bajos carrocería C3 '09->, C3 Picasso, DS3, C4 '10->, C4 Picasso, C8, Jumpy I, II y III, P-207, P-607, P-806, P-807, Expert I, II y III, RCZ	163.731 7481.GP



U.E.	DESCRIPCION	Ref. Adaptable
100	Fijac. tapizados traseros, portón trasero P-307, P-308, P-406, P-3008, P-5008, fijac. frontal ordenador C4 '11->	<b>162.237</b> 6987.A7
100	Fijac. revestimientos interiores, parachoques y aletas AX, Berlingo, BX, C3, C4, C4 Picasso, C5, C-15, Jumpy I, II y III, Saxo, Xantia, XM, Xsara, ZX, P-206, P-207, P-306, P-307, P-308, P-407, P-508, P-3008, P-5008, Expert I, II y III, Partner (ver Fiat, VAG)	<b>162.244</b> 6992.G2
25	Fijac. apoyabrazos AX, BX, XM, ZX, P-106, P-205, P-405	<b>162.371</b> 6992.87
25	Fijac. apoyabrazos AX, BX, ZX, Evasion, P-106, P-205/309, P-806	<b>162.518</b> 7903 081 055
50	Fijac. varios usos Berlingo, C4, C4 Picasso, C5, C6, C8, Evasion, Jumpy, Saxo, Xantia, XM, Xsara, Xsara Picasso, P-106, P-205, P-206, P-207, P-308, P-309, P-405, P-406, P-407, P-605, P-607, P-806, P-807, P-1007, Expert I, II y III, Partner (ver Fiat, Renault)	<b>162.523</b> 6992.80
10	Boca fijac. tapiz. interiores, alfombras piso Boxer / Jumper I y III Bipper / Nemo (ver Fiat)	<b>162.887</b> 6991.P2
50	Fijac. "torpedo" parabrisas y guarnecidos interiores Bipper, Nemo (ver Fiat)	<b>162.892</b> 8251.FC
50	Fijac. revestimientos interiores y varios usos Jumper, Boxer (ver Fiat)	<b>162.902</b>
25	Fijac. - varios usos - Berlingo, Jumpy I y II, Xantia, Xsara I y II, Xsara Picasso, P-306, P-406, P-607, P-806, Expert I y II, Partner	<b>162.982</b> 7410.E2
50	Fijac. panel puerta Jumpy III, Expert III, fijac. aletas P-206, P-406, fijac. parachoque trasero P-407	<b>162.985</b> 7136.A5
25	Fijac. revestim. interiores Berlingo '09, C3, C3 Picasso, C4, C4 Picasso, C5 '08->, DS3, Evasion, Jumpy I, II y III, Xantia, Xsara, Xsara Picasso, P-206, P-207, P-308, P-806, P-5008, Expert I, II y III, Partner '09, fijac. rejilla lavaparabrisas Berlingo, C5 '01->'08, Jumpy III, Expert III, Partner, fijac. parachoques Berlingo '09, C2, C3, DS3, Evasion, P-207, P-308, P-806, P-1007, Partner '09, (ver Dacia, Fiat, Opel, Renault)	<b>163.222</b> 6997.96
50	Fijac. - varios usos - Berlingo, C3, C3 Picasso y Pluriel, C4, C4 Picasso, C5, Xantia, P-205, P-207, P-309, P-607, P-1007, Partner	<b>163.377</b> 6991.39
50	Taco fijac. parachoques delantero C3, fijac. tapizados interiores Berlingo '09->, C4 '11->, C5 '08->, Partner Tepee '09->, P-207 coupé, P-308, P-508, P-3008, RCZ (ver Renault)	<b>163.502</b>
10	Fijac. parachoques Berlingo '02->'08, C3 ->'04, Xsara, Xsara Picasso, P-1007, Partner '02->'08, fijac. rejilla parabrisas («torpedo») P-306	<b>163.635</b> 6995.N4
25	Fijac. moldura vierteaguas trasero P-308	<b>163.730</b> 8525.NS
50	Fijac. parachoques delantero C3 '01->'05, fij. tapizados interiores Berlingo '09, C5 '08, DS4, P-207, P-308, P-407, P-508, P-3008, Partner Tepee, RCZ (ver Renault)	<b>163.881</b> 7568.NZ

# P.S.A. (PEUGEOT / CITROEN)

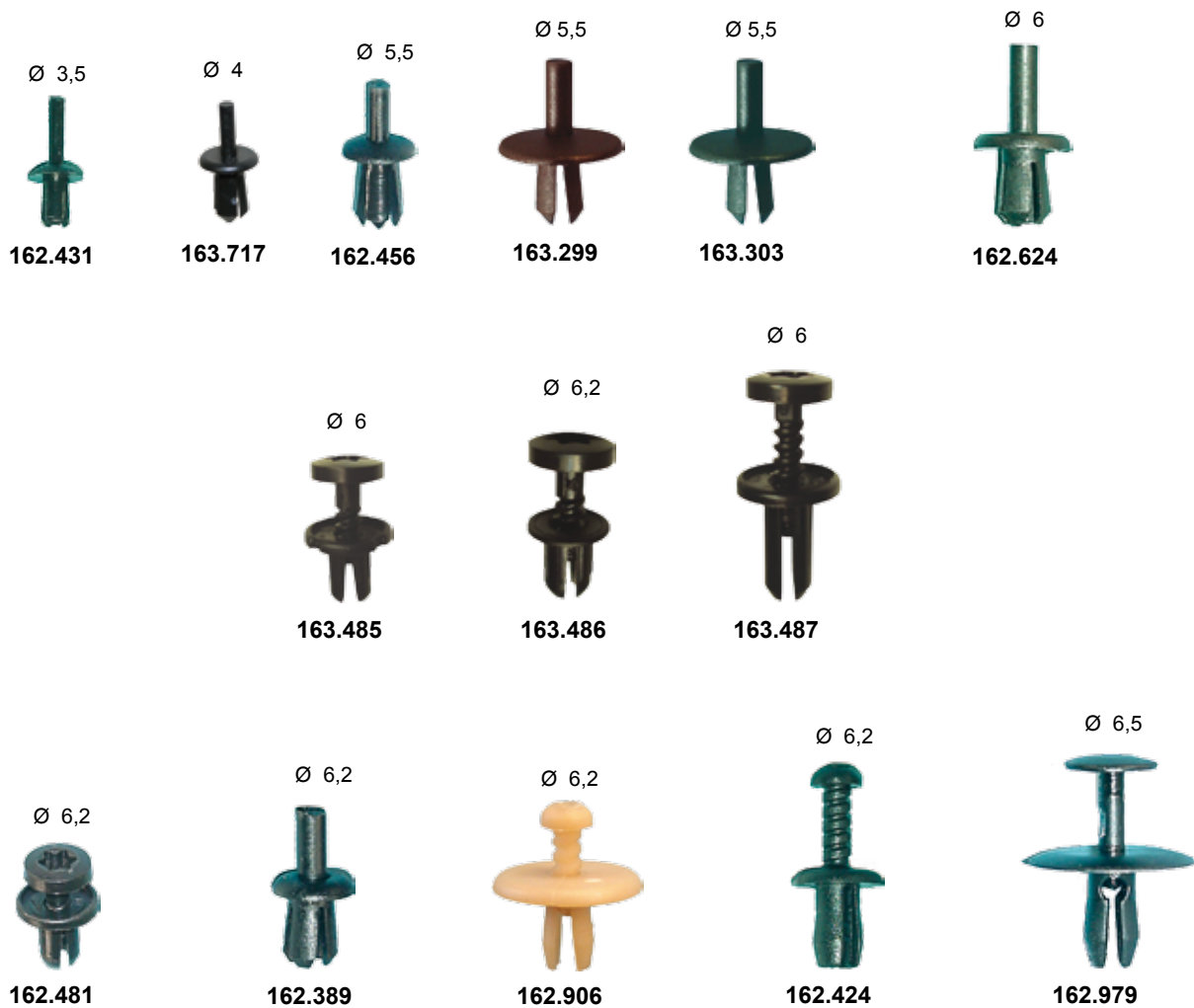

U.E.	DESCRIPCION	Ref. Adaptable
100	Remache fijac. varias aplicaciones Citroen (ver Fiat)	162.389 6972.02
50	Remache fijac. varias aplicaciones Citroen, P-309 (ver Fiat, Mercedes, Renault, VAG)	162.424
100	Remache fijac. varios usos XM, contorno puerta P-205, P-405, P-504 (ver BMW, Opel, VAG)	162.431 6972.07
50	Remache fijac. revestimiento interior Citroen, Peugeot (ver BMW, Mercedes, Renault)	162.456
50	Remache fijac. varios usos AX, XM, Xantia (ver Renault)	162.481
100	Remache fijac. para choques Citroen/Peugeot (ver Fiat)	162.624 6973.46
50	Remache fijac. varios usos AX, Berlingo, BX, C2, C3, C3 Picasso, C4, C4 Picasso, C5, C6, Jumpy I y II, Saxo, Xantia, XM, Xsara, P-106, P-206, P-306, P-307, P-308, P-405, P-406, P-407, P-508, P-607, P-806, P-1007, P-3008, P-5008, Expert I y II, Partner	162.906 1539.16
50	Remache fij. pasoruada, insonoriz. capó y rejilla calandra C8, Jumpy, P-206, P-307, P-807, Expert, fijac. panel puerta, tapizados, para choques, bajos carrocería C3 '10->, C3 Picasso y Pluriel, C4, C4 Picasso, C8, DS3, Jumpy III, Xsara, P-106, P-207, P-306, P-307, P-308, P-406, P-807, P-3008, P-5008, Expert III, fij. capó Berlingo '09, C5 '08, Evasion, P-407, P-806, Partner '09 (ver Fiat)	162.979 6997.T2 6997.83
50	Remache fijac. revestimientos interiores Jumpy (negra) (ver Fiat)	163.299
50	Remache fijac. para choques trasero P-307, tapiz. interiores puertas Jumpy I y II, Expert I y II (gris) (ver Fiat)	163.303 8748.C2
50	Remache fijac. para choques, tapizados interiores y otros usos Berlingo, C2, C3 '10->, C3 Picasso, C4, C4 Picasso, C5, C6, C8, DS3, Jumpy, Xantia, Xsara, Xsara Picasso, P-207, P-307, P-308, P-406, P-407, P-607, P-806, P-807, P-3008, P-5008, Expert I, II y III, Partner (ver VAG)	163.485 6555.LE
50	Remache fijac. varios usos C3, C4, C5, C8, P-307, P-607, P-807 (ver Renault)	163.486
50	Remache fijac. varios usos C3, C4, C5, C8, P-307, P-607, P-807 (ver Mercedes, Renault)	163.487
100	Remache fijac. moldura parabrisas P-206 y P-206+, fijac. junta puertas P-406, fijac. indicador estacionamiento C5	163.717 6972.24

Ø 7



163.529

Ø 7



163.167

Ø 8



162.373

Ø 8



163.085

Ø 8



163.014

Ø 8



163.166

Ø 8



163.344

Ø 8,5



162.341

Ø 8,5



163.127

Ø 8,5



163.963

Ø 8,5



163.981

Ø 9



163.358



162.708

U.E.	DESCRIPCION	Ref. Adaptable
100	Remache fijac. aletas delanteras Saxo, P-106, P-605, fijac. parachoques trasero Jumpy I y II, P-309, Expert I y II (ver VAG)	162.341 6973.34
100	Remache fijac. tapizados interiores y protecciones AX (ver Ford, Mercedes, Opel, VAG)	162.373
10	Remache fijac. tirante bandeja posterior C2, C3, DS3, Saxo, XM, Xsara Picasso, P-106, P-205, P-206, P-306, P-307, P-308	162.708 6992.18
50	Remache fijac. rejilla calandra P-306, P-406, fij. tapiz. maletero Jumpy I y II, Xsara II, P-307, P-308, Expert I y II, fijac. toma aire rejilla parabrisas P-206 (Eurocode 6539ASSHB) (ver Mercedes, VAG)	163.014 7813.24
25	Remache fijac. pasoruada, moldura inferior puerta y tapizados C2, C3 ('01->'10), C4 Picasso, C5 '01->'07, C6, P-1007, P-407, fijac. rejilla calandra y soporte parachoques Jumpy, Expert I, II y III (ver Opel)	163.085 6991.X7
50	Remache fijac. pasoruada trasero, bajos carroceria y tapa motor C4, C5 '01->'07, P-307, P-607, fijac. parachoques y tapizados interiores C4 Picasso, C6, C8, P-3008, P-807, fijac. pasoruada C3 ('01->'04), P-207, P-406 restyling,	163.127 7013.J0 8211.WV
10	Remache fijac. superior parachoques delantero C1, P-107 (ver Nissan, Toyota)	163.166 6822.N3
10	Remache fijac. spoiler trasero C1, P-107 (ver Lexus, Toyota)	163.167 6822.NK
50	Remache fijac. pasoruada, parachoques, tapa motor y bajos carroceria Berlingo '08->, C3 '10->, C3 Picasso, C4 '04->'10 y '11->, C5 '08->, C6, P-206, P-207, P-307, P-308, P-508, P-3008, P-5008, Partner '09->, RCZ, fij. tapiz. interiores, porton trasero y tapa motor C4 Picasso, Jumpy III, Expert III fijac. bajos carroceria C5 '05->'08, P-407,	163.344 8565.53
10	Remache fijac. parachoques trasero C1, P-107 (ver Lexus, Toyota)	163.358 7427.39
10	Remache fijac. pasoruada C1, P-107 (ver Lexus, Toyota)	163.529 6822.N2
25	Remache fijac. parrilla radiador Boxer III '06->, Jumper III '06-> (ver Fiat)	163.963 7813.29
10	Fijac. deflector aire delantero C1, P-107 (ver Lexus, Toyota)	163.981 6822.N7





U.E.	DESCRIPCION	Ref. Adaptable
50	Tornillo Ø 6 x 20, fijac. parachoques - varios modelos - (ver Fiat)	161.706 7703 001 123
25	Tornillo Ø 6 x 20, varios usos (ver Opel, PSA)	161.721
25	Tornillo Ø 6 x 20 (aro Ø 22), fijac. aletas y parachoques - varios - (ver Dacia)	161.724 7703 602 206
25	Tornillo Ø 6 x 20 (aro Ø 18), fijac. parachoques delantero Laguna III y varios usos (ver Dacia, Opel)	161.727 7703 602 282
25	Tornillo Ø 6 x 28 (aro Ø 24) fijac. parachoques trasero -varios modelos-, fijac. rejilla calandra Laguna III, Latitude	161.731 7703 602 059
10	Tornillo Ø 6 x 17,5, fijac. cerraduras Kangoo II, 4x4	161.732
10	Tornillo Ø 6 x 13, fijac. cerraduras Espace III, Express, Kangoo, Laguna, Master, Megane, Scenic	161.733
10	Tornillo Ø 6 x 18, fijac. cerraduras Clio III, Modus	161.734
25	Tornillo Ø 5 x 22 (aro Ø 16), fijac. pasoruada y parachoques Clio III, Kangoo II, Laguna III, Megane III, Twingo II, fijac. rejilla parabrisas Scenic III (ver Dacia, Opel)	161.750 7703 017 090
25	Tornillo Ø 5 x 17 (aro Ø 15), fijac. plásticas varias	161.762 7703 017 089
25	Tornillo Ø 6 x 26 (aro Ø 17), fijac. plásticas varias	161.763
25	Tornillo Ø 6 x 17, fijac. varios usos	161.769 7703 017 104 7703 017 087
50	Tornillo Ø 4,5 x 16, fijac. varios usos	161.777 7703 017 138 7703 017 097
50	Tornillo Ø 4,5 x 13, fijac. varios usos	161.778 7703 017 011 7703 017 108
25	Tornillo Ø 4,2 x 17 (aro Ø 14), fijac. pasoruada Laguna, Twingo (ver VAG)	162.702 7703 016 405



U.E.	DESCRIPCION		Ref. Adaptable
25	Tornillo fijac. guardabarros - modelos antiguos -	<b>161.432</b>	0607 273 300
10	Tornillo (en jaula móvil) fijac. parachoques Clio	<b>161.450</b>	
100	Remache 4 x 10, varios usos R-19, R-21, Espace, Traffic	<b>161.652</b>	
10	Tornillo fijac. parachoques Twingo (ver Fiat)	<b>161.705</b>	
10	Tornillo Ø 7 x 16 , fijac. cerraduras - varios modelos -	<b>161.728</b>	7703 005 065
10	Tornillo Ø 8 x 26,5 , fijac. cerraduras Espace III, Kangoo, Laguna, Master, Safrane	<b>161.729</b>	7703 026 053 7703 008 211
50	Remache Ø 2,4 x 5, varias aplicaciones (ver Fiat, Ford, Opel, PSA, V.A.G.)	<b>162.362</b>	7703 001 123
25	Tornillo Ø 6,3 x 16, fijac. guardabarros R-9/11, R-19, R-21, Clio, Super-5, Express, Megane, Laguna, Safrane, Twingo, Master, Traffic	<b>162.478</b>	7703 016 264
25	Tornillo fijac. guardabarros R-19, R-21, R-25, Clio, Super-5, Express, Safrane	<b>162.490</b>	7703 016 514
10	Tornillo fijac. parachoques R-5	<b>162.619</b>	7703 024 015
25	Remache fijac. (aro Ø 20) guardabarros Clio, Super-5, Express	<b>162.709</b>	7703 072 241
50	Remache 4,8 x 12 (cabeza de Ø 10) , varios usos R-21, R-25, Safrane	<b>162.939</b>	

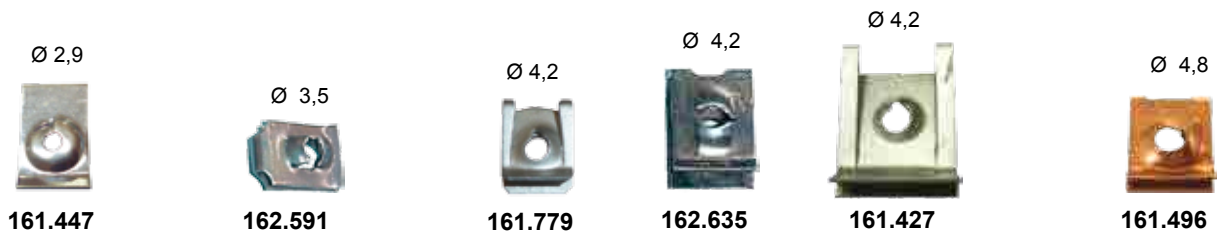

U.E.	DESCRIPCION	Ref. Adaptable
50	Clip fijac. protector guardabarros Clio I (ver BMW, Opel, VAG)	161.427
50	Clip fijac. guardabarros Twingo, Megane, Safrane	161.436
50	Clip fijac. varios usos R-9/11, Super-5, Express, Safrane, Master, Traffic	161.437 7703 046 012
50	Clip fijac. rejilla lateral R-5	161.447
50	Clip fijac. guardabarros Twingo, Megane, Safrane	161.449
50	Clip fijac. varios usos Renault (ver P.S.A.)	161.496 7703 046 032
10	Fijac. varios usos Clio III, Megane CC, Modus, Scenic II	161.725 7703 044 167
10	Fijac. aletas Scenic II	161.726
50	Fijac. varios usos R-19, R-21, R-25, Safrane (ver Dacia)	161.779 7703 046 143 7703 046 098
50	Clip (Ø 6,35) fijac. guardabarros R-9/11, R-19, R-21, R-25, Clio, Super-5, Express, Laguna, Twingo, Master, Traffic	162.479 7703 046 049
50	Clip (Ø 3,9) fijac. varios usos	162.591
50	Clip (Ø 6,3) fijac. varios usos	162.634
50	Clip fijac. piloto delantero R-5	162.635



161.703



162.444



161.438



162.442



161.499



162.465



162.466



162.328



162.711



162.712



162.375



161.467



161.478

U.E.	DESCRIPCION		Ref. Adaptable
50	Clip (Ø 6) fijac. pasoruedas R-9/11, Clio, Super 5, Express, Laguna, Safrane, Espace, Master, Trafic (ver Ford)	161.438	7703 046 034
10	Tuerca enjaulada especial Renault R-19 y otros modelos antiguos (Ø 6)	161.467	7703 044 037
50	Fijac. juntas estanqueidad puerta Megane, Scenic	161.478	
50	Clip fijac. talonera puerta Clio, Espace, Trafic (ver Ford, PSA)	161.499	7703 046 020
50	Clip fijac. varios usos Renault - varios modelos - (ver Ford, Mercedes)	161.703	7703 046 091
10	Tuerca bayoneta M-8 varios usos Renault	162.328	7703 044 121
25	Tuerca especial redonda varios usos (Ø 6) (ver Ford, PSA)	162.375	7703 044 058
50	Clip (Ø 6) fijac. pasoruedas R-9/11, Clio, Super-5, Express, Laguna, Safrane, Espace, Master, Trafic (ver Fiat, PSA, VAG)	162.442	7703 046 048
50	Clip fijac. protector - varios modelos -	162.444	
50	Fijac. varios usos R-9/11, R-19, R-21, Super-5, Express, Clio, Laguna, Safrane, Espace, Twingo, Master, Trafic (ver Fiat, Ford, PSA)	162.465	7703 044 087
25	Fijac. tirante bajopuerta R-19, R-21, Super-5, Express, Clio, Master, Trafic	162.466	7701 397 164 7703 044 013 7703 044 172
25	Tuerca con aro móvil (Ø 6), varios usos Megane, Laguna (ver Ford, Opel, PSA, VAG)	162.711	
25	Tuerca con aro móvil (Ø 8), varios usos Clio, Twingo (ver Ford, Opel, PSA, VAG)	162.712	7703 033 107



190.016



190.017



190.018



190.019



190.020



190.030



190.032



190.036



190.058



190.059



190.060



190.061



190.062



190.063



190.064

U.E.	DESCRIPCION	Ref. Adaptable
5	Surtidor lavaparabrisas Super-5, Express	190.016 7700 763 006
5	Surtidor lavaparabrisas Clio	190.017 7700 795 778
5	Surtidor lavaparabrisas R-19	190.018 7700 784 411
5	Surtidor lavaparabrisas R-21, Megane	190.019 7700 728 108
5	Surtidor lavaparabrisas Twingo	190.020 7700 821 295
5	Surtidor lavaparabrisas Laguna	190.030 7700 823 915
5	Surtidor lavaparabrisas Clio '98	190.032 7700 413 545
5	Surtidor lavaparabrisas Kangoo	190.036 7700 308 815
2	Surtidor luneta trasera Kangoo	190.058
2	Surtidor luneta trasera Laguna I, Megane I (14/10/98->)	190.059 7701 206 590
2	Surtidor luneta trasera Laguna I, Megane I (->13/10/98)	190.060 7700 838 380
2	Surtidor luneta trasera Laguna I, Megane Break	190.061 7701 206 591
5	Surtidor lavaparabrisas Megane II	190.062 8200 082 347
2	Surtidor luneta trasera Megane II	190.063 7700 846 208
2	Surtidor luneta trasera Scenic I	190.064 7700 846 317



190.361\*



190.374\*



190.375\*



190.376\*



190.377\*



190.362\*



190.388\*



190.387\*

\* (imagen 1/2 tamaño real)

U.E.	DESCRIPCION	Ref. Adaptable
1	Bomba lavaparabrisas Clio III, Espace IV, Laguna II, Megane II, Modus, Scenic II, Traffic II, Vel Satis (ver PSA)	190.361 7700 428 386
1	Bomba lavaparabrisas Clio II, Kangoo, Master, Megane I	190.362 7700 431 079
1	Bomba lavaparabrisas Clio II, Espace, Kangoo '97->'03, Laguna I, Megane I, Safrane, Scenic I, Twingo I	190.374 7700 430 702
1	Bomba lavaparabrisas Clio '96->'01, Espace, Kangoo '97->'03, Laguna I, Megane I, Scenic I, Twingo I	190.375 7701 048 307
1	Bomba lavaparabrisas Clio II, Kangoo, Master, Megane I, Safrane (ver PSA)	190.376 7700 431 079
1	Bomba lavaparabrisas R-19, R-21, Clio I '96->'98, Espace, Express, Kangoo, Master, Megane I, Safrane	190.377 7700 802 336
1	Bomba lavaparabrisas R-9, R-11, R-19, R-21, Super 5	190.387 7704 002 215
1	Bomba lavaparabrisas -varios modelos- (ver Dacia, Nissan, PSA)	190.388 7700 428 390

\* U.E.: Unidad de Envase

New 2009 ●

New 2010 ●

New 2011 ●



162.827



163.310



163.321



162.999



163.364



163.953



163.425

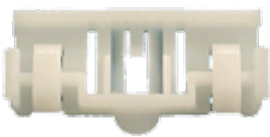

162.463



162.472



162.828



163.338

U.E.	DESCRIPCION	Ref.	Adaptable
10	Fijac. vierteaguas techo Clio	162.463	7703 077 300
25	Fijac. vierteaguas Twingo, Megane, Scenic, Master, Traffic	162.472	7703 077 341
10	Fijac. parabrisas R-21	162.827	7705 099 009
25	Fijac. moldura techo Clio '98	162.828	7703 077 438
10	Fijac. parabrisas Clio II ('98->), Clio III ('05->), Kangoo, Laguna II ('01->), Megane I, Megane II, Scenic II (Eurocode 7248ASCH)	162.999	7700 838 570
10	Base soporte parabrisas Clio I (incluye adhesivo) (Eurocode 7231ASFH/7232ASCH)	163.310	7700 789 274
10	Base soporte parabrisas R-19 (incluye adhesivo) (Eurocode 7236ASFH)	163.321	
10	Fijac. moldura techo Kangoo	163.338	7703 077 428 7700 351 266
10	Fijac. rejilla parabrisas Modus	163.364	8200 320 884
10	Base soporte parabrisas Master II (Eurocode 7247ASCV) (ver Fiat)	163.425	8200 333 033
10	Fijac. moldura techo Scenic II	163.953	7701 064 619



U.E.	DESCRIPCION	Ref. Adaptable
50	Fijac. rejilla parabrisas Vel Satis (ver PSA)	<b>162.816</b>
10	Fijac. moldura lateral parabrisas Scenic III '10-> (Eurocode 2735ASCMS) (ver PSA)	<b>163.379</b>
25	Fijac. moldura parabrisas Megane II Coupé / Cabrio (Eurocode 7261ASCC/AKCC1F) (componente del kit Renault 7701209200)	<b>163.595</b> 7701 057 073
10	Fijac. rejilla parabrisas "torpedo" Espace IV '02-> (Eurocode 7251ASCVB)	<b>163.670</b> ● 7701 056 146
25	Fijac. moldura techo-parabrisas Laguna III '07->	<b>163.671</b> ● 7701 053 507
10	Fijac. moldura lateral parabrisas Clio III, Symbol, Thalia (Eurocode 7262ASCHS)	<b>163.673</b> ● 7701 062 542 7701 070 377
10	Fijac. moldura lateral parabrisas (parte inferior) Clio III (Eurocode 7262ASCHS1B)	<b>163.674</b> ● 8200 335 703
10	Fijac. rejilla parabrisas "torpedo" Clio III	<b>163.720</b> ● 7701 070 605
10	Fijac. moldura parabrisas Megane II Coupé (Eurocode 7261ASCC6B) (componente del kit Renault 7701209200)	<b>163.737</b> ● 7701 061 133
25	Fijac. soporte rejilla calandra Megane III '09->, Fluence	<b>163.858</b> ● 7701 070 813
10	Fijac. moldura lateral parabrisas Vel Satis (Eurocode 7250ASCHS1B)	<b>163.868</b> ● 8200 294 204 8200 048 881
10	Fijac. moldura lateral parabrisas Megane III Coupé/Cabrio '10->	<b>163.948</b> ● 8201 111 623
1	Kit fijac. moldura parabrisas Laguna '94->'01 (contiene 11 piezas) (Eurocode 7237AKCH)	<b>163.959</b> ● 7701 367 683
1	Kit fijac. moldura parabrisas Scenic III '10-> (contiene 7 piezas) (Eurocode 7280AKCMS2F)	<b>163.978</b> ● 76 8E 608 98R

\* U.E.: Unidad de Envase

New 2009 ●

New 2010 ●

New 2011 ●





164.381



162.721



164.386



163.665



162.916



162.915



162.914

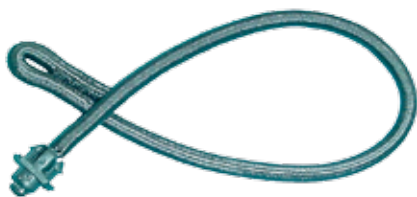

182.310\*



182.314\*

\* (imagenes NO a tamaño real)

U.E.	DESCRIPCION	Ref. Adaptable
-	Tope (goma) capó Clio	162.721 7700 818 973
10	Fijac. cableado (Ø 6-12) puerta Clio	162.914 7703 079562
10	Fijac. cableado (Ø 6-12) puerta Clio, Express, Megane	162.915 7703 079 351
10	Fijac. cableado (Ø 6-12) capó R-19, R-21, Twingo, Laguna, Traffic	162.916 7703 079 369
5	Soporte tapa superior motor Renault Kangoo	163.665 7701 056 972
10	Tope (goma) capó y portón Clio, Twingo, Master, Traffic (ver Fiat, PSA)	164.381
5	Tope (goma) capó Megane II	164.386 7700 843 546
-	Tirante bandeja posterior Clio (long.total 240 mm.)	182.310
-	Tirante bandeja posterior R-19, Megane (long.total 260 mm.)	182.314



163.224



163.885



163.366



163.138



162.722



162.723



162.724



163.223



163.471



163.913

U.E.	DESCRIPCION		Ref. Adaptable
10	Fijac. varilla capó Clio, Express	162.722	7703 077 199
10	Fijac. varilla capó Super-5, Express, Megane, Laguna, Master, Traffic	162.723	7703 079 328
10	Fijac. varilla capó Twingo	162.724	7703 079 714
10	Fijac. varilla capó Clio II	163.138	7703 077 439
10	Fijac. varilla capó Clio III, Laguna II, Megane II, Scenic II	163.223	7703 079 870
10	Fijac. varilla capó Clio III, Laguna II, Megane II, Modus, Scenic II	163.224	7703 179 010
10	Fijac. varilla capó Clio III	163.366	7705 002 130
10	Fijac. varilla capó Laguna III	163.471	7703 179 088
10	Fijac. varilla capó Laguna (ver PSA)	163.885	7703 079 812
25	Fijac. cableria -varos modelos- (ver PSA)	163.913	8200 222 830



162.694



163.202



163.203



163.668\*



163.383



163.214



163.215



162.829



163.137

\* (imagen 1/2 tamaño real)

U.E.	DESCRIPCION		Ref. Adaptable
10	Fijac. parachoques posterior Twingo	162.694	7700 817 502
10	Fijac. rejilla a parachoques Clio '98	162.829	7700 416 965
5	Fijac. aletas delanteras Clio II	163.137	7700 842 510
10	Soporte parachoques delantero Laguna II y III (lado derecho)	163.202	8200 138 448
10	Soporte parachoques delantero Laguna II y III (lado izquierdo)	163.203	8200 138 447
25	Fijac. (con inserto tornillo Ø6) rejilla radiador y otros usos R-21, R-25, Super-5, Express, Master, Trafic, Kangoo	163.214	7703 044 097
25	Fijac. (con inserto tornillo Ø6) rejilla radiador y otros usos R-21, R-25, Super-5, Express, Master, Megane, Laguna	163.215	7703 044 101
10	Fijac. aletas delanteras Clio II, Espace IV, Laguna II, Scenic	163.383	7700 412 158
1	Kit (2 piezas) soporte parachoques delantero Kangoo II '03->, Espace IV '02->, Laguna III '07->	163.668	8200 012 580



175.224 \*



175.225 \*



175.226 \*

\* (imagen 1/2 tamaño real)



163.340 - Dcho.

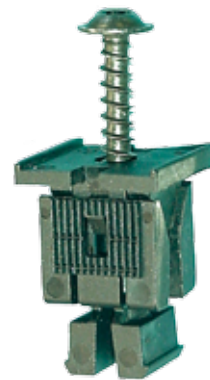

163.019



163.126



163.341 - Izdo.



163.342 - Dcho.



163.343 - Izdo.

U.E.	DESCRIPCION		Ref. Adaptable
10	Fijac. óptica Megane I (hasta ->9903)	163.019	7703 081 180
10	Fijac. soporte faro delantero Laguna II	163.126	7701 050 072
10	Fijac. derecha rejilla delantera a faro Megane I	163.340	7700 834 203
10	Fijac. izquierda rejilla delantera a faro Megane I	163.341	7700 834 202
10	Fijac. derecha rejilla delantera a faro Scenic I	163.342	7700 838 610
10	Fijac. izquierda rejilla delantera a faro Scenic I	163.343	7700 838 609
1	Regulador eléctrico faro Clio III, Espace IV, Kangoo '08, Laguna II y III '05->, Megane II '05->, Scenic III, Trafic II	175.224	8200 402 521
1	Regulador eléctrico faro Clio III, Espace IV, Laguna II '05->, Megane II '05->, Modus, Vel Satis (para faros Xenon)	175.225	8200 261 818
1	Regulador eléctrico faro Master '10->, Scenic II, Twingo '07->	175.226	8200 501 939



162.727



162.728



163.380



163.580\* - Dcho.  
163.581\* - Izdo.



163.574 - Dcho.  
163.575 - Izdo.



163.576\* - Dcho.  
163.577\* - Izdo.



163.578 - Dcho.  
163.579 - Izdo.



163.660 - Dcho.  
163.661 - Izdo.



162.306

\* (imagen 1/2 tamaño real)

U.E.	DESCRIPCION	Ref. Adaptable
10	Fijac. cristal lateral R-19, Clio, Megane (Eurocode 7231LSCHFDS)	162.306 7700 838 242
25	Fijac. mecanismo alzacristales R-19, Clio, Espace IV, Megane, Laguna II, Vel Satis (Eurocode 7239LSCHFD)	162.727 7700 784 690
25	Fijac. mecanismo alzacristales Clio, Laguna, Safrane, Espace	162.728 7700 757 267
10	Fijac. mecanismo alzacristales Clio III, Espace IV, Laguna II, Vel Satis (ver P.S.A.)	163.380
1	Soporte cristal elevallunas delantero derecho Megane I	163.574
1	Soporte cristal elevallunas delantero izquierdo Megane I	163.575
1	Soporte cristal elevallunas trasero derecho Megane I	163.576
1	Soporte cristal elevallunas trasero izquierdo Megane I	163.577
1	Soporte cristal elevallunas delantero derecho Scenic I	163.578
1	Soporte cristal elevallunas delantero izquierdo Scenic I	163.579
1	Soporte cristal elevallunas trasero derecho Scenic I	163.580
1	Soporte cristal elevallunas trasero izquierdo Scenic I	163.581
1	Soporte cristal elevallunas delantero derecho Laguna II (ver PSA)	163.660
1	Soporte cristal elevallunas delantero izquierdo Laguna II (ver PSA)	163.661



**163.582\*** - Dcho.  
**163.583\*** - Izdo.



**163.584\*** - Dcho.  
**163.585\*** - Izdo.



**163.586\*** - Dcho.  
**163.587\*** - Izdo.

\* (imagen 1/2 tamaño real)



U.E.	DESCRIPCION		Ref. Adaptable
25	Fijac. anagrama capó Clio, Espace, Express, Master, Safrane, Super-5, Traffic, Twingo	<b>162.471</b>	7703 081 161
25	Fijac. letreros R-5	<b>162.595</b>	7703 081 003
25	Fijac. anagrama capó Clio, Espace, Laguna, Master, Megane, Safrane, Traffic, Twingo	<b>162.700</b>	7703 081 170 7703 081 190
25	Fijac. anagrama portón y siglas modelo Clio, Express, Laguna, Master, Megane, Safrane, Super-5, Traffic, Twingo	<b>162.701</b>	7703 081 151
25	Fijac. monograma Clio II, Scenic II	<b>163.042</b>	
10	Fijac. anagramas Espace IV, Laguna II, Megane II	<b>163.146</b>	8200 305 109
50	Fijac. anagramas Clio III, Espace IV, Kangoo II, Laguna I / II y III, Megane II, Megane III, Modus, Scenic II, Twingo II	<b>163.362</b>	7703 081 224
10	Fijac. anagramas Clio III, Espace IV, Megane II, Twingo II, fijac. embellecedor superior aleta Megane III, Clio III	<b>163.452</b>	7703 081 212
1	Soporte cristal elevalunas delantero derecho Megane II (ver PSA)	<b>163.582</b>	
1	Soporte cristal elevalunas delantero izquierdo Megane II (ver PSA)	<b>163.583</b>	
1	Soporte cristal elevalunas trasero derecho Megane II	<b>163.584</b>	
1	Soporte cristal elevalunas trasero izquierdo Megane II	<b>163.585</b>	
1	Soporte cristal elevalunas delantero derecho Clio II, Scenic II (ver PSA)	<b>163.586</b>	
1	Soporte cristal elevalunas delantero izquierdo Clio II, Scenic II (ver PSA)	<b>163.587</b>	



162.426



162.860



162.861



162.862



162.863



162.864



162.865



162.866



162.485



162.867



162.868



163.318

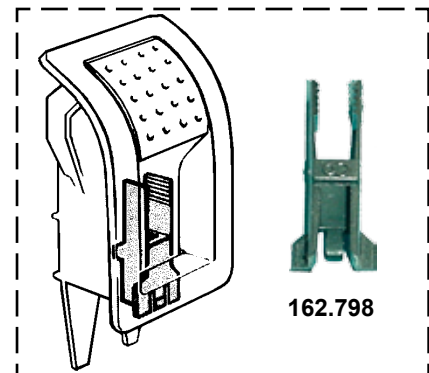

162.798

U.E.	DESCRIPCION		Ref. Adaptable
25	Fijac. varilla cerradura puerta R-11, R-19, Clio, Super-5, Express, Megane, Laguna, Safrane, Espace	162.426	7701 030 059
25	Fijac. varilla cerradura puerta Clio, Espace, Super-5, Express, Safrane, Twingo, Master, Traffic (ver Dacia, PSA)	162.485	7703 079 027 7703 079 290
10	Fijac. seguro puerta Laguna, Safrane (ver P.S.A.)	162.798	- sin despiece -
25	Fijac. varilla cerradura puerta Twingo	162.860	7701 408 876
25	Fijac. varilla cerradura puerta R-19, Clio, Super-5, Express, Laguna, Safrane, Twingo, Espace, Master, Traffic	162.861	7701 030 058
25	Fijac. varilla cerradura puerta R-19, Clio, Super-5, Express, Megane, Laguna, Safrane, Twingo, Espace	162.862	7701 030 060
25	Fijac. varilla cerradura puerta Clio, Megane, Laguna, Safrane	162.863	7701 035 664
25	Fijac. varilla cerradura puerta Clio	162.864	7701 408 875
25	Fijac. varilla cerradura puerta Clio	162.865	7701 408 877 7703 079 714
25	Fijac. varilla cerradura puerta Megane	162.866	
10	Fijac. varilla cerradura puerta Clio, Safrane	162.867	7700 801 556
10	Fijac. varilla cerradura puerta Clio, Safrane	162.868	7700 801 557
50	Fijac. varilla cerradura puerta Kangoo (ver PSA)	163.318	



162.475



162.477



163.081



163.135



163.143



163.182



163.225



163.325



162.881



163.450



163.451



162.912

U.E.	DESCRIPCION		Ref. Adaptable
25	Fijac. junta estanqueidad puerta Clio I (ver Fiat)	162.475	7701 408 860
10	Fijac. junta estanqueidad puerta Clio I	162.477	
50	Fijac. goma capó Laguna, Safrane, y junta puerta delantera Safrane	162.881	
10	Tapón agujeros puerta Clio, Megane, Laguna, Master II, Traffic	162.912	7703 074 112
50	Fijac. gomas puerta y capó Kangoo, Laguna, Master (ver P.S.A.)	163.081	
50	Fijac. juntas estanqueidad Laguna, Kangoo, Master (ver Ford, PSA)	163.135	7701 044 547
25	Fijac. junta capó Espace IV, Vel Satis	163.143	
50	Fijac. junta goma puerta Megane II	163.182	- sin despiece -
50	Fijac. junta goma puerta Megane II (ver Volvo)	163.225	8201 033 717
50	Fijac. gomas puerta y capó Clio III, Traffic II	163.325	
50	Fijac. (Ø 5,2) gomas puerta Clio III	163.450	
50	Fijac. (Ø 6,2) gomas puerta Clio III	163.451	





162.462



162.327



162.681



162.682



162.996



162.473



162.474



162.488



162.489



162.687



162.683



162.684



162.685



162.686

U.E.	DESCRIPCION	Ref. Adaptable
10	Fijac. molduras Express (metálica)	162.327 7703 080 048
5	Fijac. molduras laterales R-21	162.462
25	Fijac. molduras laterales Clio (1ª serie) (color blanco)	162.473 7701 408 846
25	Fijac. molduras laterales Clio (1ª serie) (color rojo)	162.474 7701 408 847
25	Fijac. molduras laterales Clio (2ª serie) (color blanco)	162.488 7703 077 362
25	Fijac. molduras laterales Clio (2ª serie) (color rojo)	162.489 7703 077 363
10	Fijac. molduras laterales Megane, Scénic (color blanco/rojo)	162.681 7701 043 799
10	Fijac. molduras laterales Megane, Scénic (color blanco/azul)	162.682 7701 040 837
10	Fijac. molduras laterales Laguna (color verde)	162.683
10	Fijac. molduras laterales Laguna (color blanco)	162.684
10	Fijac. molduras laterales Laguna (color rojo)	162.685
10	Fijac. molduras laterales Laguna (color gris)	162.686
10	Fijac. molduras laterales Laguna (color blanco)	162.687
25	Fijac. molduras Clio II, Kangoo II, Laguna II, Megane, Scénic RX4	162.996



161.423



163.144



163.504



163.446



162.967



163.714



163.718



163.719



162.997



162.995



163.444



163.445



162.962



162.992



162.993



162.994



162.824

U.E.	DESCRIPCION	Ref. Adaptable
100	Fijac. molduras R-19, Clio I, Laguna, Safrane	161.423 7703 077 256
50	Fijac. molduras R-19, Clio II, Kangoo, Laguna, Megane, Scénic, Trafic II (ver Opel) (componente del kit Renault Trafic II OEM: 7701 470 769)	162.824 7703 077 309
50	Fijac. molduras puertas Clio II, Kangoo, Megane, Megane II Coupé, Scenic III, Vel Satis	162.962 7701 047 661
50	Fijac. molduras laterales Fluence, Megane III, Twingo II (ver PSA)	162.967 7701 049 270
50	Fijac. molduras Kangoo, Master (ver Fiat, Opel)	162.992 7703 077 420
50	Fijac. molduras Kangoo, Master, Trafic II, fijac. panel portón trasero Kangoo (ver Fiat, Opel) (componente del kit Renault Trafic II OEM: 7701 470 769)	162.993 7703 077 422
25	Fijac. molduras Kangoo, Master, Trafic II (componente del kit Renault Trafic II OEM: 7701 470 769) (ver Opel)	162.994 7703 077 421
25	Fijac. molduras laterales Kangoo	162.995 7703 077 448
10	Fijac. molduras Espace IV	162.997
25	Fijac. bandas laterales Scenic RX4	163.144 7701 050 730 7701 048 296
25	Fijac.(Ø 8,2) bandas portón y maletero Clio II	163.444
25	Fijac.(Ø 12,2) bandas portón y maletero Clio II, Megane Break	163.445
25	Fijac. molduras laterales Clio III, Megane III Coupé, Twingo II	163.446 7701 061 797
10	Fijac. aleta delantera Clio III, Twingo II	163.504 8200 389 607
25	Fijac. molduras puertas y techo Espace IV	163.714 7701 056 059
10	Fijac. molduras laterales puerta Megane II	163.718 8200 666 724 8200 369 224
10	Fijac. molduras laterales puerta Scenic II	163.719 8200 699 857 8200 369 854



162.672



163.043



163.092



162.998



163.876



163.382



163.115



163.381



6 x 7

162.673



6 x 7

162.451



7,5 x 8

162.452



162.229



162.372



162.668



162.669



162.234



163.737

U.E.	DESCRIPCION	Ref.	Adaptable
100	Fijac. panel puerta y revestimientos interiores R-5, R-12, R-18 (ver Fiat, PSA)	162.229	7703 077 059
50	Fijac. panel puerta y vano rueda Super-5, Express	162.234	7703 077 193
100	Fijac. panel puerta y revestimientos interiores R-5, R-9/11, Super-5, Express, Master, Traffic (ver Ford, PSA)	162.372	7703 077 111
25	Fijac. revestimientos interiores R-9/11, R-5, Super-5, Express	162.451	7703 077 109
25	Fijac. revestimientos interiores R-9/11, R-21, Super-5, Express	162.452	7703 077 108
25	Fijac. panel puerta R-21, R.25, fijac. embellecedor exterior techo Megane II, Trafic II	162.668	7703 077 183
25	Fijac. panel puerta y revestimientos interiores Kangoo, Laguna, Safrane	162.669	7703 077 345
10	Fijac. (con boca premontada) revestimientos interiores Super-5	162.672	7703 077 243
25	Fijac. revestimientos interiores Super-5, Express	162.673	7703 077 192
25	Fijac. guarnecidos interiores Clio II, Megane I	162.998	
25	Fijac. paneles portón posterior y montantes cinturón seguridad Kangoo, fijac. tapizados interiores Clio II, Trafic II	163.043	7703 077 434
50	Fijac. tapizados portón trasero Espace III	163.092	
25	Fijac. tapizados interiores Master II (ver VAG)	163.115	251 867 299
10	Fijac. tapizados interiores Modus	163.381	8200 302 291
25	Fijac. tapizados interiores Master	163.382	7703 077 457
10	Fijac. moldura parabrisas Megane II Coupé, Scenic III (Eurocode 7261ASCC6B)	163.737	7701 061 133
25	Fijac. tapizados interiores -varios modelos- (ver Opel, PSA)	163.876	7703 077 477



163.139



163.142



163.145



163.378



163.379



161.422



162.961



162.826



163.141



162.816



163.858



163.891



163.595



163.082



163.083



163.669

U.E.	DESCRIPCION	Ref. Adaptable
50	Fijac. panel puerta y revestimientos interiores R-19, Clio I y II, Megane I y II, Kangoo, Laguna I y II, Modus, Safrane, Twingo, Master, Trafic	161.422 7703 077 250
50	Fijac. rejilla parabrisas Vel Satis (ver PSA)	162.816
25	Fijac. panel puerta Clio II, Kangoo, Megane, Scénic, fijac. rejilla parabrisas Master '10->, Trafic II (ver Opel)	162.826 7703 077 430
50	Fijac. panel puerta Megane, Clio'98, Kangoo, fijac. otros usos Laguna I, Megane II, Trafic I	162.961 7703 077 354
50	Fijac. panel puerta Clio III, Kangoo, Scenic II y RX4, Vel Satis, fijac. parachoques trasero Megane II, fijac. panel puerta y embellecedor exterior Espace IV (ver Dacia, PSA, VAG, Volvo)	163.082 7701 056 846
25	Fij. panel puerta y rejilla delantera Megane II, Scenic II, Twingo II, fijac. tapiz. interiores Clio II, Scenic II, Megane III, fijac. moldura lateral Espace IV, Kangoo II, Megane III, Master '10->, fijac panel puerta, tapizados y alerón Clio III, fijac. rejilla delantera a faro Kangoo, fijac. moldura superior parabrisas y luneta trasera Megane III Coupé, fijac. moldura portón trasero Symbol / Thalia, fijac. otros usos Modus, Vel Satis (ver Fiat, PSA)	163.083 7703 077 469 7703 077 468 8201 112 162
10	Fijac. tapizados portón trasero Scenic I	163.139 7703 077 441
25	Fijac. panel puerta y tapizados interiores Espace IV, Laguna II, Trafic II (ver Opel)	163.141 7701 050 734 5001 855 049 7703 077 368
25	Fijac. moldura rejilla parabrisas Twingo II '07->, fijac. molduras laterales Scenic RX4, fijac. tapizados interiores Laguna II, Megane CC, Modus, Scenic RX4, Vel Satis,	163.142 7701 049 008 7701 057 132
10	Fijac. tapizados portón trasero Laguna II, Espace IV	163.145 7701 058 820
10	Fijac. panel puerta Laguna II (ver PSA)	163.378
10	Fijac. moldura lateral parabrisas Scenic III (Eurocode 2735ASCMS) (componente del kit OEM: 768E60898R) (ver PSA)	163.379
25	Fijac. tapizados interiores Megane II 2 puertas y Megane CC, fij. moldura parabrisas Megane II CC (Eurocode 7261ASCC/AKCC1F)	163.595 7701 057 073
25	Fijac. panel puerta Laguna III, Latitude, Megane III, Fluence, Scenic III, Master III '10-> (ver PSA)	163.669 7703 077 476
25	Fijac. soporte rejilla calandra Megane III, Fluence	163.858 7701 070 813
25	Fijac. tapizados puerta Trafic II	163.891 8200 186 255



162.705



162.450



163.447

Ø 6,2



163.385

6,2 x 12,2



162.875

Ø 6,5



163.327

Ø 6,5



162.975

Ø 6,5



162.823

Ø 6,5



162.643

Ø 6,5



163.879

Ø 6,7



163.006

Ø 6,7



163.007

U.E.	DESCRIPCION	Ref. Adaptable	
50	Fijac. aislante vano motor R-19, R-21, R-25, Clio, Super-5, Kangoo, Express, Megane, Modus, Laguna, Safrane, Master, Traffic	162.450	
100	Fijac. tapizados interiores - varios modelos -	162.643	7703 077 079
25	Fijac. spoiler a parachoques delantero Clio	162.705	7703 077 080
100	Fijac. tapizados interiores - varios modelos - (ver Seat)	162.823	7703 077 223
25	Fijac. protector pasorueda Megane, Scénic, Laguna	162.875	7703 081 188
25	Fijac. aislante capó Renault - varios -, fij. alfombra Clio II y III	162.975	7703 077 444
50	Fijac. pasorueda Laguna II y III, Latitude, fijac. tapiz. alfombras piso Latitude, Megane III, Scenic III, fijac. insonoriz. capó Clio III, Megane II y III, Scenic II y III, Master III (ver Dacia)	163.006	7703 077 117
50	Fijac. insonorizante capó Laguna II (negra)	163.007	6001 546 909
25	Fijac. insonorizante capó Laguna II y III, Master, Vel Satis	163.327	7703 077 453
25	Fijac. tapizados interiores Traffic (ver Nissan, Opel)	163.385	7703 077 471
50	Fijac. tapizados interiores Kangoo	163.447	
50	Fijac. tapizados interiores Master III '10->	163.879	8200 939 873



U.E.	DESCRIPCION	Ref. Adaptable
100	Fijac. panel y tapicería todos los modelos (Negro) (ver Opel, PSA)	<b>162.221</b>
100	Fijac. panel y tapicería todos los modelos (Gris) (ver Opel, PSA)	<b>162.222</b> 7703 081 185
50	Fijac. panel y tapicería todos los modelos (Blanco) (ver Opel, PSA)	<b>162.320</b>
100	Fijac. revestimientos interiores R-9, R-11, R-19, R-21, R-25, Super-5, Express, Clio, Megane, Twingo, Laguna, Safrane, Espace (ver Mercedes, PSA)	<b>162.453</b> 7703 077 068
100	Fijac. revestimientos interiores R-9/11, R-5, R-18, R-19, Super-5, Express, Espace, Safrane (ver PSA)	<b>162.454</b> 7703 077 066 7703 077 148
100	Fijac. tapizados interiores - varios modelos -	<b>162.646</b>
50	Fijac. pasorueda R-19, R-25, Clio, Super-5, Express, Kangoo, Megane, Twingo, Laguna, Safrane, Master, Traffic (ver PSA)	<b>162.656</b> 7703 077 225
100	Fijac. tapizados interiores - varios modelos - (ver Mercedes, Nissan, PSA)	<b>162.934</b> 7703 077 153 7703 077 356
25	Fijac. revestimientos interiores R-19, R-21, R-25, Super-5, Express, Twingo, Clio I y III, Laguna I y II, Safrane, Master, Traffic (ver Dacia, PSA)	<b>162.941</b> 7703 081 054
50	Fijac. pasorueda Clio II y III, Espace IV, Kangoo I y II, Laguna I, II y III, Latitude, Megane I, II y III, Master II y III, Modus, Scenic I, II y III, Twingo I y II, fijac. alfombras Laguna II y III, Megane II y III, Scenic II y III (ver Dacia)	<b>163.008</b> 7703 077 435
25	Fijac. insonorizante y tapizados interiores Clio III, Fluence, Latitude, Master III, Megane II y III, Scenic II y III, Twingo II, fijac. vierteaguas lateral Fluence, Megane III, fijac. rejilla calandra Twingo II '07-> (ver Dacia)	<b>163.906</b> 7703 081 227



163.428



163.429



163.324



163.363



163.320



161.424



162.932



162.675



162.648

U.E.	DESCRIPCION		Ref. Adaptable
25	Fijac. apoyabrazos y manecilla puerta R-5, R-9/11, R-18, R-19, Super-5, Express	161.424	7703 081 013
50	Boca (Ø 10) para revestimientos montante Megane (ver PSA)	162.648	7700 836 190
50	Boca fijac. panel puerta y tapizados R-21, Super-5, Express, Laguna (ver PSA)	162.675	7701 397 195
25	Fijac. rejilla delantera R-19, R-21	162.932	7703 081 103
50	Fijac. insonorizantes y pasoruada Clio III, Laguna II y III, Latitude, Megane III, Modus, Scenic II y III, Twingo II, Vel Satis (ver Dacia)	163.320	7703 081 056
25	Fijac. frontales y pasoruada Megane II	163.324	- sin despiece -
25	Fijac. rejilla a calandra Kangoo II, fijac. pasoruada Espace IV, Master III '10->	163.363	7703 081 155
25	Fijac.varios usos Scenic II, Twingo II (ver V.A.G.)	163.428	
25	Fijac.varios usos Clio III	163.429	7703 081 222



U.E.	DESCRIPCION		Ref. Adaptable
100	Taco fijac. revestimientos interiores R-9/11, R-19, R-21, R-25, Clio, Safrane, Espace, Master, Trafic, fijac. vano rueda Twingo, fijac. molduras Express (ver Fiat, Ford, Mercedes, Seat)	<b>162.238</b>	7703 081 086
25	Taco fijac. revestimiento puerta Megane, fijac. apoyabrazos Clio	<b>162.468</b>	7703 081 147
25	Taco fijac. guía puerta y tapicería Twingo, Master, Traffic	<b>162.483</b>	7703 081 134
50	Taco fijac. varios usos R-9/11, Clio, Super-5, Express, Megane, Laguna, Safrane, Twingo, Espace, Master, Traffic (ver Fiat, PSA)	<b>162.523</b>	7703 081 019
100	Taco fijac. varios usos Renault	<b>162.649</b>	
25	Taco fijac. revestimiento portón Laguna	<b>162.717</b>	
25	Taco fijación parachoques Kangoo II, Megane, Scénic, Twingo II, fijac. panel puerta Megane III y otros usos varios modelos (ver Opel)	<b>162.903</b>	7703 081 184
25	Taco fijac. tapizados puerta Megane, Kangoo, Espace, Master '81	<b>162.933</b>	7703 081 176
25	Taco fijac. revestimientos interiores varios modelos (ver Dacia, Fiat, Opel, PSA)	<b>163.222</b>	7703 081 185
50	Taco fijac. embellecedor exterior puerta Laguna III, Latitude, Megane III, Fluence, fijac.armazón delantero Twingo	<b>163.426</b>	7703 081 160
50	Taco fijac.armazón delantero Twingo	<b>163.427</b>	7703 081 163
50	Taco fijac.tapizados interiores Megane II, fijac. talonera Kangoo II, fijac. moldura puerta Laguna III (ver PSA)	<b>163.502</b>	7703 081 164
50	Taco fijac. moldura parabrisas Scenic III (ver PSA)	<b>163.881</b>	7700 081 233
10	Taco fijac. inferior moldura parabrisas Megane III Coupé, fijac. panel puerta Megane III, Scenic III	<b>163.882</b>	7703 081 232
10	Taco fijac.tapizados interiores Laguna III, Megane III, Scenic III	<b>163.883</b>	7703 081 225





U.E.	DESCRIPCION	Ref. Adaptable
100	Remache fijac. pasoruada R-4, R-5, R-9, R-11, Super-5, Express, Master, Traffic, Espace (ver Mercedes)	162.259 7703 072 144
50	Remache fijac. varios usos Super-5, Express (ver Fiat, Mercedes, PSA, VAG)	162.424 7703 072 220
50	Remache fijac. revestim. interiores R-5, R-19, Super-5, Express (ver BMW, Mercedes, PSA, VAG)	162.456 7703 072 116
50	Remache fijac. junta puerta Laguna III, y otros usos R-19, R-21, Super-5, Express, Kangoo, Laguna (ver PSA)	162.481 7703 072 236
100	Remache fijac. varios usos Renault	162.647
50	Remache fijac. embellecedor exterior del retrovisor Twingo II (ver Opel)	162.819 7703 072 172
50	Fij. aletas y rejilla calandra Clio III, Espace IV, Fluence, Laguna III, Megane III, Scenic III, Master III, fijac. pasoruada y parachoques Clio III, Kangoo II, Laguna III, Megane II, Scenic II, Master III '10->, fijac. tapizados interiores Clio II, Espace IV, Laguna II, Vel Satis (ver Dacia, Nissan, Opel)	163.088 7703 072 360 054000001R
50	Remache fijac. revestimientos interiores Scenic (ver Ford, VAG)	163.091 7701 049 271
50	Remache fijac. rejilla calandra Clio III, Laguna III, Latitude, Traffic II, fijac. pasoruada Megane II, fijac. moldura superior aleta Twingo II, fijac. tapiz. interiores Renault varios modelos (ver Dacia, Fiat, Nissan, Opel)	163.140 7703 072 361
25	Remache fijac. portón trasero puerta Clio II, Clio III, Laguna, Megane II, Scenic II	163.226 - sin despiece -
50	Remache fijac. varios usos (ver Ford, VAG)	163.306 7703 072 502
25	Remache fijac. rejilla calandra y tapizados interiores Traffic II, fijac. moldura portón Espace IV	163.328 7703 072 352
10	Remache fijac. parachoques Twingo y otros usos Clio I, Espace IV, Vel Satis	163.384 7703 072 345
25	Remache fijac. tapizados interiores Kangoo	163.448
25	Remache fijac. tapizados interiores Laguna II, Scenic II	163.449
50	Remache fijac. varios usos (ver PSA)	163.486 7703 072 327
50	Remache fijac. varios usos (ver Mercedes, PSA)	163.487 7703 072 261



190.369\*



163.656\* - Dcho.  
163.657\* - Izdo.



163.658\* - Dcho./Izdo.

\* (imagen 1/2 tamaño real)



163.169



163.035



163.036



163.037



162.947



163.123



163.333



163.639



163.131



163.132

U.E.	DESCRIPCION	Ref. Adaptable
25	Fijac. moldura parabrisas Rover 200/400 (ver Honda) (Eurocode 7016ASCHB)	162.947 DCC 10010
10	Fijac. pasoruada Rover 400 (ver Honda)	163.035
10	Fijac. parrilla parabrisas Rover 400 '95->, Rover 600 (Eurocode 3936ASCHB/7020ASCSS4B) (ver Honda)	163.036 91508-SM4-003
10	Fij. parachoques Rover 25, fijac. pasoruada Rover 75, fijac. revestimiento parachoques Rover 400 (ver BMW, Daewoo, Honda, Mini)	163.037 DYQ 100230 DYQ 100230A
25	Fijac. moldura parabrisas Rover 400, 45, MG ZS (Eurocode 3940/3948ASCS/ASCCTS7B) (ver Honda)	163.123 91520-SR3-003
10	Fijac. moldura parabrisas Rover 400, 45 y MG ZS (Eurocode 3954ASCH) (ver Honda)	163.131 DCC 100190
10	Fijac. moldura parabrisas Rover 600 (Eurocode 3936ASCSS6B) (ver Honda)	163.132 91525-SM4-003
10	Fijac. talonera puerta Rover 45- (ver Honda)	163.169 DCC 100190
25	Fijación moldura parabrisas Range Rover '95 y 2000 New Style (Eurocode 7024ASCR)	163.333 DCE 10038L
25	Fijación moldura parabrisas Range Rover 2002 (Eurocode 7033ASCRS)	163.639 DYC 500020
1	Soporte cristal elevalunas delantero derecho Land Rover Freelander	163.656 ●
1	Soporte cristal elevalunas delantero izquierdo Land Rover Freelander	163.657 ●
1	Soporte cristal elevalunas trasero derecho e izquierdo Land Rover Freelander	163.658 ●
1	Bomba lavaparabrisas Land Rover Discovery, Range Rover	190.369 ●

# SEAT (antiguos)



\* (imagen NO a tamaño real)



U.E.	DESCRIPCION	Ref. Adaptable
25	Fijac. molduras laterales 600/850	161.425 BD-59039600
10	Tornillo fijac. parachoques Panda (Ø 6 mm.)	161.430 SE-141563390A
50	Tornillo fijac. placa matrícula 127	161.431 NR-17670101
10	Tornillo para resbalón 127	161.440 NR-13325821
50	Fijac. manecilla alzacrystales 600, 124, 127 (ver Fiat)	161.448 FA-52143600
10	Fijac. varilla capó Panda (ver Fiat)	162.273
25	Tornillo fijac. parachoques Panda (Ø 6 mm.) (ver Fiat)	162.356
25	Tornillo fijac. parachoques Panda (Ø 8 mm.) (ver Fiat)	162.357
25	Tuerca fij. parachoques Panda, Ritmo (monta con 162.363) (ver Fiat)	162.359
25	Tornillo fij. parachoques Panda, Ritmo (monta con 162.359) (ver Fiat)	162.363
10	Fijac. (c/inserto zincado) guardabarros Ritmo, Panda	162.364
10	Fijac. (c/inserto zincado) guardabarros Ritmo, Panda (ver Fiat)	162.393
25	Bloqueador tornillo 131	162.564 NR-14219290
10	Tope (goma) capó Seat	164.378
-	Tirante bandeja posterior Panda, Ritmo (long.total 400 mm.)	181.403
5	Surtidor lavaparabrisas Seat 127	190.021 4400321
5	Surtidor lavaparabrisas Seat Panda	190.022 4432041



162.563



162.605



162.428



162.427



162.360



162.557



162.679



162.538



162.520



162.532



162.568



162.541



162.571



162.542



162.640



162.641

U.E.	DESCRIPCION		Ref. Adaptable
25	Fijac. moldura lateral Fura, Panda	162.360	00.05940037
25	Fijac. reenvío manecilla Ritmo, Panda, Marbella (ver Fiat)	162.427	NR-14578083
25	Fijac. moldura talonera 850, 1430	162.428	
10	Fijac. tubo freno Seat (Ø 7 / 7)	162.520	00.04442520
10	Fijac. tubos Seat (Ø 8)	162.532	00.04472197
10	Fijac. tubo freno Seat	162.538	
25	Fijac. punta parachoques 131	162.541	
10	Tapón carrocería Panda	162.542	
25	Fijac. molduras Seat	162.557	
25	Fijac. moldura lateral 131 Supermirafiori	162.563	4401310
25	Fijac. cables Ritmo, Ibiza (Ø 5 / 25)	162.568	00.05978963
10	Fijac. parrilla 131	162.571	JA-53008000
25	Fijac. molduras 131	162.605	
10	Tapón tensor asiento posterior Panda	162.640	00.04424781
10	Tapón taladros Panda	162.641	00.04450794
25	Fijac. molduras 124/127 (ver Fiat)	162.679	FC-59018000

# SEAT (antiguos)

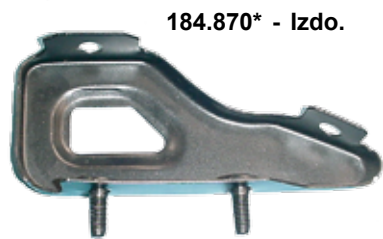

184.870\* - Izdo.

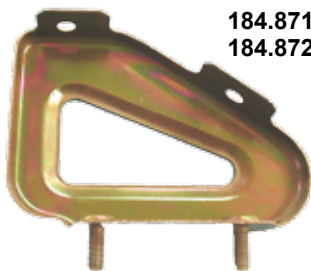

184.871\* - Dcho.  
184.872\* - Izdo.



162.400 \*



162.567 \*

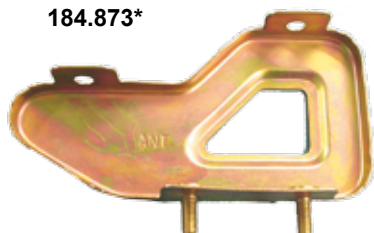

184.873\*

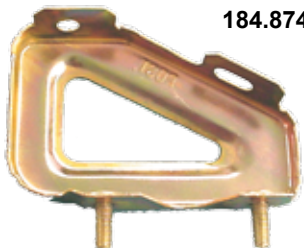

184.874\*



123.742 \* - Dcha  
123.743 \* - Izda.



181.400 \*



181.431 \*



162.653 \*



181.401 \*



181.432 \* - Del. Dcha  
181.433 \* - Del. Izda.  
181.434 \* - Tras. Dcha  
181.435 \* - Tras. Izda.



162.565 \* - Dcho.  
162.566 \* - Izdo.

\* (imagen 1/2 tamaño real)

U.E.	DESCRIPCION	Ref. Adaptable	
-	Tapa bisagra puerta Derecha Panda (modelo '86)	123.742	
-	Tapa bisagra puerta Izquierda Panda (modelo '86)	123.743	
5	Tope parachoques Panda (ver Fiat)	162.400	
5	Bisagra cristal lateral Tras. Dcho. Ibiza hasta '92 (3 puertas)	162.565	
5	Bisagra cristal lateral Tras. Izdo. Ibiza hasta '92 (3 puertas)	162.566	
5	Tope parachoques Ibiza, Toledo	162.567	
5	Bisagra cristal lateral 127, 131, Panda (ver Fiat)	162.653	
-	Guía sujeta cristal Panda (largo: 68 cm.)	181.400	4483981
-	Guía sujeta cristal 127 2 puertas (largo: 37 cm.)	181.401	4255534
-	Guía sujeta cristal Ibiza 3 puertas, Delantera (largo: 33 cm.)	181.431	SE-021521358A
-	Guía sujeta cristal Ibiza 5 puertas, Delantera Derecha (largo: 30 cm.)	181.432	SE-021521358B
-	Guía sujeta cristal Ibiza 5 puertas, Delantera Izquierda (largo: 30 cm.)	181.433	SE-021521359A
-	Guía sujeta cristal Ibiza 5 puertas, Trasera Derecha (largo: 30 cm.)	181.434	SE-021522358A
-	Guía sujeta cristal Ibiza 5 puertas, Trasera Izquierda (largo: 30 cm.)	181.435	SE-021522359A
1	Soporte parachoques delantero Panda - Izquierdo	184.870	
1	Soporte parachoques trasero Panda - Derecho	184.871	
1	Soporte parachoques trasero Panda - Izquierdo	184.872	
1	Soporte parachoques delantero Panda moderno - ambos lados -	184.873	
1	Soporte parachoques trasero Panda moderno - ambos lados -	184.874	



162.307



162.598



162.405



162.402



162.553



162.554



162.551



162.493



162.325



162.713



162.378



162.599



162.615



162.823

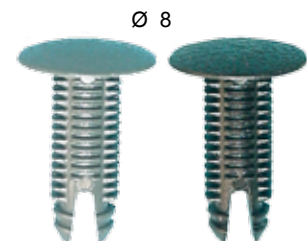

162.579 - Gris  
162.580 - Negro

U.E.	DESCRIPCION	Ref. Adaptable	
10	Fijac. cristal Panda	162.307	
25	Fijac. aislante motor 124, 131	162.325	FC-55609200
100	Fijac. panel puerta 127, 131, Ritmo (ver Fiat)	162.378	NR-14187480
100	Fijac. panel puerta Panda	162.402	
50	Fijac. panel puerta Panda (último) (ver Ford)	162.405	
100	Fijac. tapizados Seat - varios modelos - (ver Fiat)	162.493	NR-14592587
50	Tapón carrocería Seat	162.551	00.04432192
50	Fijac. panel puerta Seat - varios modelos - (color blanco)	162.553	NR-14187980
50	Fijac. panel puerta 131, Ritmo 2ª serie (color amarillo) (ver Mercedes)	162.554	00.92310243
100	Fijac. tapizados interiores Panda (Gris)	162.579	
100	Fijac. tapizados interiores Panda (Negro)	162.580	00.08235646
50	Fijac. panel puerta Ritmo, 132 (ver Fiat)	162.598	GA-55819410
25	Contrabroche panel Panda	162.599	00.04412934
10	Fijac. tapizados Ritmo	162.615	00.04461409
25	Fijac. panel puerta 127	162.713	00.05938663
100	Fijac. tapizados Seat (ver Renault)	162.823	

# SEAT (antiguos)



U.E.	DESCRIPCION	Ref. Adaptable
100	Tuerca rápida varios usos Seat (ver Fiat, Ford, Mercedes, Renault)	162.238 NR-14201980
100	Tuerca rápida varios usos 131, Ritmo (Ver Fiat)	162.240
50	Fijac. faro delantero 127 y trasero Panda	162.241
25	Fijac. varios usos 127, Panda (ver Fiat)	162.242 NR-14202782
25	Fijac. varios usos 127, Panda (ver Fiat)	162.243 NR-14202985
50	Fijac. faro 127, 131, Ritmo (ver Fiat)	162.247 NG-20502815
50	Fijac. faro 127, 131, Ritmo (ver Fiat)	162.248
100	Tuerca rápida varios usos Seat (ver Fiat)	162.326 NR-14215480
50	Fijac. parrilla delantera 127, 131, 132	162.401 HH-53008000
25	Grapa fijación rápida 3 mm. varios usos Seat	162.449 NR-14188880
25	Fijac. tapicería 127	162.457 NR-14203080
25	Fijac. luz matrícula 127, 132, 133	162.491 HB-93981000
25	Fijac. autoroscante Seat - varios modelos -	162.492 NR-14199688
25	Regulador faro 127, 131, 132, Ritmo	162.494 NG-01746109
25	Fijac. tubos universal Seat	162.499
25	Fijac. faro delantero Panda (ver Fiat)	162.533
50	Tuerca rápida varios usos Seat (ver Fiat)	162.534 NR-14202383
50	Fijac. autoroscante rejilla 127, Panda (ver Fiat)	162.545 NR-14203680
25	Fijac. cables faro a rejilla Ibiza	162.558 NR-14574790
25	Fijac. tubos Seat	162.608 00.04292588
50	Fijac. placa matrícula, modelos antiguos	162.609 HB-56625000
25	Fijac. letreros 131	162.610 LF-89016600



190.355\*



173.080



163.339



163.044

\* (imagen 1/2 tamaño real)

U.E.	DESCRIPCION	Ref. Adaptable	
50	Fijac. talonera puerta (ver BMW, Mercedes, Mini, VAG)	163.044	
10	Fijac. parachoques Smart ForTwo	163.339	0001781V002000
1	Bomba lavaparabrisas Smart (ver BMW, Mercedes, Skoda -VAG-)	190.355	
1	Regulador eléctrico faro Smart ForTwo (ver Fiat, Ford, VAG)	173.080	



190.363\*



163.479



163.300



163.276



163.477



163.478

\* (imagen 1/2 tamaño real)

U.E.	DESCRIPCION	Ref. Adaptable	
10	Fijac. varios usos Subaru (ver Nissan)	163.276	57728AC090
10	Fijac. rejilla parabrisas "torpedo" Justy II (ver Suzuki, Toyota, Volvo)	163.300	
10	Fijac. rejilla radiador Subaru	163.477	91017AA010
10	Fijac. rejilla radiador Subaru	163.478	91017FA080
10	Fijac. moldura parabrisas Subaru Impreza '93->'98, Forrester (Eurocode 7915ASCHS)	163.479	91017FA010
1	Bomba lavaparabrisas Subaru (ver Honda, Hyundai, Kia, Mazda, Mitsubishi, Suzuki, Toyota)	190.363	8533012320 8533035070



(imagen 1/2 tamaño real)



U.E.	DESCRIPCION	Ref. Adaptable
25	Fijac. panel puerta Swift, SX4 '06-> (ver Lexus, PSA, Toyota)	163.161 09409-10312
10	Fijación rejilla parabrisas "torpedo" SX4 '06->, fijac. moldura puerta Grand Vitara (Eurocode 3363ASCR) (ver Fiat, Toyota)	163.248 77553-65D10 77553-65D00
25	Fijac. panel puerta y tapizados interiores - varios modelos - (ver Lexus, Toyota)	163.250 09409-08320-000
10	Fijación rejilla parabrisas "torpedo" Swift y otros usos -varios modelos- (Eurocode 8011ASCH / 8010ASCR) (ver Subaru, Volvo)	163.300 09409-07308-5PK
10	Fijac. tapizados interiores - varios modelos -	163.301 09409-07325-5PK
10	Fijac. tapizados interiores - varios modelos -	163.302 09409-07303-5ES
10	Fijac. tapizados interiores - varios modelos -	163.475 09409-07305-5PK
10	Fijac. parachoques, pasoruada y talonera puerta Aerio/Liana '02, Grand Vitara, Jimny, Swift, SX4 '06 (ver Fiat, Honda, Toyota)	163.476 09409-07332-000
25	Fijac. tapizados interiores - varios modelos -	163.509
25	Fijac. tapizados interiores - varios modelos -	163.510
25	Fijac. tapizados interiores - varios modelos -	163.512
25	Boca fijac. varios usos - varios modelos -	163.513
25	Fijac. tapizados interiores - varios modelos -	163.514
10	Fijac. tapizados - varios modelos - (ver Mazda, Toyota)	163.531 89422-64920
25	Fijac. revestimientos interiores Jimny, Vitara, Gran Vitara, fijac. spoiler Jimny fijac. parachoques delantero Gran Vitara, Swift,	163.616 09409-08322-000
10	Fijac. moldura lateral Liana, Vitara, Gran Vitara	163.617 09409-10309-000
25	Fijac. talonera puerta Aerio/Liana '02->, Swift, SX4 '06-> (ver Fiat)	163.814 09409-15302-000
10	Fijac. moldura inferior parabrisas Swift, SX4 '06-> (Eurocode 6291ASCV) (ver Fiat, Opel)	163.852 84618-76G10
10	Fijac. moldura lateral parabrisas Swift '05-> (Eurocode 8031ASCCHS / 8032ASCCHS)	163.866 77150-63J10
1	Bomba lavaparabrisas varios modelos (ver Honda, Hyundai, Mazda, Mitsubishi, Subaru, Toyota)	190.363
1	Bomba lavaparabrisas Swift, Vitara '97, Gran Vitara, Samurai '99 (ver Daewoo, Ford, Honda, Hyundai, Mitsubishi, Toyota)	190.365 38410-66113



190.365\*



190.363\*



190.041



163.130

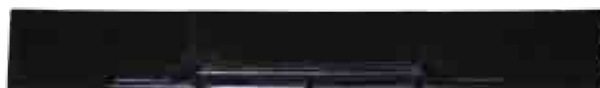

163.706

Ø 6,5



163.122



163.159



163.859



163.359



163.650



163.895



163.246



163.352\* - Dcho.  
163.353\* - Izdo.

\* (imagen 1/2 tamaño real)

U.E.	DESCRIPCION	Ref. Adaptable
10	Fijac. rejilla radiador Toyota Auris, Avensis, Celica, Corolla, IQ, Prius, Starlet, Yaris	163.122 67867-12150
10	Fijac. moldura parabrisas Toyota Camry '91->'96, Carina ->'92 (Eurocode 8262ASCH)	163.130 75548-20110
25	Fijac. parrilla radiador Celica, Corolla, HiLux, Land Cruiser ->'01 (ver Honda, Mazda, Opel)	163.159 90467-12020
5	Fijac. parrilla radiador Rav 4 '00->'05	163.246 53145-42010
1	Soporte faro delantero derecho Yaris '99->'05	163.352 52535-52012
1	Soporte faro delantero izquierdo Yaris '99->'05	163.353 52536-52012
10	Fijac. moldura parabrisas Toyota Avensis '03->'08, Aygo, Camry, Celica, Corolla '01->'06, IQ, Land Cruiser, Prius, Rav 4 '00 y '05, Yaris '99 y '05-> (Eurocode 8310ASCH) (ver Lexus)	163.359 56115-30100
10	Fijac. moldura lateral parabrisas Land Cruiser Prado '09-> (Eurocode 8371ASCSS) (ver Lexus)	163.650 75545-53010
10	Fijac. moldura superior parabr. Toyota Auris, Avensis '03->, Aygo, Camry, Celica, Corolla '01, Verso, IQ, Land Cruiser, Prius, Rav 4 '00->, Urban Cruiser, Yaris (Eurocode 8310ASCH6B) (ver Lexus)	163.706 56116-22050
10	Fijac. rejilla parabrisas "torpedo" Avensis '97->'03 (Eurocode 8305ASCH6B)	163.859 90467-07188
10	Fijac. parachoques trasero Yaris '99->'05	163.895 52565-52010
5	Surtidor lavaparabrisas Aygo (ver PSA)	190.041
1	Bomba lavaparabr. varios modelos (ver Honda, Hyundai, Kia, Mazda, Mitsubishi, Subaru, Suzuki)	190.363 85310-22080
1	Bomba lavaparabrisas Land Cruiser, Prius, Rav 4 (ver Daewoo, Ford, Honda, Hyundai, Mitsubishi, Suzuki)	190.365 38410-66113



U.E.	DESCRIPCION	Ref.	Adaptable
10	Fijac. pasoruada Toyota Celica, Corolla, Corona Land Cruiser ->'89	163.121	90189-06003
25	Fijac. pasoruada y parachoques Auris, Corolla, IQ, Prius '09->, Yaris (ver Lexus)	163.165	90189-06013
10	Fijac. moldura pasoruada trasero Rav 4 '00->'05	163.247	75494-42010
10	Fijac. parachoques y portón trasero Rav 4 '94->'05, fijac. portón trasero Yaris Verso '99->'05 (ver Fiat, Suzuki)	163.248	90467-11063
25	Fijac. revestimientos interiores Avensis '03->'08, IQ, Paseo, Verso-S, Yaris	163.254	90467-10023
25	Fijac. tapizados portón trasero Land Cruiser ->'07 y otros usos - varios modelos -	163.255	90189-06005
25	Fijac. pasoruada trasero Aygo, Corolla, Prius, Verso-S, Yaris, fij. talonera puerta Celica, Corolla '01	163.256	90189-06006
10	Fijac. tapizados interiores - varios - (ver Honda, Mazda, Nissan)	163.520	90189-06042
10	Fijac. revestimientos interiores - varios modelos - (ver Lexus)	163.526	75397-48030
10	Fijac. revestimientos interiores - varios modelos - (ver Lexus)	163.527	75395-33030
25	Fijac. maneta interior Carina (ver Mazda)	163.619	90189-06010
25	Fijac. moldura guardabarros Corolla	163.622	90189-06226
25	Fijac. parachoques trasero Corolla '01->'06, fijac. bajos carroceria Prius '03->'09	163.894	90189-06224
10	Fijac. moldura portón trasero Rav4 '05->, fij. aleta delantera y moldura lateral Land Cruiser '02->'09	163.931	75397-35010
10	Fijac. moldura aleta trasera Rav4 '94->'00	163.932	75498-42010
10	Fijac. moldura lateral Land Cruiser '02->'09	163.933	75392-60031
10	Fijac. moldura lateral Land Cruiser '02->'09	163.934	75495-35010
10	Fijac. moldura aleta trasera Land Cruiser '02->'09	163.935	75394-60030
10	Fijac. moldura aleta trasera Land Cruiser '02->'09	163.936	75492-60020
10	Fijac. moldura aleta trasera derecha Land Cruiser '02->'09	163.937	75881-60010
10	Fijac. moldura aleta trasera izquierda Land Cruiser '02->'09	163.938	75883-60010
10	Fijac. moldura aleta trasera derecha Land Cruiser '02->'09	163.939	75882-60010
10	Fijac. moldura aleta trasera izquierda Land Cruiser '02->'09	163.940	75884-60010
10	Fijac. moldura aletas Hi-Lux '97->'05 y '05->, fijac. moldura lateral y aletas 4Runner '95->'02	163.941	90904-67037
10	Fijac. moldura aletas Hi-Lux '97->'05 y '05->, fijac. moldura lateral y aletas 4Runner '95->'02	163.942	90904-67036



163.532



163.253



163.162



163.533



163.534



163.531



163.620



163.250



163.161



163.354



163.621



163.528



163.251



163.356



163.535

U.E.	DESCRIPCION	Ref. Adaptable
25	Fijac. tapizados interiores Avensis, Auris, Aygo, Camry, Celica, Corolla, Hilux, IQ, Land Cruiser, MR2, Previa, Rav4, Verso, Yaris (ver Lexus, PSA, Suzuki)	163.161 90467-10161 90467-09206
25	Fijac. moldura base retrovisor y talonera puerta Aygo, Avensis '03, Corolla '01, Yaris '99->'05 y '05-> fijac. aletas y moldura portón trasero Rav 4 '05->, fijac. tapiz. interiores Celica, HiAce (ver Lexus)	163.162 90467-10162
25	Fijac. panel puerta y tapizados interiores Camry, Carina, Celica ->'99, Corolla ->'06, Hi-Lux, HiAce, Land Cruiser ->'07, Paseo, Previa, Prius '00->'03, Starlet, Yaris '99->'05, 4Runner (ver Lexus, Suzuki)	163.250 67771-12050
10	Fijac. moldura portón trasero Avensis '03->'08, Corolla '97->'07, Corolla Verso ->'09 (ver Lexus)	163.251 75819-12040
25	Fijac. panel puerta Carina E, Corolla ->'01, Corolla Verso '01->'03, Yaris '99->'05	163.253 67771-16170
25	Fijac. panel puerta Yaris '99->'05, Picnic, fijac. tapizados interiores Corolla '01, Avensis Verso '01, Land Cruiser	163.354 90467-10192
25	Fijac. tapizados portón trasero Yaris (ver Lexus)	163.356 90467-05096
10	Fijac. moldura portón trasero Land Cruiser '02->'09, moldura ventanilla trasera Corolla ->'97, MR2, Starlet ->'99 (ver Lexus)	163.528 62955-12010
10	Fijac. tapizados interiores Celica, Corolla, HiAce, HiLux, Land Cruiser (modelos antiguos) (ver Mazda, Suzuki)	163.531 67771-12010 67771-01010
10	Fijac. tapizados interiores Celica, MR2, Picnic, Previa, Starlet, HiLux '97->'05, Land Cruiser '90->'07	163.532 67921-95501
10	Fijac. tapizados Camry, Cressida, MR2, Starlet, Land Cruiser ->'89	163.533 67771-22010
10	Fijac. parachoques y pasoruada trasero Land Cruiser Prado '02->'09	163.534 75493-60020
25	Fijac. tapizados - varios modelos -	163.535 90467-09084-01
10	Fijación tapizados interiores y panel puerta Avensis '97->'02, Corolla '97->'01, HiAce '95->, Land Cruiser '96->'02, MR2, Picnic, Previa, Prius '00->'03, Rav4 '94->'00, Yaris '99->'05	163.620 67771-30070
10	Fijac. tapizados interiores Auris '07, Camry '06->, Celica, Corolla '06->, IQ '08->, Land Cruiser '07->, Prius '09, Rav4 '00, Urban Cruiser '09, Verso-S, Yaris '05->, fijac. portón trasero Avensis '97->'08, Corolla '97->'06, fijac. moldura techo Avensis '08-> (ver Lexus)	163.621 90467-10167



163.523\*



163.524\*



163.525\*



163.160

Ø 5



163.262

Ø 6



163.259

Ø 6



163.260

Ø 6



163.261

Ø 7



163.258

Ø 7



163.194

Ø 7



163.252

Ø 7



163.193

Ø 7



163.257

Ø 7



163.357



163.536



163.355

\* (imagen 1/2 tamaño real)

U.E.	DESCRIPCION	Ref. Adaptable
10	Fij. moldura pasoruada Camry, Carina, Celica ->'99, Corolla ->'97, MR2, Previa, Tercel (ver Lexus)	163.160 53879-14010
25	Fijac. insonorizante capó Corolla '97->'06, Land Cruiser Prado '02->'09, Previa, Supra, Verso, Yaris '99->'05 y fijac alfombras Celica '99->'05 (ver Lexus)	163.193 90467-08124
25	Fijac. insonorizante capó Carina, Celica, Land Cruiser, MR2	163.194 90467-10000
25	Fijac. tapizados alfombras Yaris '99->'05, Verso	163.252 90467-10091
10	Fijac. aislamiento capó Cressida, Hi-Lux	163.257 90467-0900401
10	Fijac. aislamiento capó Auris, Avensis '03->'08, Aygo, Camry, Corolla, IQ '08, HiAce, HiLux, Land Cruiser, Prius, Rav4 '05->, Verso, Yaris '05-> (ver Lexus, PSA)	163.258 90467-09050
25	Fijac. goma capó Avensis Verso, Camry, Carina E, Celica, Corolla, Cressida, MR2, Picnic, Prius, Starlet, Verso, Yaris (ver Lexus)	163.259 90467-08011
25	Fijac. goma capó Camry, Celica, Corolla, Land Cruiser ->'01, Starlet	163.260 90467-08030
25	Fijac. varios usos - varios modelos -	163.261 90467-0906901
25	Fijac. varios usos - varios modelos -	163.262 90467-0616101
10	Fijac. junta gomas puerta Yaris '99->'05 y '05->, Yaris Verso, HiLux '05->, Urban Cruiser '09, fijac. parrilla radiador Corolla Verso '04->'09	163.355 67867-52010
10	Fijac. aislamientos capó Celica ->'99, Rav4 '00->'05	163.357 90467-08081
2	Fijac. parachoques trasero Carina E T19 '92->'97	163.523 52155-21020
2	Fijac. parachoques trasero Carina E T19 '92->'97	163.524 52155-21010
2	Fijac. parachoques trasero Picnic XM10 '96->'01	163.525 52155-44010
25	Fijac. goma capó Yaris '99->'05, Yaris Verso, HiLux '05->, Land Cruiser '96->'02 y '02->'09	163.536 90467-07175



U.E.	DESCRIPCION	Ref. Adaptable
10	Fijac. parachoques Previa, Starlet, Verso, Yaris, fijac. pasoruada Verso, HiLux '97->'05, fijac. portón trasero Rav4 '00, fijac. spoiler parachoques delantero Celica '99->'05, Corolla '97->'01, fijac. parrilla radiador Aygo, Yaris Verso (ver Lexus, Nissan, PSA)	163.166 90467-08185
10	Fij. moldura pasoruada Avensis Verso ->'09, Camry '06, Corolla '97->'06, Corolla Verso '09, Picnic, Previa, Starlet, Yaris '99-> y '05->, Yaris Verso, HiAce, fijac. spoiler trasero Aygo (ver PSA, Lexus)	163.167 90467-07166
10	Fij. moldura pasoruada Rav 4 '00->'05, Land Cruiser '96->'07, fij. rejilla radiador Avensis Verso '01 (ver Lexus)	163.249 53879-60010
25	Fijac. rejilla radiador Yaris '99->'05	163.295 90467-06198
10	Fijac. parachoques Avensis ->'02, Carina, Celica, Corolla '92->'07, Corolla Verso ->'09 (ver Lexus)	163.296 90467-09093
10	Fijac. protectores de parachoques y pasoruada Land Cruiser '96->'02 y '02->'09 (ver Lexus)	163.297 90467-09189
10	Fijac. varios usos HiLux, MR2 (ver Subaru, Suzuki, Volvo)	163.300 90467-07041
10	Fijac. parachoques delantero y trasero y rejilla radiador Auris, Avensis '08->, Camry '96->'01, Celica, Corolla '01->'06 y '06->, IQ '08, Prius, '00->'09 y '09->, Verso-S '10->, Yaris '99->'05 y '05->, Yaris Verso, fijac. parachoques trasero Avensis '97->'08, Aygo, Urban Cruiser '09 (ver Lexus, PSA)	163.358 52161-16010
10	Fijac. pasoruada Auris, Avensis '97->'02 y '08->, Camry, Corolla '01->'06 y '06->, Corolla Verso '09->, IQ '08, HiAce, Previa, Prius '03->'09, Yaris '99->'05 y '05->, Yaris Verso, fijac. bajos carrocería Avensis Verso '01->'09, Celica '99->'05, MR2, Rav4 '00->'05 (ver Fiat, Honda, Lexus, Suzuki)	163.476 90467-07164
10	Fijac. pasoruada y parachoques Corolla -> '95, otros usos HiLux, 4Runner (ver Hyundai, Mazda)	163.503 90467-06017
10	Fijac. moldura pasoruada Auris, Avensis '03->'08 y '08->, Aygo, Corolla '06, Corolla Verso, Yaris '99, Rav4 '05, fij. bajos carrocería Auris, Avensis '03, Corolla '01, Prius '09, Rav4 '05 (ver PSA, Lexus)	163.529 90467-07201
10	Fijac. bajos carrocería Auris, Avensis '08, Corolla Verso '09, fijac. aleta Yaris ->'05, Yaris Verso (ver Lexus)	163.530 90467-07183
10	Fijac. talonera puerta 4Runner '06->, fijación rejilla parabrisas "torpedo" Avensis '97->'03 (Eurocode 8305ASCH6B)	163.859 90467-07188
10	Fijac. pasoruada delantero Avensis '03->'08, fijac. deflector aire delantero Aygo (ver Lexus, PSA)	163.981 90467-09128

# V.A.G. (AUDI / SEAT / SKODA / VW)

Ø 4,2 x 17  
arandela Ø 14



162.702

Ø 4,8 x 15



161.477

Ø 4,8 x 15  
arandela Ø 15



161.473

Ø 4,8 x 18  
arandela Ø 15



161.474

Ø 5 x 16



161.764

Ø 5,5 x 19  
arandela Ø 18



162.555

Ø 5,5 x 19  
arandela Ø 22



161.742

Ø 6,3 x 19  
arandela Ø 18



162.556

Ø 6,3 x 19  
arandela Ø 22



161.743

Ø M6 x 19



161.486

Ø M6 x 27



162.397

Ø 3,2 x 6

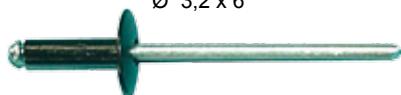

161.650

Ø 4 x 14

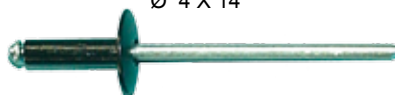

161.653

Ø 2,4 x 5



162.362

U.E.	DESCRIPCION	Ref. Adaptable	
50	Tornillo Ø 4,8 x 15 (aro Ø 15), varios usos (ver BMW, Ford, Mercedes, Opel, PSA)	161.473	
50	Tornillo Ø 4,8 x 18 (aro Ø 15), varios usos (ver BMW, Ford, Mercedes, Opel, PSA)	161.474	
50	Tornillo fijac. pasoruada VW Golf III, Golf IV, Passat	161.477	N 907 750 01
10	Tornillo fijac. parachoques trasero VW Golf IV (ver PSA)	161.486	6N0 807 199
100	Remache Ø 3,2 x 6, varios usos V.A.G.	161.650	N 906 349 01
100	Remache Ø 4 x 14, paso rueda y spoiler VW Golf	161.653	
50	Tornillo Ø 5,5 x 19 (aro Ø 22), sujeción guardabarros (ver BMW, Ford, Mercedes, Opel)	161.742	
50	Tornillo Ø 6,3 x 19 (aro Ø 22), sujeción guardabarros (ver BMW, Ford, Mercedes, Opel)	161.743	
25	Tornillo Ø 5 x 16, fijac. pasoruada y parachoques VW Caddy '04, Golf V, Phaeton, Touran, fijac. moldura puerta VW Passat '97, fijac. parachoques Seat Cordoba '03, VW Polo '02, y otros usos Audi A4, A6, A8, TT, VW New Beetle	161.764	N 103 546 01
50	Remache Ø 2,4 x 5, varias aplicaciones (ver Fiat, Ford, Opel, PSA, Renault)	162.362	
10	Tornillo fijac. parachoques delantero y trasero Seat Ibiza'93, Córdoba, VW Golf IV	162.397	6N0 807 199 N 907 407 01
50	Tornillo Ø 5,5 x 19 (aro Ø 18), sujeción guardabarros (ver Ford, Opel)	162.555	
50	Tornillo Ø 6,3 x 19 (aro Ø 18), sujeción guardabarros (ver BMW, Ford, Mercedes, Opel)	162.556	311 821 143 N 905 426 02
25	Tornillo Ø 4,2 x 17 (aro Ø 14), fijac. pasoruada y revestimientos - varios modelos - (ver Renault)	162.702	N 103 091 01



161.765



161.482



161.768



161.766



163.071

Tornillo Ø 4,2



161.459

Tornillo Ø 6,3



161.460

Tornillo Ø 6,3



161.755



161.735

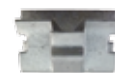

161.770



161.429



162.711



162.712



162.904

cabeza Ø 14  
agujero Ø 7  
tornillo Ø 5



163.372

cabeza Ø 13  
agujero Ø 7  
tornillo Ø 5



163.544

U.E.	DESCRIPCION		Ref. Adaptable
50	Tuerca fijac. altavoces V.A.G.	161.429	N 0386021
25	Tuerca fijac. moldura cristal puerta Audi A3, A4, Skoda Superb '02, VW Caddy '04, Golf V, Lupo, Passat '00, Polo '01, Touran (ver Fiat)	161.459	N 90257703
25	Tuerca fijac. guardabarros VW Golf, Polo '95 (monta con 162.556)	161.460	N 012 062 2
25	Fijac. revestimientos portón trasero Audi A2, A3, Seat Ibiza, Skoda Fabia, VW Golf IV, Polo '02->	161.482	4B0 867 276 A
50	Fijac. revestimientos puerta (apoyabrazos) Seat Altea, Ibiza '02, León '99 y '05, Toledo '99 y '05, VW Golf IV y V, Passat '97, Polo '02	161.735	N 907 468 01
50	Fijac. aleta delantera VW Golf IV	161.755	N 103 055 02
25	Fijac. moldura portón maletero VW Bora, Golf IV, V y VI, Passat '05, Tiguan, Touran	161.765	1J6 867 276
25	Fijac. moldura estribera, panel puerta y otros usos interiores Audi A3 '04->, A4 '01->., A5, A6 '05->, Q5, Q7, TT, Seat Alhambra '03->, Altea, Ibiza / Cordoba '02, León '05, Toledo '05, Skoda Fabia, Octavia '04, Superb '08, VW Golf IV '03->, V y VI, EOS, Jetta, New Beetle Cabrio, Polo '02->, Sharan '01->, Tiguan, Transporter '03->	161.766	1J0 858 137 B 1J0 858 137 A
25	Fijac. revestimientos maletero VW Bora, Golf IV, Touran	161.768	1J9 867 981
50	Fijac. revestimientos puerta Seat Ibiza '09, León '05	161.770	1P0 864 247
25	Tuerca c/aro móvil ( Ø 6 ), varios usos (ver Ford, Opel, PSA, Renault)	162.711	
25	Tuerca c/aro móvil ( Ø 8 ), varios usos (ver Ford, Opel, PSA, Renault)	162.712	
10	Fijac. rejilla a parachoques delantero VW Polo '95	162.904	N 902 184 01
25	Fijac. manecilla respaldo VW Golf IV, Polo, Passat	163.071	311 881 247
10	Boca fijac. matrícula VW Golf III	163.372	N 906 261 01
10	Boca fijac. tapizados Seat Alhambra, Skoda Fabia. Octavia, VW Golf III, Polo, Sharan, Touran	163.544	N 904 792 01





U.E.	DESCRIPCION		Ref. Adaptable
50	Clip fijac. pasoruada Golf y varios usos Ibiza, Toledo	<b>161.418</b>	N 901 708 01
50	Clip fijac. varios usos VAG (ver BMW, Opel, Renault)	<b>161.427</b>	N 902 689 01
50	Clip fijac. frontal Golf III	<b>161.465</b>	N 015 432 2
50	Clip fijac. tapizados portón trasero Polo 2002, fijac. parrilla radiador Transporter IV, fijac. otros usos VAG	<b>161.484</b>	N 015 429 1 N 015 429 2
50	Clip fijac. varios usos VAG	<b>161.489</b>	311 821 161
50	Clip fijac. varios usos VAG	<b>161.491</b>	N 015 458 1
50	Clip fijac. guardabarros delantero VW Golf, Polo'95	<b>161.497</b>	N 901 686 02
50	Clip fijac. varios usos VAG - varios - (ver BMW, Mercedes)	<b>161.498</b>	N 015 445 2
50	Clip fijac. pasoruada Seat León '99, Toledo '99, fijac. parachoques Seat Toledo '91-'99, fijac. otros usos VAG	<b>161.736</b>	N 015 429 1 N 015 422 2
50	Clip fijac. varios usos Audi 80, A3, A6, Seat Alhambra, Arosa, Córdoba, Ibiza, Inca, León, Toledo, Skoda Fabia, Octavia, Superb, VW Caddy, Golf, LT, Lupo, Passat, Polo, Sharan, Transporter	<b>161.737</b>	N 015 439 1
50	Clip fijac. pasoruada Audi A2, fijac. otros usos Audi A3, A4, A6, VW LT, Passat	<b>161.738</b>	N 015 437 3
50	Clip fijac. parachoques Seat Altea, Ibiza/Córdoba '99 y '02->, León '05->, VW Touareg, fijac. pasoruada Audi A3 '03, Seat Altea, Leon '05, fijac. moldura estribera puerta Seat Altea, fijac. bajos carroceria Audi Q5, Seat Altea, Leon '05	<b>161.741</b>	N 908 251 01
50	Clip fijac. varios usos VAG	<b>161.744</b>	N 906 987 03 N 906 987 01
50	Clip fijac. pasoruadas VAG (ver Fiat, PSA, Renault)	<b>162.442</b>	



161.707



161.708



161.712



161.713



161.780



161.709



161.710



161.711



161.772



163.228



163.227



163.319



163.540



163.229



161.461



161.782



163.361

U.E.	DESCRIPCION	Ref. Adaptable
25	Fijac. protectores cárter, protectores térmicos V.A.G. (ver Ford)	161.461 N 903 350 04
10	Tornillo fijac. protector motor/cárter - varios modelos -	161.707 8D0 805 121 B
10	Tornillo fijac. protector motor/cárter - varios modelos -	161.708 8D0 805 121
10	Tuerca fijac. protector motor/cárter - varios modelos -	161.709 8D0 805 960
10	Tuerca fijac. protector motor/cárter Audi 80, 100, Cabriolet	161.710 4A0 805 960
10	Tuerca fijac. protector motor/cárter Audi A4, fijac. parachoques Audi A4, A6	161.711 8E0 805 960
10	Tornillo fijac. protector motor/cárter Audi 80, A8, Cabriolet	161.712 4A0 805 121 B
10	Tornillo fijac. parachoques Audi A4, A6	161.713 8E0 805 121 A
10	Tuerca fijac. protector motor/cárter Audi A4 '08->, A5, Q5 (ver BMW, Mini)	161.772 8K0 805 922 A
10	Tornillo fijac. protector motor/cárter Audi A4 '08->, A5, Q5	161.780 8K0 805 121
25	Fijac. protectores motor/cárter Audi A3, A4, A5, A6, Q5, Q7, Seat Altea, Arosa, Ibiza/Córdoba '02, León '99->'05, Toledo '99->'05, Skoda Fabia, Octavia, Superb, VW Caddy, EOS, Golf IV / V, Lupo, New Beetle, Polo '02, Scirocco '09, Touran, Transporter	161.782 N 907 965 02
25	Tapón protector motor/cárter - varios -	163.227 4A0 805 121 A
25	Tuerca protector motor/cárter - varios -	163.228 4A0 805 163
25	Tuerca fijac. bajos Audi A3, VW Polo ->'02, Golf IV, Golf V	163.229 N 105 791 01
25	Tapón fijac. protector motor/cárter - varios modelos -	163.319 4A0 805 121 C
50	Junta fijac. protector motor/cárter - varios modelos -, fijac. pasoruada Audi 80/100/A6/A8	163.361 4A0 805 137 A
25	Tapón fijac. protector motor/cárter - varios modelos - VW Polo, Golf III, Touran, Sharan	163.540 4F0 805 121



181.410\*



181.405\*

\* (imagen NO a tamaño real)



162.329



162.708



164.379



164.383



164.384



162.854



190.031

U.E.	DESCRIPCION		Ref. Adaptable
10	Tope goma Seat / VW	<b>162.329</b>	
10	Fijac. tirante bandeja posterior VW Golf III (ver PSA)	<b>162.708</b>	
-	Sujeción radiador VW Caravelle, Transporter '91->'04	<b>162.854</b>	701 121 565
5	Tope (goma) capó Seat Alhambra '97, Arosa '97, VW Golf III y IV, Lupo '99, Polo '95, Sharan '96	<b>164.379</b>	1H0 823 499
5	Tope (goma) capó Seat Alhambra '97->'00, Arosa, VW Golf III, Passat '97->'00, Polo '95, Sharan '96	<b>164.383</b>	1H0 823 500 B
-	Tope (plástico/goma) portón Seat Ibiza/Cordoba '97->'02, VW Passat '97->'00, Polo '95->'02	<b>164.384</b>	6N0 827 499
-	Tirante bandeja posterior VW Golf II, Jetta (long.total 265 mm.)	<b>181.405</b>	191 863 447 1H6863447B41
-	Tirante bandeja posterior VW Golf (long.total 330 mm.)	<b>181.410</b>	
5	Surtidor lavaparabrisas Seat Ibiza / Córdoba '93->'99, Inca, León '99-'05, Toledo '99-'04, VW Caddy '96->'04, Golf 3/Vento, Passat ->'97, Polo (6N) '94-'02, Transporter '98->	<b>190.031</b>	191 955 985 A



190.352\*



190.353\*



190.354\*



190.355\*



190.368\*



190.371\*



190.372\*



190.378\*



190.379\*

\* (imagen 1/2 tamaño real)

U.E.	DESCRIPCION	Ref. Adaptable
1	Bomba lavaparabr. Audi 80, 90, 100, VW Caddy, Golf, Polo, Passat, Transporter (ver Mercedes)	190.352 431 955 651
1	Bomba lavaparabrisas Audi A3, A4 '98, A6, Seat Alhambra '00->'06, Arosa, Ibiza/Cordoba '99->'02, Inca, Fabia, Octavia, VW Bora, Golf 4, Polo '95->'02, Passat '97->'00 (ver BMW, Mercedes)	190.353 1J6 955 651
1	Bomba lavaparabrisas Audi 80, 90, 100, A4, A6, A8, Cabrio, S6 quattro	190.354 4A0 955 651 A
1	Bomba lavaparabrisas Audi A2, A3 '09, A4 '01, A5, A6, A8, TT, Seat Ibiza/Cordoba, Inca, León '99, Toledo '99, Skoda Fabia '07, Octavia, Superb, VW Caddy, EOS, Golf V, New Beetle, Passat, Polo ->'02, Transporter (ver BMW, Mercedes, Smart)	190.355 1K5 955 651
1	Bomba lavaparabrisas Seat Alhambra, Córdoba, Ibiza, Inca, VW Golf 3, Passat, Polo, Sharan, Transporter (ver Ford, Opel)	190.368 1H6 955 651
1	Bomba lavaparabrisas VW Passat, Polo, Transporter, LT (ver Mercedes, Opel)	190.371
1	Bomba lavaparabrisas Seat Alhambra, Ibiza '93, Inca '96, VW Caddy '96, Corrado, Golf II y III, Passat ->'04, Polo II y III, Transporter (ver Opel)	190.372
1	Bomba lavaparabrisas Seat Alhambra, Córdoba, Ibiza, Toledo, Skoda Octavia ->'04, VW Golf, Sharan (ver Mercedes, Mini)	190.378 1L0 955 651
1	Bomba lavaparabrisas Seat Alhambra, Córdoba, Ibiza, Inca, León, Toledo, Skoda Octavia '04->, VW Golf, Passat IV '97->'04, Sharan (ver Volvo)	190.379 1K5 955 651

# V.A.G. (AUDI / SEAT / SKODA / VW)



162.295 \*



162.969 \*



163.000 \*



163.001 \*



162.839



162.403



162.317



163.738 \*



163.739 \*

\* (imagen 1/2 tamaño real)

U.E.	DESCRIPCION		Ref. Adaptable
5	Soporte parachoques delantero VW Golf '89	162.295	165 807 193 B
5	Tope parachoques VW Golf, Polo	162.317	171 807 267
10	Tope lateral parachoques VW Golf (ver Fiat)	162.403	191 807 193
10	Inserto para terminación parachoques VW Golf III	162.839	1H9 807 250
5	Soporte lateral parachoques Seat Alhambra, Ibiza '93-'97, VW Golf II y III, Sharan, Passat -> '97	162.969	7M0 807 181 A
2	Soporte parachoques delantero derecho Seat Córdoba '97, Ibiza '97	163.000	6K5 807 184
2	Soporte parachoques delantero izquierdo Seat Córdoba '97, Ibiza '97	163.001	6K5 807 183
10	Refuerzo aleta delantera derecha Seat Ibiza '09->	163.738	6J0 821 120 A 6J0 821 120
10	Refuerzo aleta delantera izquierda Seat Ibiza '09->	163.739	6J0 821 119



163.049



162.763



162.764



163.187



162.834



162.768



162.845



162.846



163.543



163.189



162.840

U.E.	DESCRIPCION		Ref. Adaptable
10	Fijac. derecha rejilla frontal VW Polo '95	162.763	6N0 853 826
10	Fijac. izquierda rejilla frontal VW Polo '95	162.764	6N0 853 825
10	Boca centraje rejilla delantera VW Golf III	162.768	1H0 854 549
10	Boca centraje rejilla delantera VW Golf '84-'92	162.834	165 853 674
10	Fijac. aislamiento capó motor VW Golf III	162.840	1H0 863 850
25	Fijac. insonorizantes capó VAG '92-> (largo 20 mm.)	162.845	1H5 863 849
25	Fijac. insonorizantes capó Seat Alhambra, Ibiza/Córdoba '93, Inca, Skoda Octavia '97->'00, VW Caddy, Golf III, Passat ->'97, Polo ->'02, Sharan (largo 30 mm.)	162.846	867 863 849 A
10	Fijac. parrilla delantera VW Lupo	163.049	6X0 853 575
25	Fijac. embellecedor parrilla radiador Seat Ibiza/Córdoba'95, Inca '98	163.187	6K0 853 129
25	Tapón aisladores acústicos Audi A3 '97->'03, TT '99->'06, VW Bora, Golf IV, Polo '02	163.189	1J0 863 119
25	Fijac. insonoriz. capó Audi A1, A3, A4w, A5, A6, A8, Q5, Q7, TT, VW Passat '11-> (largo 20 mm.)	163.543	8E0 863 727 A



163.004 \*- Dcho.  
163.005 \*- Izdo.

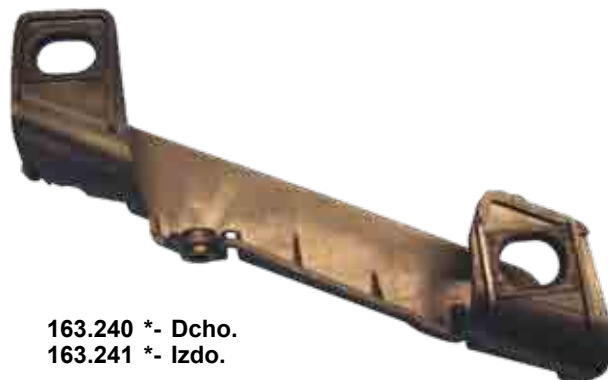

163.240 \*- Dcho.  
163.241 \*- Izdo.



163.236 - Dcho.  
163.237 - Izdo.



163.238 \*- Dcho.  
163.239 \*- Izdo.



163.242 - Dcho./Izdo.

\* (imagen 1/2 tamaño real)



162.506



162.762



163.175

U.E.	DESCRIPCION	Ref. Adaptable
10	Fijac. varilla capó Seat Alhambra '97->'00, VW Golf '92->'98, Passat, Sharan '96->'00	162.506 1H0 823 397
10	Fijac. varilla capó VW Golf IV y V, Polo '95->'00, Bora '99	162.762 6N0 823 397 A 6N0 823 397 C
1	Kit reparación faro derecho VW Golf IV	163.004
1	Kit reparación faro izquierdo VW Golf IV	163.005
10	Fijac. varilla capó Audi 80, 90, 100, Coupé, Seat Altea, Arosa, Córdoba/Ibiza '93->'08 y '08->, Inca, Leon '05, Toledo '92->'09, VW Caddy ->'03, Golf ->'92, LT ->'96, Polo, Transporter '91->'03 y '03->	163.175 357 823 397 6K0 823 397
1	Kit reparación faro derecho VW Polo '02->	163.236 6Q0 998 226
1	Kit reparación faro izquierdo VW Polo '02->	163.237 6Q0 998 225
1	Kit reparación faro derecho VW Lupo '99->'06	163.238 6X0 998 226
1	Kit reparación faro izquierdo VW Lupo '99->'06	163.239 6X0 998 225
1	Kit reparación faro derecho Audi A4 '01->'05	163.240 8E0 998 122
1	Kit reparación faro izquierdo Audi A4 '01->'05	163.241 8E0 998 121
1	Kit reparación faro derecho e izquierdo Audi A3 '97->'03	163.242 8L0 998 121



173.080



173.196



178.098



173.197

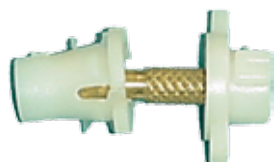

162.292



162.294



162.293



190.382\*

\* (imagen 1/2 tamaño real)

U.E.	DESCRIPCION		Ref. Adaptable
5	Regulador faro VW Golf '90	162.292	191 941 133
5	Regulador faro VW Golf '90	162.293	191 941 141
50	Fijac. regulador faro VW Golf '90 (ver BMW)	162.294	191 941 142
1	Regulador eléctrico faro A3 '03->'08, A4 '05, TT, Seat Alhambra, Skoda Octavia '00, VW Caddy '04, Golf V, LT '04->, New Beetle, Passat '09->, Polo '02->'05, Sharan, Touran, Transporter '03-> (ver Fiat, Ford, Smart)	173.080	1J0 941 295 A
1	Regulador eléctrico faro Audi A2, A4 '99->'04, Q7, Seat Arosa, Ibiza/Cordoba '99->'02 y '02->'08, Leon '99->'05, Toledo '99->'04, VW Golf IV y V, Lupo, Polo '99->'05	173.196	1J0 941 295 B
1	Regulador eléctrico faro Audi A3 '08, VW Crafter '06, Golf V y VI, Jetta, Passat '05, Polo '05, Touareg (ver Opel)	173.197	1K6 941 295
1	Regulador eléctrico faro Audi Q5, Seat Altea, Exeo, Ibiza '09->, Leon '05, Toledo '05, Polo '05-> (ver Opel)	178.098	5P0 941 295
1	Bomba lavafaros -todos los modelos- (ver BMW, Ford)	190.382	3B7 955 681





163.208



163.183



163.190



162.761



162.778



162.929



162.844



163.050



162.504



162.920



163.232



163.231



163.346



163.206



163.824

U.E.	DESCRIPCION	Ref. Adaptable
50	Fijac. guarnecidos contorno capó motor Seat Alhambra '97->'09, Toledo '92->'99, VW Golf '84->'92, Lupo, Polo '02->'05, Sharan '96->'09, LT, Transporter '96->'04	162.504 251 823 717
25	Botón obturación agujeros puerta VW Golf III	162.761 1H0 837 111 A
25	Botón fijac. revestimientos interiores Skoda Fabia '00, Octavia '97, VW Golf III	162.778 N9057400101C
50	Botón + boca fijac. revestimientos contorno puerta VW Golf III (ver Ford, Opel)	162.844 1H0 837 719
50	Fijac. guarnecidos contorno capó motor VW Golf III, Polo '95	162.920 1H0 823 717
25	Botón fijac. tapizados maletero Seat Ibiza/Córdoba '93, fijac. otros usos Seat Toledo '91->'99	162.929 6K6 863 988
50	Fijac. guarnecido contorno capó motor VW Polo	163.050 6K0 823 717
10	Tapón panel puerta Seat Ibiza/Córdoba, VW Polo '95	163.183 867 971 928
25	Tapón desagüe (19,80) Audi A2, A3, A4, A5, A6, Q5, Seat Altea, Ibiza/Cordoba '99->'02, León '99->'05 y '05->, Toledo '99->'09, VW Caddy '04, Golf IV y V, Bora, New Beetle, Passat '97->'05, Scirocco '09, Tiguan, Touran	163.190 893 803 593
50	Fijac. juntas estanqueidad puertas Audi 80, 100, A3, A4, A6, A8, New Beetle Cabrio, fijac. tapizados interiores León '99->'05, Toledo '99->'05	163.206 8L3 837 199 B
25	Tapón desagüe (29,60) Audi A2, A3, A4, A5, A6, A8, Q5, Q7, TT, Seat Ibiza / Cordoba '99, Leon / Toledo '99->'05, Skoda Superb '02, VW Golf IV, New Beetle, Polo Classic '00->'02	163.208 8D0 803 583 L
25	Fijac. juntas estanqueidad puertas Seat Alhambra, VW Sharan (ver Ford)	163.231 7M0 853 585 E
25	Boquilla moldura vierteaguas Audi A4 '01->'08, A6 '05->	163.232 8E5 853 213
50	Fijac. juntas estanqueidad puertas Seat Ibiza/Córdoba '02->	163.346 6L0 839 720 A
25	Fijac. juntas estanqueidad puertas VW Golf V y VI, Jetta '09->	163.824 1K0 837 199 B



162.689



162.690



162.990



162.991



163.709



163.710



163.637



163.850



163.545



162.370



162.759



162.760



163.020



162.765



163.726

U.E.	DESCRIPCION	Ref. Adaptable
50	Fijac. moldura lateral parabrisas Skoda Fabia '07->, Roomster '06-> (Eurocode 7811ASCMS) (ver PSA)	162.370 5J0 853 573
100	Fij. moldura techo Seat Ibiza/Cordoba '93->'99, Inca '96->'01, Toledo '92->'99, VW Caddy '96->'03, Golf '84->'92, Passat '88->'97, Polo Classic '96->'00 (Eurocode 7603ASCSS y 7603ASCH)	162.689 191 853 733 A
100	Fijac. moldura techo VW Golf III '92->'99, Vento (Eurocode 8541ASCH)	162.690 1H0 853 733 B
25	Fijac. rejilla aire a capó VW Golf III '92-'99, Inca (monta con 162.760) (Eurocode 8541ASCBH1)	162.759 1H0 819 055 B
25	Boca fijac. rejilla aire a capó VW Golf III '92->'99, Inca (monta con 162.759)	162.760 1H0 819 946 A
50	Fijac. rejilla parabrisas "torpedo" VW Golf III, Skoda Octavia '97-> (Eurocode 8541ASCHB)	162.765 1H0 819 055 C
10	Fijac. moldura lateral parabrisas Seat Toledo '99->'05, León '99->'05 (Eurocode 7608ASCSS)	162.990 1M0 854 541 A
10	Fijac. moldura lateral parabrisas Seat Toledo '99->'05, León '99->'05 (Eurocode 7608ASCSS1B)	162.991 1M0 854 719 A
25	Fijac. rejilla parabrisas "torpedo" Seat Ibiza/Cordoba '93->'99, Inca '96->'04, VW Caddy '96->'03	163.020 6K0819285 B41
25	Fijac. rejilla parabrisas "torpedo" Seat Altea, Leon '05, Toledo '05-> (Eurocode 7610LSCHRQ)	163.545 6L6 853 575 A 6L6 853 575
50	Fijac. moldura lateral parabrisas Seat León '05-> (Eurocode 7613ASCHS)	163.637 1P0 854 719 B
10	Fijac. moldura lateral parabrisas VW Phaeton, Touareg	163.709 3D5 853 707 B
25	Fijac. moldura parabrisas VW Touran '03->	163.710 1T0 853 910 A
25	Fijac. rejilla parabrisas "torpedo" Alhambra '96->'09, Sharan '96->'05 (Eurocode 3550ASCVB)	163.726 7M3 853 585
50	Fijac. moldura lateral parabrisas Seat Ibiza '09-> (Eurocode 7614ASCHS)	163.850 6J0 854 719 C

# V.A.G. (AUDI / SEAT / SKODA / VW)



163.184\*



163.185\*



163.186\*

\* (imagen 1/2 tamaño real)



163.147



163.148



162.500



163.917



163.929



162.787



162.677



163.955



163.956



162.501



162.502



163.707



162.785



162.786

U.E.	DESCRIPCION	Ref. Adaptable
25	Fijac. moldura piso puerta VW Golf II	162.500 191 853 577
50	Fijac. moldura VW Golf '90, Passat, Jetta, Vento (ver PSA)	162.501 357 853 575
50	Fijac. moldura y protector guardabarros VW Golf '88-'90	162.502 357 853 585 + 357 853 586
25	Fijac. moldura VW Golf	162.677 171 853 585 171 853 585 A
25	Fijac. moldura VW Golf, Passat, Polo, Transporter (monta con 162.786)	162.785 357 853 585 A
25	Boca fijac. moldura VW Golf, Passat (monta con 162.785)	162.786 357 853 586 D
25	Fijac. moldura parabrisas Seat Altea, Toledo '05, fijac. spoiler Seat Ibiza '93, Leon '99->'05, Toledo '99->'05, fijac. moldura a guardabarros VW Golf III, Passat	162.787 191 853 585 A
25	Fijac. moldura bajo puerta (talonera) Audi A3	163.147 8L0 853 909
25	Fijac. moldura bajo puerta (talonera) Audi A4	163.148 8D0 853 909 B
5	Soporte delantero estribera Seat Ibiza/Córdoba '95, Inca'98, VW Caddy '98, Polo '96, Polo '00	163.184 6K0 853 578
5	Soporte central estribera Seat Ibiza/Córdoba '95, Inca'98, VW Caddy '98, Polo '96, Polo '00	163.185 6K0 853 578 A
5	Soporte trasero estribera Seat Ibiza/Córdoba '95, Inca'98, VW Caddy '98, Polo '96, Polo '00	163.186 6K0 853 578 B
25	Fijac. talonera puerta VW Golf V, Phaeton	163.707 3D0 853 576
25	Fijac. moldura lateral puerta VW Scirocco '09, Tiguan, fijac. aletas VW Tiguan fijac. talonera puerta y soporte cubierta portón trasero VW Passat '06	163.917 3C0 853 585
25	Fijac. moldura talonera puerta Audi Q5 '09->	163.929 8R0 853 909 A 8R0 853 909
25	Fijac. talonera puerta Audi A3 '97->'03, Seat Alhambra '00, VW Sharan '00, fijac. revestimientos interiores Altea, Ibiza / Cordoba '02, Leon '99, Toledo '99, Skoda Fabia '00, Octavia '04, VW Caddy '04, Golf IV y V, Jetta, Lupo, Passat '97->'10, Polo '02, Tiguan, Touran, Touareg, Transporter '03 (monta junto con 163956)	163.955 3B0 867 333
25	Fijac. talonera puerta Seat Alhambra '00, VW Sharan '00, fijac. revestimientos interiores Seat Altea, Arosa, Cordoba/Ibiza '02, Leon '99, Toledo '99, Skoda Fabia, Octavia '04, Superb, VW Caddy '04, Golf IV y V, Jetta, Lupo, Passat '97->'10, Polo '02, Tiguan, Touran, Touareg, Transporter '03 (monta junto con 163955)	163.956 3B0 867 334



163.103



162.788



162.789



162.790



162.791



162.301



162.302



162.303



163.394



163.884



163.395



162.792



162.793



162.794



162.795



162.796

U.E.	DESCRIPCION		Ref. Adaptable
10	Fijac. moldura lateral VW Golf III (extremo anterior/posterior)	162.301	1H0 853 585
10	Fijac. moldura lateral VW Golf III (central)	162.302	1H0 853 585 B
10	Fijac. moldura lateral VW Golf III (extremo posterior)	162.303	1H0 853 585 A
10	Fijac. moldura lateral VW Passat '94->'97	162.788	3A0 853 575 A
10	Fijac. moldura lateral VW Passat '97->'04	162.789	3B0 853 575
10	Fijac. moldura lateral VW Passat '94->'97	162.790	3A0 853 575
10	Fijac. moldura lateral VW Passat '97->'04	162.791	3B0 853 576
10	Fijac. moldura lateral Audi A3, A4, A6, A8	162.792	4A0 853 825 C
10	Fijac. moldura lateral Audi A3, A4, A6, A8	162.793	4A0 853 825
10	Fijac. moldura lateral Audi A3, A4, A6, A8	162.794	4A0 853 825 A
10	Fijac. moldura lateral Audi A3, A4, A6, A8	162.795	4A0 853 825 E
10	Fijac. moldura lateral Audi A3, A4, A6, A8	162.796	4A0 853 825 D
10	Fijac. moldura lateral Audi A8 (ver Mercedes)	163.103	4D0 853 825 C
50	Boca fijac. molduras Audi A3, Seat Altea, Leon '99, Toledo '99 y '05->, VW Bora, Golf, Passat '00 (ver BMW, Fiat)	163.394	1H0 853 586
10	Fijac. moldura lateral VW Touareg	163.395	7L0 839 069
50	Boca fijac. moldura talonera puerta VW Golf V, Passat '05, Scirocco '08, Tiguan	163.884	3C0 853 586



163.002 \*

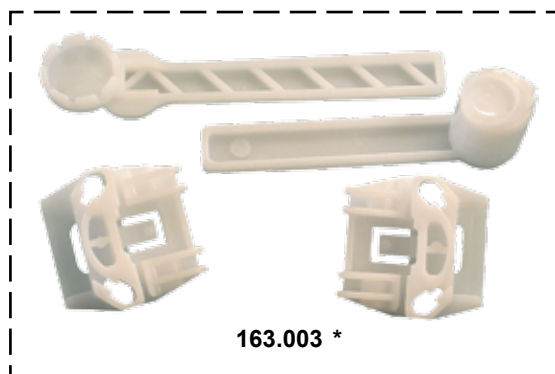

163.003 \*



163.604\* - Dcho.  
163.605\* - Izdo.



163.602\* - Dcho.  
163.603\* - Izdo.

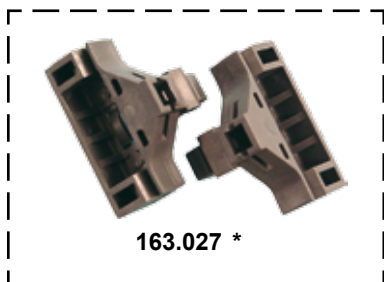

163.027 \*

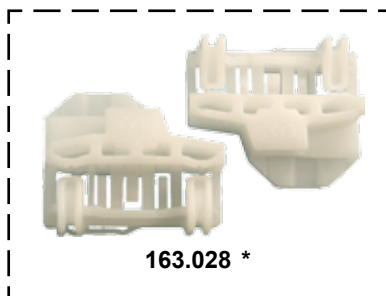

163.028 \*

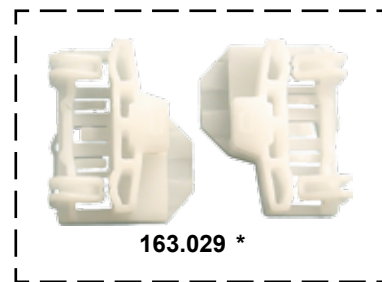

163.029 \*

\* (imagen 1/2 tamaño real)

U.E.	DESCRIPCION	Ref. Adaptable
1	Tensor para kit reparación elevallunas Seat Ibiza, León/Toledo '99, VW Golf IV,	163.002
1	Kit reparación elevallunas VW Golf IV	163.003
1	Kit reparación elevallunas Seat Arosa, Ibiza/Cordoba '93->'01, VW Lupo, Polo '94->'99	163.027
1	Kit reparación elevallunas Audi A4 ->'02, Skoda Superb, VW Passat '97, Polo '99->'01, puerta izquierda	163.028
1	Kit reparación elevallunas Audi A4 ->'02, Skoda Superb, VW Passat '97, Polo '99->'01, puerta derecha	163.029
1	Kit reparación elevallunas delantero derecho VW Golf IV (aluminio)	163.602
1	Kit reparación elevallunas delantero izquierdo VW Golf IV (aluminio)	163.603
1	Soporte cristal elevallunas trasero derecho VW Golf IV	163.604
1	Soporte cristal elevallunas trasero izquierdo VW Golf IV	163.605

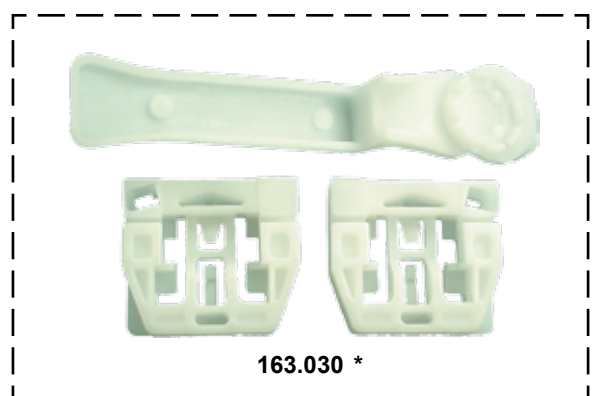
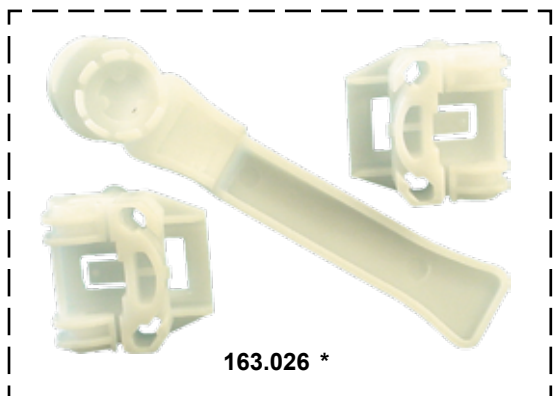
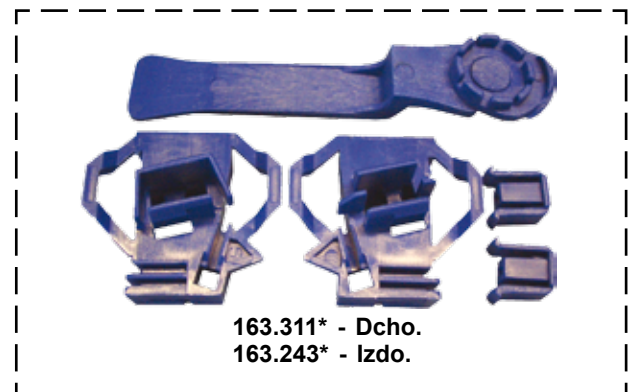
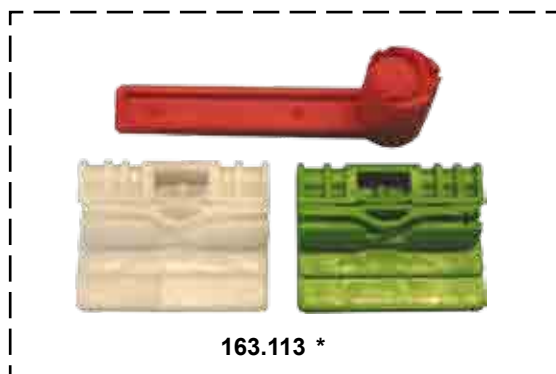
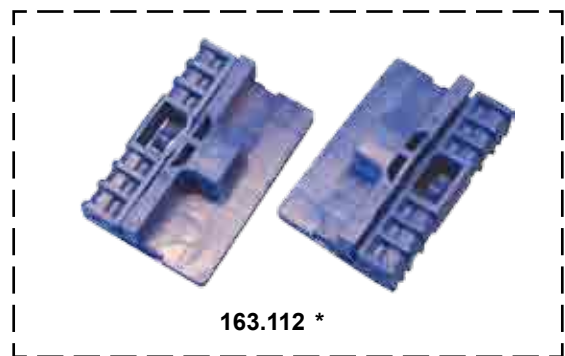
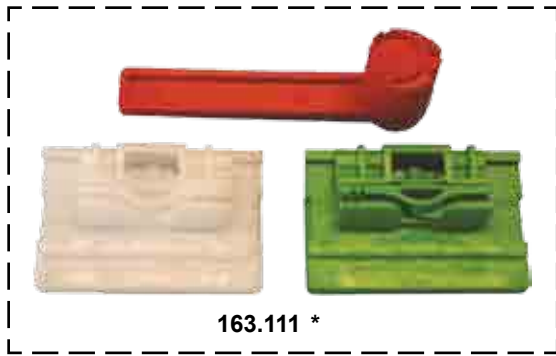

\* (imagen 1/2 tamaño real)

U.E.	DESCRIPCION	Ref. Adaptable
1	Kit reparación elevalunas Seat Ibiza, León/Toledo '99->'04, Skoda Fabia, VW New Beetle	163.026
1	Kit reparación elevalunas Skoda Octavia	163.030
1	Tensor para kit reparación elevalunas Skoda Octavia	163.031
1	Kit reparación elevalunas Audi A2	163.111
1	Kit reparación elevalunas Audi A3, A6	163.112
1	Kit reparación elevalunas Audi A4 '02->	163.113
1	Kit reparación elevalunas izquierdo Seat Córdoba Vario, Ibiza '02->, VW Polo Classic, Variant	163.243
1	Kit reparación elevalunas derecho Seat Córdoba Vario, Ibiza '02->, VW Polo Classic, Variant	163.311



163.598 - Dcho.  
163.599 - Izdo.



163.546\* - Dcho.  
163.547\* - Izdo.



163.564\* - Dcho.  
163.565\* - Izdo.



163.600 - Dcho.  
163.601 - Izdo.



162.818

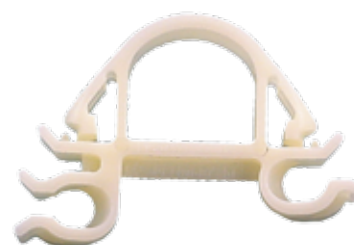

162.841



163.664\*



163.176



163.067

(imagen 1/2 tamaño real)

U.E.	DESCRIPCION	Ref. Adaptable	
10	Fijac. tubo aire cierre centralizado VAG	162.818	
10	Fijac. elevallunas y varilla apertura puerta VW Golf III, Polo '95	162.841	1H0 837 498
25	Fijac. varilla puerta Audi 100, A3 ->'03, A4 ->'01, A6 ->'97, Seat Arosa, Ibiza/Cordoba '97->'99, Leon '99->'05, Toledo '99->'05, VW Caddy '04, Golf ->'05, Lupo, Passat ->'97, Polo ->'02, Transporter '91->'03	163.067	171 837 199
25	Fij. cristal lateral puerta trasera Seat Altea, Ibiza/Cordoba '02->'09, Leon '99->'05, Toledo '99->'09, Skoda Fabia '00->'09, Octavia '04->'08, Roomster, Superb, VW Bora, Golf IV y V, Passat '97->', Polo '95->'02 y '02->'09, Tiguan, Touran (ver PSA)	163.176	6N0 839 511
1	Soporte cristal elevallunas trasero derecho Seat Leon '05, Toledo '04->	163.546	
1	Soporte cristal elevallunas trasero izquierdo Seat Leon '05, Toledo '04->	163.547	
1	Soporte cristal elevallunas derecho Seat Alhambra, VW Sharan (ver Ford)	163.564	
1	Soporte cristal elevallunas izquierdo Seat Alhambra, VW Sharan (ver Ford)	163.565	
1	Soporte cristal elevallunas derecho VW Transporter T5	163.598	
1	Soporte cristal elevallunas izquierdo VW Transporter T5	163.599	
1	Soporte cristal elevallunas delantero derecho VW Touran	163.600	
1	Soporte cristal elevallunas delantero izquierdo VW Touran	163.601	
1	Kit reparación elevallunas VW Touareg	163.664	

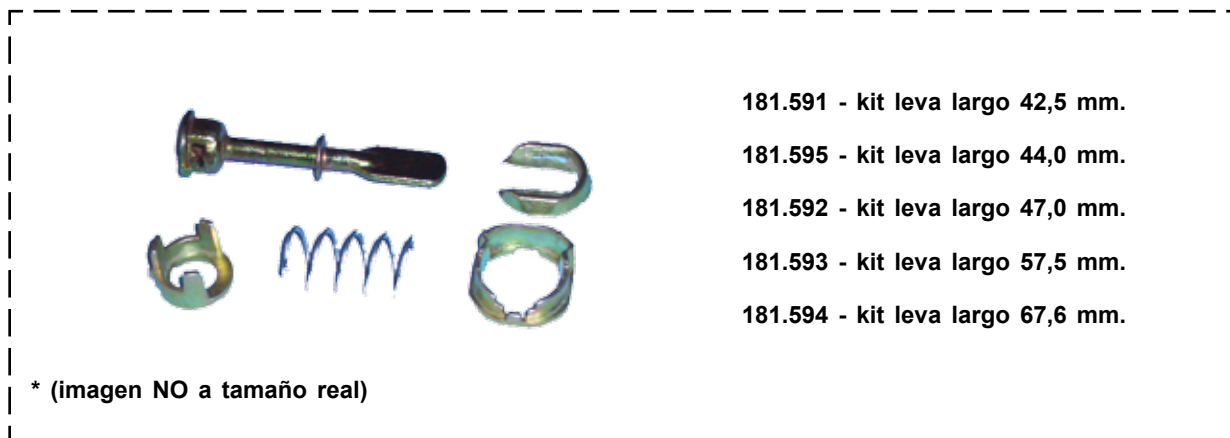
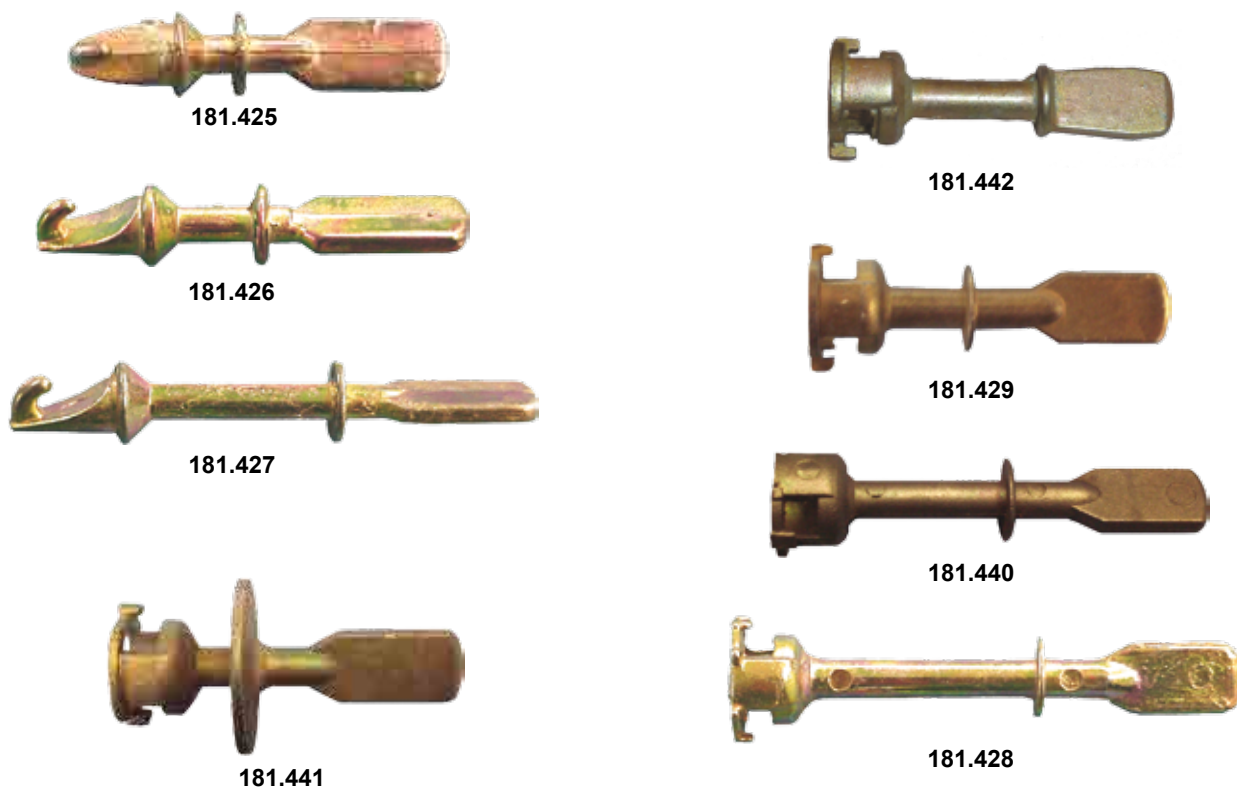

U.E.	DESCRIPCION		Ref. Adaptable
10	Leva cerradura puerta (largo: 50,1 mm.) Seat Ibiza/Cordoba '93->'99	181.425	6K3 837 223
10	Leva cerradura puerta (largo: 56,7 mm.) VW Golf/Vento III '92->'99, Polo Derby '95->'00	181.426	1H0 837 223 B
10	Leva cerradura puerta (largo: 71,3 mm.) Seat Ibiza/Cordoba '93->'99, Inca '96->'03	181.427	6K4 837 223
10	Leva cerradura puerta codificada (largo: 67,6 mm.) Seat Ibiza / Cordoba '97->'02 (5 puertas), Inca '96->'03, VW Caddy '96->'03, Polo Classic '97->'02	181.428	6K4 837 223 A
10	Leva cerradura puerta codificada (largo 47 mm.) Seat Ibiza/Cordoba '97->'02 (3 puertas)	181.429	6K3 837 223 A
10	Leva cerradura puerta codificada (largo 57,5 mm.) VW Polo Derby '95->'02	181.440	6N0 837 223 A
10	Leva cerradura puerta codificada (largo 42,5 mm.) Seat Alhambra, VW Sharan '96->'09	181.441	7M0 837 223 A
10	Leva cerradura puerta codificada (largo 44 mm.) VW Golf IV, Bora '99, Fox	181.442	
1	Kit cerradura puerta codificada (largo 42,5 mm) - varios modelos -	181.591	
1	Kit cerradura puerta codificada (largo 47,0 mm) - varios modelos -	181.592	
1	Kit cerradura puerta codificada (largo 57,5 mm) - varios modelos -	181.593	
1	Kit cerradura puerta codificada (largo 67,6 mm) - varios modelos -	181.594	
1	Kit cerradura puerta codificada (largo 44,0 mm) VW Golf IV, Bora '99, Fox	181.595	1U0 837 167 E 1U0 837 167 C



# V.A.G. (AUDI / SEAT / SKODA / VW)



162.230



162.847



163.105



163.072



163.152



163.154



163.877



162.503



162.235



163.106



163.082



163.740



163.755



163.134



163.213



163.954



162.659



162.421



163.115



163.545

U.E.	DESCRIPCION	Ref.	Adaptable
25	Fijac. revestimientos interiores Seat Alhambra, VW Sharan '96->'00 (ver Ford)	162.230	7M0 883 069
50	Fijac. panel puerta - varios modelos - (ver BMW, Ford)	162.235	823 867 299
50	Fijac. panel puerta y revestimientos interiores VW Golf, Polo	162.421	801 867 299
50	Fijac. panel puerta VW Golf, Polo	162.503	171 807 249 A
50	Fijac. revestimientos interiores - varios modelos -	162.659	811 863 905 A
50	Fijac. tapizados puerta, portón trasero y otros usos interiores Audi A3 '97->'03, A6 '98->'09, A8, TT, Seat Alhambra '96->'09, Seat Ibiza '97->'99, Córdoba '97->'02, VW Polo Classic '97->'02, Sharan '96->'09, Transporter '97->'03 y '03-> (Eurocode 3550SSCVFDX) (ver Ford)	162.847	7M0 867 299 K
25	Fijac. tapizados interiores Seat Arosa, VW Lupo, Polo '95	163.072	6X0 868 243 A
50	Fijac. tapizados posteriores Audi A4 '01->'08 (ver Dacia, PSA, Renault, Volvo)	163.082	8E9 867 299
50	Fij. tapizados interiores Audi A6, 80/100/200, Seat Ahambra '96->'09, VW Sharan '96->'09, Transporter '91->'09	163.105	703 867 299
50	Fijac. tapizados interiores Audi A6, A8, 80, 100	163.106	893 867 290
25	Fijac. tapizados interiores VW Transporter (ver Renault)	163.115	251 867 299
25	Fijac. tapizados interiores pilar A, VW Polo '02->'09	163.134	6Q0 880 385
50	Fijac. panel puerta Seat Arosa, VW Lupo	163.152	6X0 867 300 A
50	Fijac. panel puerta Audi A4 '01->'08	163.154	8E0 867 276
25	Fijac. moldura guía puerta corredera VW Caddy '04, Transporter 2003->	163.213	7H0 843 658 A
25	Fijac. tapizados interiores pilar B y C Seat Altea, Ibiza/Cordoba '02->'08, Leon '05, Toledo '05 fij. moldura rejilla parabrisas "torpedo" Seat Altea, Leon '05, Toledo '05-> (Eurocode 7610LSCHRQ)	163.545	6L6 853 575 A 6L6 853 575
50	Fijac. panel puerta Skoda Fabia '07->, Octavia '04->, Roomster	163.740	5J0 867 276
25	Fijac. cubierta carril guía puerta corredera VW Transporter '09->	163.755	7H0 843 514
25	Fijac. panel puerta VW Golf V, Golf Plus, Jetta '06	163.877	1K6 837 200 A
25	Fijac. panel puerta Audi A6 '05->	163.954	4F0 831 719



163.468



163.469



162.946



163.089



163.387



163.117



163.212



163.470



163.541



163.104



163.073



163.108



163.648



163.687



163.396



163.834



163.835



163.875

U.E.	DESCRIPCION	Ref. Adaptable
25	Fijac. tapizados panel puerta Seat Ibiza/Cordoba '02->'08, León '99->'05, Toledo '99->'05, VW Golf IV '98->'04, Passat '97->'05 (Eurocode 8556LSCSFD)	162.946 3B0 868 243
25	Fijac. tapizados interiores - modelos modernos -	163.073 4D0 867 299 D 701 867 549 443 867 299
25	Fijac. tapizados interiores Seat Ibiza/Córdoba '99->'02, VW Touareg	163.089 6K0 868 243 C
50	Fijac. tapizados interiores VW Golf '98->'04, Bora, Lupo, Passat '97->'05	163.104 3B0 837 732
10	Fijac. tapizados bajo cristal trasero y alfombras Seat Alhambra, VW Passat, Sharan	163.108 3B9 863 689
50	Fijac. tapizados interiores Audi A2, A4 '03->'09, Seat León '99->'05, Toledo '99->'05, Ibiza/Cordoba '02->'08, VW Passat '97->'05, Golf IV	163.117 8Z0 868 243 3B0 868 243
25	Fijac. tapizados puertas Audi A3 '03-> (2 puertas), TT '07->, R8	163.212 8P0 868 243
25	Fijac. tapizados puertas Audi A3 '03-> (4 puertas)	163.387 8P0 868 243 A
25	Fijac. tapizados interiores Audi A4 '01->, A6 '05->, R8	163.396 8E0 837 485 C
25	Fijac. tapizados puerta Audi A3 '04->, A4 '01->'08, Seat Exeo (Eurocode 8572LSCSFD1B)	163.468 8E0 868 243
25	Fijac. tapizados interiores VW Fox, Gol, Parati, Saveiro	163.469 5X0 867 299
25	Fijac. panel puerta Audi A1, A4 '08->, A5, Q5, Q7, VW Golf VI '09->, Passat '11->, Polo '10->, Scirocco '09->, Touareg '03, Transporter '03 y otros usos interiores Caddy '04-> (Eurocode 8579SSCVFD) (ver Volvo)	163.470 7L6 868 243
25	Fijac. panel puerta VW Caddy '04, EOS, Golf V '04->'09, Passat '05->, Phaeton, Polo '02 y '10->, Tiguan, Touran (Eurocode 8568LSCHFD)	163.541 6Q0 868 243 6Q0 868 241
25	Fijac. tapizados interiores Seat Ibiza '09, VW Golf V y VI, Golf Plus, Passat '05->, Scirocco '09, Tiguan, Touran	163.648 3C0 867 333
25	Fijac. junta goma puerta Skoda Superb '02->'08, VW Bora, Golf IV, Passat '97->'05	163.687 3B0 839 723
50	Fijac. junta goma puerta Seat Ibiza '02->, León '99->'05, Toledo '99->'05	163.834 1M0 837 720 E
50	Fijac. junta goma puerta Seat Cordoba '03->, Ibiza '02->, León '99->'05, Toledo '99->'05	163.835 1M0 837 720 F
50	Fijac. junta goma puerta Skoda Octavia '04, Roomster, VW Golf VI, Scirocco '08,	163.875 1Z0 837 732 A



162.300



162.784



163.244



163.245



162.769



162.670



162.671



162.877



163.151

U.E.	DESCRIPCION		Ref. Adaptable
25	Fijac. panel puerta y revestimientos interiores VW Golf III (tipo largo)	<b>162.300</b>	1H0 868 243
25	Fijac. panel y revestimientos interiores VW Golf III / IV (monta con 162.671)	<b>162.670</b>	1H0 868 246 A
25	Fijac. panel y revestimientos interiores VW Golf III / IV (monta con 162.670)	<b>162.671</b>	1H0 868 244 B
25	Fijac. panel puerta VW Golf III (monta con 162.770)	<b>162.769</b>	1H0 868 246 B
25	Fijac. panel puerta y revestimientos interiores VW Golf III, Golf IV (tipo corto)	<b>162.784</b>	1H0 868 243 B
5	Fijac. tapizados interiores puertas traseras Audi A4 '95->'01, A6 '98->'05	<b>162.877</b>	8D0 839 825 A
25	Fijac. tapizados puerta Seat Arosa, VW Lupo	<b>163.151</b>	6X0867301B01C
25	Fijac. panel puerta y revestimientos interiores Seat Ibiza '93->'99, Cordoba '93->'02, Inca '96->'03, VW Caddy '96->'03, Polo Classic/Variant '96->'02	<b>163.244</b>	6K0 868 243
25	Fijac. panel puerta y revestimientos interiores Seat Ibiza/Cordoba, '93->'99, Inca '96->'03, VW Caddy ->'03, Polo '96->'02	<b>163.245</b>	6K0 868 243 A



162.674



162.297



163.209



163.542



162.767



163.230



Ø 5,5

163.760



Ø 6

162.704



Ø 6,5

163.129



Ø 8

162.780



Ø 8

162.782



Ø 10

162.781

U.E.	DESCRIPCION		Ref. Adaptable
10	Fijac. revestimientos interiores VW Golf ->'92, Jetta, Passat ->'97	162.297	3A0 867 301 191 867 301 A
10	Fijac. revestimientos interiores Seat Toledo '92->'99, VW Golf ->'92, Passat ->'99, Transporter '91->'04	162.674	321 867 299 B
25	Fijac. tapizados interiores y parachoques Audi 80, 90, 100, A4, A6	162.704	811863905D01C
10	Fijac. revestimiento portón Skoda Octavia '97->, VW Golf III, Polo '95->'02	162.767	1H0 867 981
50	Fijac. revestimientos interiores VW Golf III	162.780	191 867 199 C
50	Fijac. revestimientos interiores VW Golf III, Transporter '99->'04	162.781	1H0 867 199
50	Fijac. revestimientos interiores Audi A3 '04->, A4 '95->, A5, A6 '95->, Q5, TT, Seat Inca '96->'04, Skoda Fabia, Roomster, Superb, VW Caddy '96->'03, Golf III, LT, Polo '95->'02, Transporter (ver BMW, Ford, Opel)	162.782	N 90201601
50	Fijac. tapizados interiores (parte inferior trasera) Audi A4 '01->'05, A8, Seat Altea, Ibiza/Cordoba '93->'02, Inca, Leon '99->'05 y '05->, Toledo I, II y III, VW Caddy '96->'03, Golf II, Passat ->'97 (ver Ford)	163.129	357 863 119
25	Fijac. revestimientos montante pilar A, Passat '88->'97	163.209	357 867 300 A
25	Fijac. tapizados Seat Alhambra '96->'09, Altea, Leon '05->, Toledo '05->, VW Sharan '96->'09, Touareg, Transporter '03-> (ver Ford)	163.230	7M0 868 563
25	Fijac. tapizados interiores VW Passat '97->'05	163.542	N 908 131 01
25	Fijac. tapizados portón trasero Audi Q5, Seat Alhambra '09, VW Polo '09, Sharan '09, Touran '09, LT '09, Transporter '09	163.760	6X0 827 951 B

# V.A.G. (AUDI / SEAT / SKODA / VW)



162.779



162.884



163.177



163.207



162.777



162.772



162.773



163.116



163.204



163.205



163.974

U.E.	DESCRIPCION		Ref. Adaptable
25	Fijac. revestimientos interiores laterales VW Golf III (sin espuma antivibrante)	162.772	1H0 867 276 A
25	Fijac. revestimientos interiores laterales VW Golf III (sin espuma antivibrante)	162.773	1H0 867 276 C
10	Fijac. metaloplástica revestimientos interiores Seat Arosa, VW Lupo, Polo '95->'02	162.777	6N3 868 561
50	Fij. tapizados portón y otros usos interiores Seat Alhambra '96->'09, Arosa, Ibiza/Cordoba '93->'09, Inca, León '99->'05, Toledo '99->'05, Skoda Octavia '97->'09, Superb, VW Caddy '96->'03, EOS, Golf III, IV y VI, Jetta, Passat ->'05, Phaeton, Polo '95->'09, Scirocco '09, Sharan '96->'09, Touran, Transporter '03->	162.779	357 867 646
50	Fijac. tapizados techo Seat Toledo '92->'99, VW Golf II, Passat ->'93, Transporter '96->'04	162.884	321 867 838
50	Fijac. revestimientos interiores de montantes laterales Seat Ibiza/Cordoba '02->'09, Inca '99->'01, León '99->'05, Toledo '99->'05, Skoda Octavia '97->'09, Superb, VW Bora, Golf IV, New Beetle, Passat '97->'05, Polo '95->'02	163.116	6N0 867 276
25	Fijac. revestimientos interiores Seat Alhambra '03->'09, Ibiza/Cordoba '02->'09, Leon '05->, VW Sharan '03->'09, y fijac. revestimientos techo Córdoba '99->'02, Polo Classic '00->'02	163.177	6K0 867 838 A
25	Fijac. revestimientos laterales Seat Ibiza/Córdoba '02->'09, León '02->'05, Toledo '02->'05	163.204	1M0 867 276
25	Fijac. alfombras piso y revestimientos interiores VW New Beetle '06->, Golf IV	163.205	1J0 867 276 B
25	Fijac. tejadillo VW Golf IV '98->'02	163.207	1J0 867 646
25	Fijac. revestimientos interiores laterales traseros Seat Ibiza '09->	163.974	6J0 867 276



U.E.	DESCRIPCION	Ref. Adaptable
25	Fijac. panel puerta Audi A8 (ver Ford)	162.257 4D0 868 637
50	Fijac. anagramas de tipo de modelo, fijac. tapizados puerta Seat Ibiza/Cordoba, León, Toledo, Skoda Octavia, VW Golf, LT, Passat, Polo, Transporter	162.267 191 853 615 A
10	Fijac. indicadores y luz de freno VW TT (ver Fiat)	162.720 8N0 951 257
50	Fij. moldura estribera VW New Beetle, fijac. rejilla delant. a parachoques Polo ->'00, Passat ->'97	162.837 3A0 853 586
50	Fijac. pasoruedas, revestimientos y otros usos V.A.G. (ver BMW)	162.921
50	Fijac. pasoruedas, tapizados y otros usos Seat Ibiza/Cordoba '93->'99, VW Golf IV, New Beetle, Polo '95->'02.	162.922 N 90474001
50	Fijac. pasoruedas, revestimientos y otros usos V.A.G. (todos los modelos)	162.923 171 201 969
50	Fijac. pasoruedas, parachoques y otros usos Seat Ibiza/Cordoba '93->'02, Inca, León '99->'05, Toledo '99->'05, VW Caddy '96->'03, Polo Classic '96->'02 (ver Mercedes)	162.924 441 955 973 B
50	Fijac. revestimientos (tornillo Ø 6) V.A.G. (ver B.M.W., Ford, Mini, Opel)	162.948 N 90127883
25	Fijac. anagramas Audi A4	163.075 8D0 853 622
25	Fijac. tapa interior retrovisor Seat Altea, Arosa, Toledo '05->, VW Golf IV, Lupo, Polo, Touran	163.076 865 853 231 A
25	Fijac. panel puerta y revestimientos interiores Audi 100, 200, A2, A3 '97->'03 y '03->, A4 '95->'08, A6 '95->'09, A8	163.188 8L4 831 720
25	Fijac. faro antiniebla A2, A3 '01->'08, A4 '99->'08, A6 '98->'05, A8, fijac. parachoques A6 '98->'05 (ver Renault)	163.428 8D0 807 192
25	Fijac. pasoruedas Audi A1, A4 '08, A6 '05, A7, Q5	163.893 4F0 825 429 A

# V.A.G. (AUDI / SEAT / SKODA / VW)

6 x 6  
Tornillo Ø 3



162.326

Ø 6  
Tornillo Ø 4,2



162.783

6 x 6,5  
Tornillo Ø 2,5



162.842

7 x 7  
Tornillo Ø 3,5



162.817

7 x 7  
Tornillo Ø 3,5



163.181

7 x 7  
Tornillo Ø 3,5



162.776

7 x 7  
Tornillo Ø 4



162.331

7 x 7  
Tornillo Ø 4



162.775

7 x 7  
Tornillo Ø 4,2



162.562

7 x 7  
Tornillo Ø 4,2



162.244

7 x 7  
Tornillo Ø 4,8



162.835

7 x 14  
Tornillo Ø 4,2



163.350

7 x 15  
Tornillo Ø 4,2



162.888

7 x 7,5  
Tornillo Ø 3,5



162.774

7,5 x 7,5  
Tornillo Ø 4,2



162.885

7,5 x 7,5  
Tornillo Ø 4,2 - 4,8



162.836

7,5 x 7,5  
Tornillo Ø 4,8



163.388

U.E.	DESCRIPCION	Ref.	Adaptable
100	Fijac. parachoques y otros usos Seat Ibiza/Cordoba '97->'02, Inca, Toledo '92->'99, VW Caddy '96, Golf Cabriolet, Polo Classic (ver Fiat, PSA)	162.244	155 809 966
100	Fijac. - varios usos - VW Golf '90 (ver Fiat, Seat)	162.326	
50	Fijac. pasoruada y otros usos Audi 100, 200, A2, A3, A4, A5, A6, A6, Q5, Q7, TT, Seat Alhambra, Altea, Arosa, Ibiza/Cordoba, Inca, León/Toledo, Skoda Fabia, Octavia, Roomster, Superb, VW Bora, Caddy, Golf (todos), EOS, Fox, LT, Lupo, Passat, Phaeton, Polo, Scirocco, Sharan, Tiguan, Touran, Touareg, Transporter	162.331	811 807 577 C 867 809 966
25	Fijac. - varios usos - Seat Ibiza, fijac. manecilla apertura puerta Audi 100, 200, A3 '97->'03, A4 '95->'01, A6 '95->'97, A8	162.562	443 853 547 B
50	Fijac. pasoruada y tapizados interiores Audi 100, 200, A2, A3, A4, A5, A6, A6, Q5, Q7, TT, Seat Alhambra, Altea, Arosa, Ibiza/Cordoba, Inca, León, Toledo, Skoda Fabia, Octavia, Roomster, Superb, VW Bora, Caddy, Golf (todos), EOS, Fox, LT, Lupo, Passat, Phaeton, Polo, Scirocco, Sharan, Tiguan, Touran, Touareg, Transporter	162.774	811 807 577 C
25	Fijac. pasoruada VW Fox '05, Gol, Polo Classic '04	162.775	6N0 809 966 A
25	Fijac. parachoques, rejilla radiador y revestimientos interiores Audi A4 '01, A8, Seat Alhambra, Altea, Arosa, Ibiza/Cordoba, León/Toledo, VW Bora, Caddy, Golf III, IV y V, Jetta, Lupo, New Beetle, Passat, Polo Classic, Sharan, Transporter	162.776	165 827 592
25	Fijac. rejilla toma aire a parachoques VW Polo '95	162.783	N 905 353 01
25	Fijac. faro Audi / VW (ver Nissan)	162.817	
25	Fijac spoiler lateral (bajo puerta) VW Golf III	162.835	1H0 853 947
25	Fijac. pasoruada Audi A2, A4, Seat Ibiza/Cordoba '02, VW Lupo, Passat, Polo '02, Touareg, fijac. parachoques A3, A4, Q5, Q7, Seat Ibiza/Cordoba '99, León, Toledo, VW Golf IV, New Beetle, fijac. talonera Seat Altea, Toledo '05, fijac. tapizados VW Crafter '06	162.836	N 90821401
100	Fijac. retrovisor exterior a puerta VW Golf III y IV, Polo '95, fijac. panel puerta Skoda Fabia,	162.842	1H0 853 120
25	Fijac. pasoruada A3, A4, Q7, Altea, Arosa, Ibiza/Cordoba, León, Toledo, Caddy '04, Golf III, IV y V, EOS, Lupo, New Beetle, Passat '00, Phaeton, Polo, Scirocco '09, Tiguan, Touran, Transporter	162.885	N 908 338 01
50	Fijac. tapizados Seat Cordoba/Ibiza '99->'02, Toledo '92->'99, VW Polo ->'02 (ver Fiat)	162.888	1L0 867 616
50	Fijac. carcasa pasoruada interior Audi 100, A4, A6, VW Bora, Golf IV	163.181	811 807 577 B
50	Fijac. tapizados puerta VAG - varios modelos - (ver BMW)	163.350	N 910 444 01
50	Fijac. parachoques Audi A4 '01, Superb, VW Polo '00->, fijac. pasoruada VW Caddy '04, Phaeton	163.388	N 105 073 01

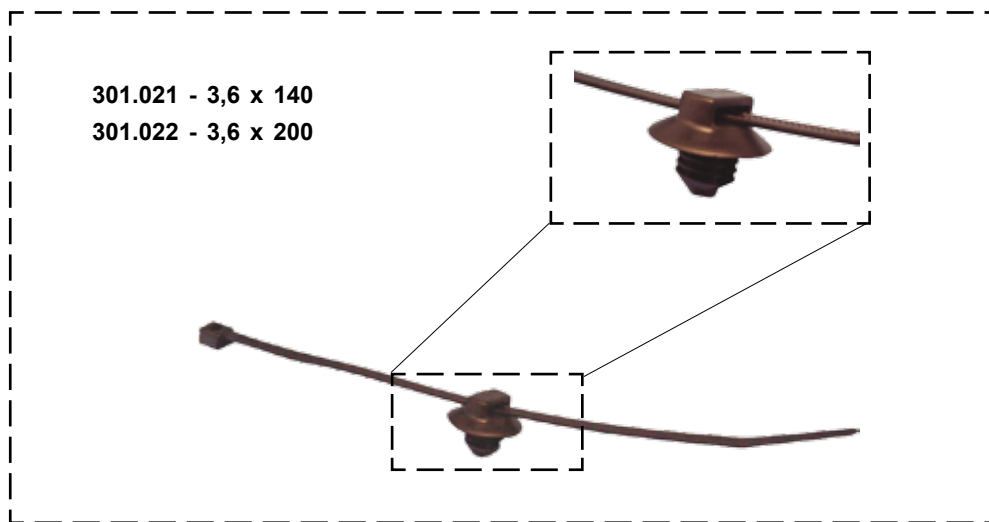

U.E.	DESCRIPCION		Ref. Adaptable
10	Fijac. spoiler Seat Ibiza/Cordoba, Inca, VW Golf '84, Polo '95	<b>162.429</b>	N 90206501
25	Fijac.matrícula - varios modelos -	<b>162.716</b>	321 813 988 A
25	Fijac. matrícula VW Golf II, Passat, Vento	<b>162.833</b>	357 827 998
25	Fijac. revestimientos interiores y fijac. placa matrícula VW Golf, Passat, Polo, Transporter, Vento, fijac. rejilla aire VW New Beetle	<b>162.930</b>	357 868 143
25	Fijac. matrícula Seat Ibiza/Cordoba '93, Toledo '92, VW Golf III y IV, Polo Classic '96, Passat '92	<b>163.038</b>	357 827 998 A
25	Fijac. revestimientos interiores Audi 80, 100, A2, A4, A6, Seat Ibiza '02, VW Passat, fijac. talonera puerta VW Passat '97->'05, fijac. pasoruada Seat Altea, Toledo '05	<b>163.051</b>	4A0 857 610
25	Fijac. tapizados interiores Seat León '99->'05, Toledo '99->'05, VW Bora, Golf IV	<b>163.107</b>	1J0 853 120
50	Fijac. recubrimiento puerta delantera Bora, Golf IV y V, Scirocco '09, fijac. panel puerta A4, Arosa, Caddy '04, Lupo, Passat '97->, fijac. tapizados interiores Phaeton, fijac. tapizados portón A5, fijac. moldura pasoruada Golf Plus, parachoques trasero A6, Altea, Ibiza/Cordoba '02, Polo '02->, fijac. panel puerta, moldura pasoruada y techo Q7, Touareg, Touran, Transporter	<b>163.178</b>	N 105 168 01
50	Fijac. parachoques VW Passat '88->'93, fijac. soporte placa matricula VW Golf III - y varios usos -	<b>163.211</b>	175 867 949
25	Fijac. revestimientos interiores Audi A3, A4, A5, A6, Q7, TT, VW Caddy '04, Golf V y VI, Passat '05, Scirocco '09, Tiguan	<b>163.393</b>	N 10621301
25	Fijac. soporte matrícula Audi A6 '10->, A7 '10->	<b>163.975</b>	4G0 827 310
50	Abrazadera 3,6 x 140 con soporte -varios modelos-	<b>301.021</b>	
50	Abrazadera 3,6 x 200 con soporte -varios modelos-	<b>301.022</b>	6K0 971 898 D



# V.A.G. (AUDI / SEAT / SKODA / VW)

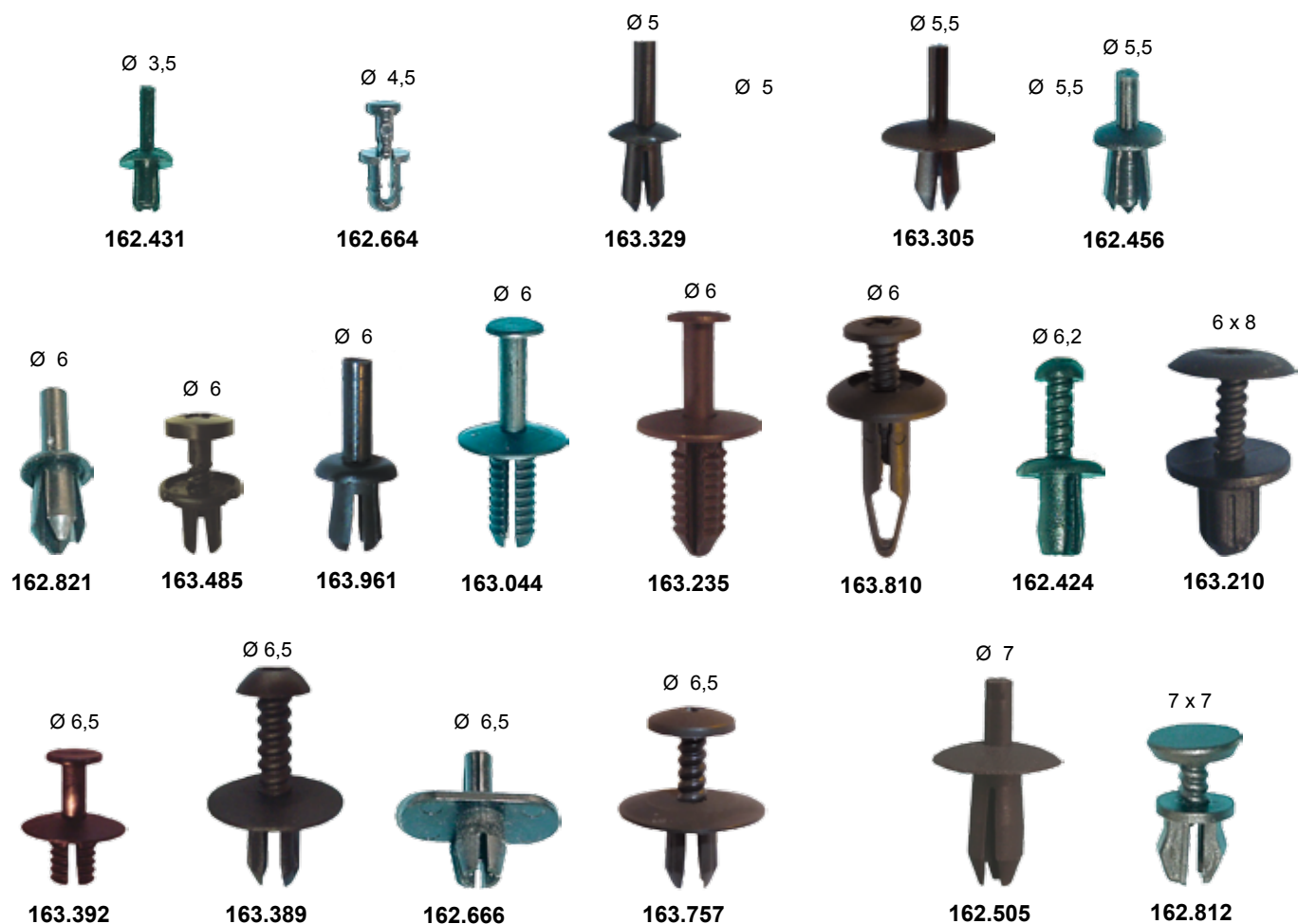

U.E.	DESCRIPCION	Ref. Adaptable
50	Remache fijac. tapa filtro rejilla Seat León / Toledo '99->'05 (ver Fiat, Mercedes, PSA, Renault)	162.424 1M0 853 547 A
100	Remache fijac. varios usos V.A.G. (ver BMW, Opel, PSA)	162.431 113 857 117 B
50	Remache revestim. interiores -varios modelos- (ver BMW, Mercedes, PSA, Renault)	162.456 N10259301
50	Remache fijac. revestimientos interiores VW Golf y LT (ver Mercedes)	162.505 171 885 767
25	Remache fijac. guarnición capó VW, Audi	162.664 893 823 740
25	Remache fijac. guarnición puerta Audi 80, 90 y coupé, A4 '95	162.666 811 807 447
50	Remache fijac. tapizados interiores Audi A6 '05, Seat Altea, León '05, Toledo '05, VW Caddy '04, Golf V y VI, EOS, Jetta, New Beetle, Passat '05, Scirocco '09, Tiguan, Touran (ver Ford)	162.812 1C0 867 207
100	Remache fijac. varios usos Audi A1, A3, A4 '08, A5, A8, Q7, Seat León '99->'05, Toledo '99->'05, Skoda Fabia, Octavia, Roomster, VW Bora, Golf IV, LT, New Beetle, Passat, Touran, Touareg, Transporter '03->	162.821 N0385011 N0385012
50	Remache fijac. pasoruada y bajos carrocería Audi A3 '04->, Seat Altea, León '05->, Toledo '05->, Skoda Octavia '04, Superb '08, fijac. parachoques y pasoruada VW Caddy '04, Golf V y VI, EOS, Jetta, Passat '05, Phaeton, Scirocco '09, Tiguan, Touran (ver BMW, Mini)	163.044 N 909 591 01
50	Remache fijac. revestim. interiores Seat Arosa, León '99, Toledo '99, Skoda Octavia '97, VW Golf, Lupo, New Beetle, Polo '00	163.210 1H0 819 145 B41
25	Remache fijac. varios usos V.A.G. (ver Mercedes, Opel)	163.235
50	Remache fijac. parachoque VW LT '04->'07 (ver Mercedes, Opel, Volvo)	163.305 N 102 195 01 N 102 195 02
50	Remache fijac. tapizados interiores Seat León '99->'05, Toledo '92->'99 y '99->'05 (ver Nisan)	163.329 1L0 853 934
25	Remache fijac. varios usos Audi A4, A6 (ver Volvo)	163.389
25	Remache fijac. varios usos Seat Altea, Ibiza '06->, León II, Toledo III	163.392
50	Remache fijac. tapizados interiores Audi A4, A6, Q5, Q7 (ver PSA)	163.485 7L6 868 307 8Z0 857 784
25	Remache fijac. cubierta parachoques Audi A4 '08->, A5, Q5 '09->	163.757 8T0 807 300 A
25	Remache fijac. parachoque trasero Audi A5, Q5 '09->, Seat Ibiza '09->, fij. aleta delantera Touareg	163.810 6L0 121 136
50	Remache fijac. talonera puerta Audi A1, fijac. pasoruada Skoda Octavia '04, fijac. parachoques Skoda Roomster '06, fijac. tapizados interiores Audi A2, Seat Arosa y otros usos -varios modelos-	163.961 N10417901



U.E.	DESCRIPCION	Ref. Adaptable
100	Remache fijac. revestimientos interiores VW Polo (ver PSA)	<b>162.341</b>
100	Remache fijac. pasoruada A3, A4, A6, Golf III y IV, Polo, Vento, fijac. parachoques VW Golf III y IV, Bora, New Beetle, Passat, Transporter, fijac. revestim. Passat (ver Ford, Mercedes, Opel, PSA)	<b>162.373</b> 161 867 299 N 038 549 01
50	Fij.pasoruada y revestim. Audi TT, Seat Ibiza/Cordoba '99->'02, VW Bora, Golf, Passat, New Beetle, fij. parachoques Alhambra, Caddy '04, LT, Passat ->'97, Phaeton, Sharan, Touareg, Transporter, fijac. parrilla radiador Leon '99, Toledo '99, Polo, fij. armazón delantero Golf 3 (ver Ford)	<b>162.632</b> N 0385501
25	Remache fijac. rejilla radiador y spoiler VW Caddy ->'92, Golf I y II, Transporter T2 ->'92	<b>162.665</b> 171 853 695 A
50	Remache fijac. rejilla parabrisas "torpedo" VW Golf III, Skoda Octavia '97->	<b>162.765</b> 1H0 819 055 C
50	Remache fijac. revestimientos interiores VW Golf III, Passat '92->'05	<b>162.766</b> 1H0 867 199 A
25	Remache fijac. revestimiento interior maletero Seat Cordoba '97->'09, Ibiza '97->'99, Bora, Golf III, New Beetle Cabrio, Passat ->'05, Polo '95, fijac. rejilla radiador Seat Leon '99->'05, Toledo '99->'05, fijac. gancho capó Audi A4 '95->'01	<b>162.843</b> 333 867 633 4FB
50	Remache fijac. varios usos VW Golf, Jetta'97 (ver Mercedes, PSA)	<b>163.014</b>
25	Remache fijac. insonoriz. A2 '00->'05, fijac. cubierta parachoques Q7, fijac. tapizados interiores A8	<b>163.074</b> 4D0 807 300 B
50	Fij. bajos carroceria A4 '01->, A5, A6 '05->, Q5, TT, Golf 5, Passat, Touran, fij. pasoruada A3 '04->, fij. conducto aire parach. Ibiza / Cordoba '02->, Leon '05, fij. suspensión Audi A3 '04->, Seat Altea, Leon/Toledo '05, Octavia '04, Superb, Golf V y VI, Passat '05, Tiguan, Touran (ver Ford, Renault)	<b>163.091</b> 8E0 825 267
10	Remache fijac. parachoques delantero Audi A3 '97->'03	<b>163.109</b> 8L0 807 300
50	Fijac. parachoques y bajo capó Audi 80, 100, 200, A6, bajos carroceria A8 '03-> (ver Ford, Renault)	<b>163.306</b> N 902 293 01
50	Remache NEGRO fij. tapizados interiores Bora, Caddy '04, Golf III y IV, LT, EOS, Jetta, Passat '05, Phaeton, Polo '95, Tiguan, Touran, Transporter, Vento fijac. parachoques y radiador LT, Transporter	<b>163.390</b> 701 867 299 01C
50	Remache GRIS fijac. tapizados interiores Bora, Caddy '04, Golf III y IV, LT, EOS, Jetta, Passat '05, Phaeton, Polo '95, Tiguan, Touran, Transporter, Vento fijac. parachoques y radiador LT, Transporter	<b>163.391</b> 701 867 299 U71
25	Remache fijac. pasoruada Audi A2 '00->'05, A8, TT '07->, fijac. cubierta parachoque delantero Q5	<b>163.743</b> ● 4D0 807 300
25	Remache fijac. aletas Audi A1, A4 '08-> y fijac. puerta Audi A4 '08->	<b>163.756</b> ● 8K0 868 307
50	Remache fijac. pasoruada, moldura estribera y rejilla parabrisas "torpedo" Seat Ibiza '09->	<b>163.794</b> ● 5P0 810 997
50	Remache fijac. aleta delantera Seat Ibiza '09-> (ver Volvo)	<b>163.903</b> ● 6J0 821 213



190.359\*



190.379\*



190.380\*

\* (imagen 1/2 tamaño real)



163.335



163.336



163.337



163.199



163.334



163.736



163.360

U.E.	DESCRIPCION	Ref.	Adaptable
10	Fijac. moldura lateral parabrisas S60 '01->'09, V70 '00->'08, V70XC ->'07 (Eurocode 8829ASCES1B)	163.199	9190981
10	Fijac. moldura lateral parabrisas S60 '01->'09, V70 '00->'08, V70XC ->'07 (Eurocode 8829ASCSS / 8829ASCES)	163.334	30678009 9484524
10	Fijac. moldura superior parabrisas S40/V40 '96->'04 (Eurocode 8824ASCST)	163.335	30800957
10	Fijac. moldura lateral parabrisas S40/V40 '96->'04 (Eurocode 8824ASCSS / 8824ASC6B)	163.336	30800958
25	Fijac. moldura lateral parabrisas S40/V40 '96->'04 (Eurocode 8824ASC7B / ASCES)	163.337	30873201
10	Fijac. moldura parabrisas 960 / 760 II (Eurocode 8812ASC6B)	163.360	1325285
10	Fijac. moldura lateral parabrisas Volvo 850 '93->'97, S70 / V70 '97->'00 y XC70 '98->'00	163.736	1372682
1	Bomba lavaparabrisas Volvo C30, C70, S40 '05->', V50 '05->' (ver Ford)	190.359	31283805
1	Bomba lavaparabrisas Volvo 960, S70, V70, S90 (ver VAG)	190.379	9178094
1	Bomba lavaparabrisas Volvo C70 ->'05, S40 / V40 ->'04, S60 '01->'09, S80 ->'06, V70 ->'08, XC90	190.380	9169611



U.E.	DESCRIPCION		Ref. Adaptable
10	Fijac. moldura inferior parabrisas S40/V40 '00->'04 (Eurocode 8824ASDS)	163.643	30874958
25	Fijac. rejilla parabrisas "torpedo" V40 '00->'04 (Eurocode 8832ASC6B)	163.644	30864984
10	Fijac. rejilla parabrisas "torpedo" S40/V40 '00->'04	163.646	30870550
25	Fijac. rejilla parabrisas "torpedo" S40/V40 '00->'04 (Eurocode 8824ASC6B)	163.647	30872551
10	Fijac. moldura lateral parabrisas (parte inferior) S80 '97->'06 (Eurocode 8828ASCS)	163.761	9190967
10	Fijac. moldura lateral parabrisas (parte media) S80 '97->'06 (Eurocode 8828ASC7B)	163.762	9190970
10	Fijac. moldura lateral parabrisas (parte superior) S80 '97->'06 (Eurocode 8828ASCSS)	163.763	9190966
10	Fijac. moldura parabrisas (parte trasera) S80 '97->'06 (Eurocode 8828BSCSS)	163.764	6816180
10	Fijac. moldura lateral parabrisas (parte inferior) S60 '11->	163.838	31304111
10	Fijac. moldura lateral parabrisas S60 '11->	163.839	30753989
10	Fijac. moldura parabrisas -techo S60 '01->'09, S80 '97->'06, V70 '00->'08, V70XC (Eurocode 8829ASCES2B)	163.958	8622906



Ø 7

163.890



Ø 8,5

162.959



163.470



163.811



163.082



163.225



Ø 5,5

163.305



Ø 6

163.198



Ø 6,5

163.300



Ø 6,5

163.389



Ø 8

163.277



Ø 8

163.304



Ø 8  
cabeza Ø 20

163.069



Ø 12

163.903

U.E.	DESCRIPCION	Ref. Adaptable
50	Remache fijac. junta puerta delantera XC90 '03-> (ver Ford)	162.959 30661329
25	Remache fijac. cubrecárter y bajos carrocería S40/V40 '00->'04 y otros usos V70, XC70 (ver BMW, Mercedes, Mini)	163.069 30820141
50	Remache fijac. moldura puerta S40 '08->, V50, fijac. talonera puerta C30, S40 '08->, V50, V70 '08->, XC70 '08-> (ver Dacia, PSA, Renault, VAG)	163.082 30648141
25	Fij. rejilla parabrisas "torpedo" S40 '04->, S60 '01->, V50, V70/XC70, XC90 (Eurocode 8828ASCSB) fij. spoiler S40 '04, V50, fij. deflector puerta XC60, parachoques 740, 760 (ver Mercedes, Opel)	163.198 1268176
50	Remache fijac. junta goma puerta C70 '06-> (Ver Renault)	163.225 1285015
10	Remache fijac. parachoques S40 '04->, S60 '01->, S80 '99->'06 y '07->, V50, XC60, XC70, C30, C70 '06, fijac. otros usos XC90, fijac. rejilla parabrisas "torpedo" XC60 '10-> (ver Honda, Nissan)	163.277 3541113
10	Remache fijac. rejilla parabrisas "torpedo" C30, C70, S40 '04->, V50 '04-> (Eurocode 8011ASCH) (ver Subaru, Suzuki)	163.300 987789
25	Remache fijac. moldura talonera puerta S40 '04, S60 '01->'09, V50, V70 '00->'07, C30, fijac. tapizados puerta C70, fijac. parachoques C70, V70 '97->'04	163.304 9133417
50	Remache fijac. parachoques y moldura exterior S40 / V40 '00->'04 (ver Mercedes, Opel, VAG)	163.305 3923475
25	Remache fijac. moldura y panel puerta C70 '06->, fij. otros usos 850, S70/V70 '97->'00 (ver VAG)	163.389 3545549
25	Remache fijac. panel puerta C30, C70, S40 '04->, V50 (Eurocode 8579SSCVFD) (ver VAG)	163.470 8679426
10	Remache fijac. talonera puerta C30, S40 '04->, V50, V70 '08->, XC60 '09->, XC70 '08->	163.811 8678010
50	Remache fijac. parachoques delantero XC60, XC70, fijac. tapizados interiores S40 '04->	163.890 1224786
50	Remache fijac. parachoques S40 / V40 '96->'04, fijac. talonera puerta S80 '07-> (ver VAG)	163.903 30817220

# INDICE - ref. ADAPTABLE

BMW		
Ref. Adaptable	pag.	Triclo
07 11 9 916 949	36	161.474
07 11 9 916 967	36	162.556
07 12 9 901 649	36	161.498
07 12 9 901 656	36	161.788
07 12 9 901 746	38	161.774
07 12 9 904 150	36	161.788
07 12 9 925 708	36	161.493
07 12 9 925 712	36	161.495
07 12 9 925 713	36	161.498
07 12 9 925 720	36	161.704
07 12 9 925 726	36	161.490
07 12 9 925 737	36	161.702
07 12 9 925 770	38	161.774
07 13 0 702 966	44	163.037
07 14 6 965 447	41	163.819
07 14 6 969 296	42	163.350
07 14 6 981 767	36	161.772
07 14 7 054 461	38	161.785
07 14 7 122 912	41	163.457
07 14 7 122 913	41	163.458
07 14 7 136 172	44	163.922
07 14 7 145 753	43	163.753
07 14 7 152 593	43	163.818
07 14 7 154 227	38	161.784
07 14 9 241 763	38	161.786
07 17 7 141 218	43	163.849
12 13 8 530 118	36	162.556
16 13 1 176 747	42	162.948
16 13 1 176 747	42	163.288
23 07 0 22	36	161.427
41 35 8 152 737	36	161.739
51 11 1 908 077	44	163.044
51 11 1 942 789	44	163.466
51 11 1 944 537	44	163.046
51 11 1 964 186	44	163.047
51 11 8 174 185	44	163.045
51 12 3 413 810	36	161.787
51 12 7 164 686	38	161.773
51 13 1 823 634	36	161.473
51 13 1 875 898	41	163.292
51 13 1 885 399	44	163.291
51 13 1 934 160	40	163.842
51 13 1 960 054	41	162.943
51 13 1 960 127	40	163.290
51 13 2 251 394	41	163.289
51 13 2 992 450	38	163.949
51 13 7 064 097	38	163.809
51 13 7 070 747	38	163.816
51 13 7 073 396	38	163.865
51 13 7 073 399	38	163.817

BMW		
Ref. Adaptable	pag.	Triclo
51 13 7 117 240	38	163.801
51 13 7 145 109	39	163.347
51 13 7 145 110	39	163.349
51 13 7 157 702	39	163.775
51 13 7 172 103	39	163.348
51 13 7 177 926	39	163.711
51 13 7 184 575	39	163.777
51 13 7 209 821	39	163.796
51 13 7 217 789	39	163.776
51 13 7 232 420	39	163.952
51 13 7 238 257	39	163.797
51 13 8 102 952	42	163.063
51 13 8 166 675	41	162.944
51 13 8 204 858	38	163.749
51 13 8 231 130	41	163.748
51 14 1 807 495	40	163.460
51 16 1 881 149	44	162.456
51 16 1 943 122	42	163.454
51 18 8 242 693	42	163.848
51 21 8 205 295	44	163.128
51 22 1 817 032	40	163.062
51 25 2 753 575	43	163.823
51 31 1 938 494	39	162.945
51 31 3 401 691	39	163.733
51 31 3 448 374	39	163.733
51 31 7 064 098	39	163.456
51 31 7 177 029	39	163.712
51 31 8 125 892	39	163.058
51 31 8 150 943	40	163.772
51 31 8 177 850	39	162.945
51 32 1 938 884	40	163.055
51 33 7 052 945	38	163.950
51 33 7 140 714	42	163.826
51 35 7 135 518	38	161.775
51 41 1 973 500	43	163.059
51 41 2 155 030	43	163.465
51 41 2 756 212	38	161.783
51 41 7 211 653	43	163.829
51 41 8 101 204	43	163.773
51 41 8 172 050	43	163.751
51 41 8 224 768	43	163.750
51 41 8 224 781	43	163.752
51 43 7 001 491	43	163.843
51 43 8 225 567	43	163.747
51 47 1 840 960	42	163.840
51 47 1 840 961	42	163.841
51 47 1 904 317	42	162.782
51 47 1 911 992	44	163.069
51 47 1 928 808	42	163.770
51 47 7 117 532	42	163.825

BMW		
Ref. Adaptable	pag.	Triclo
51 47 8 234 047	42	163.770
51 47 8 244 458	42	163.928
51 47 8 413 209	42	163.822
51 48 1 884 779	44	163.068
51 48 1 915 964	44	163.827
51 48 1 938 725	44	163.070
51 48 8 181 420	43	163.061
51 49 8 123 832	43	161.420
51 49 8 166 702	44	163.745
51 49 8 237 075	44	163.923
51 51 8 172 050	43	163.059
51 71 1 916 197	43	163.077
51 71 1 927 439	42	163.820
51 71 1 928 946	39	163.056
51 71 1 932 996	40	163.365
51 71 1 945 568	40	163.153
51 71 1 958 025	42	162.921
51 71 1 958 025	42	163.455
51 71 7 002 953	44	163.467
51 71 7 006 757	38	163.951
51 71 7 012 032	38	161.776
51 71 7 066 223	41	163.862
51 71 8 108 613	39	163.078
51 71 8 176 503	36	161.714
51 71 8 184 574	41	163.110
51 71 8 195 811	44	163.125
51 71 8 212 148	36	161.715
51 71 8 212 164	36	161.772
51 71 8 218 323	36	161.716
51 71 8 218 852	36	161.717
51 71 8 259 025	42	163.828
51 76 7 162 587	39	163.863
51 77 7 166 869	41	163.774
51 77 7 170 955	41	163.459
51 77 7 171 004	44	163.467
51 77 7 891 250	41	163.821
61 66 1 380 068	37	190.356
63 11 6 938 563	37	173.041
63 12 0 027 924	37	163.769
63 12 1 387 026	37	163.844
67 12 6 973 097	37	190.382
67 12 8 360 244	37	190.381
67 12 8 362 154	37	190.355
82 11 9 710 191	43	163.746

DACIA		
Ref. Adaptable	pag.	Triclo
6001 546 909	46	163.489
6001 549 265	46	163.491
6001 549 443	45	190.388
7701 056 846	46	163.082
7703 017 090	45	161.750
7703 046 098	45	161.779
7703 046 143	45	161.779
7703 072 360	46	163.088
7703 072 361	46	163.140
7703 077 117	46	163.006
7703 077 435	46	163.008
7703 079 290	46	162.485
7703 081 054	46	162.941
7703 081 056	46	163.320
7703 081 185	46	163.222
7703 081 227	46	163.906
7703 602 059	45	161.731
7703 602 206	45	161.724
7703 602 282	45	161.727

DAEWOO		
Ref. Adaptable	pag.	Triclo
94530507	47	163.307
94530542	47	163.293
94530623	47	163.037
94530624	47	163.163
38410-66113	47	190.365

DAIHATSU		
Ref. Adaptable	pag.	Triclo
90044-67376-000	47	163.264
90044-67395-000	47	163.263
90044-68025-000	47	163.265

# INDICE - ref. ADAPTABLE

FIAT		
Ref. Adaptable	pag.	Triclo
129421	63	162.260
4138439	50	161.448
4241451	58	162.247
4276430	52	164.381
4294167	62	162.679
4343799	67	163.493
4358789	68	162.264
4373915	60	163.492
4378829	60	162.653
4389370	54	190.009
4392447	57	162.273
4399987	64	162.598
4678189	62	162.907
4941207	60	184.866
5041017	62	163.612
5757139	66	162.815
5896153	64	162.896
5940767	50	162.357
5942690	54	190.002
5944525	61	162.871
5946583	58	162.253
5952101	58	162.252
5961759	66	162.706
5962559	63	162.389
5967727	50	162.359
5979901	50	162.393
5981746	56	162.400
5988006	63	162.258
5994095	60	162.316
5998258	62	162.263
7078732	62	162.475
7508973	50	162.359
7538675	65	162.228
7543023	67	162.523
7544349	58	162.248
7556533	63	162.424
7558952	49	161.456
7560860	66	162.706
7561909	52	184.868
7569387	50	162.357
7569468	63	162.519
7569853	57	162.272
7570122	64	162.232
7586380	54	190.004
7587776	69	162.407
7590885	56	162.396
7603637	52	162.406
7603823	65	162.530
7603825	65	162.530
7603825	69	162.531

FIAT		
Ref. Adaptable	pag.	Triclo
7608012	61	162.872
7608099	60	162.901
7608126	56	162.403
7609062	49	161.455
7613917	62	162.691
7617036	62	162.907
7622606	67	162.888
7622907	57	162.270
7622939	50	162.697
7623058	50	162.696
7628035	50	162.356
7630815	48	162.710
7635233	49	162.526
7635984	52	161.408
7636064	69	162.531
7641846	54	190.003
7641970	62	162.391
7644689	58	162.254
7656214	58	162.533
7658843	49	161.706
7658893	65	162.398
7670683	52	162.390
7671135	52	181.413
7677561	51	162.527
7677856	67	162.523
7678439	51	162.525
7678808	62	162.392
7679491	54	190.005
7682336	53	190.364
7686500	62	162.263
7687086	55	190.046
7688208	53	190.351
7689821	67	163.496
7699248	56	162.536
7703577	59	162.535
7729424	51	161.488
7733801	65	162.510
7734462	69	162.889
7734476	53	162.890
7739088	57	162.515
7739729	48	162.529
7739802	69	162.408
7740229	52	182.312
7740882	51	161.464
7745194	69	162.511
7751170	48	161.454
7754387	67	162.892
7762436	56	162.514
7767818	54	190.027
7768047	67	162.909

FIAT		
Ref. Adaptable	pag.	Triclo
7769348	54	190.006
7769767	60	162.900
7769778	64	162.699
7771628	56	162.893
7771629	49	161.458
7775575	60	162.316
7778275	62	162.680
7781538	51	162.525
7781964	52	162.524
7785196	48	162.529
7787498	52	164.382
7788400	56	162.894
7789185	49	161.476
7792009	57	162.516
7798609	60	163.609
7799839	57	162.905
10707524	48	162.528
11877207	48	161.453
14115960	68	162.244
14116890	50	162.465
14186880	64	163.093
14187880	65	162.378
14188282	64	162.227
14188380	64	162.229
14188971	51	161.701
14191180	65	162.379
14191280	64	162.714
14201980	68	162.238
14202383	69	162.534
14202782	69	162.242
14202985	69	162.243
14203587	69	163.219
14203680	68	162.545
14211580	69	162.240
14215480	68	162.326
14216080	67	162.368
14216087	67	162.368
14222380	69	162.928
14222581	69	162.718
14228471	51	161.759
14341000	58	162.251
14368974	51	161.411
14565987	66	163.216
14578082	61	162.427
14578180	61	162.870
14589887	66	163.971
14591987	53	163.837
14592587	66	162.493
14593487	66	163.494
14660690	49	161.457

FIAT		
Ref. Adaptable	pag.	Triclo
15624411	51	162.439
15681000	58	162.250
15690307	48	162.710
15691007	48	161.453
16043324	49	162.363
17894580	68	162.238
18770424	48	162.528
18772114	49	161.705
42536208	58	173.080
46306526	64	162.227
46401657	48	161.753
46401658	49	161.754
46403322	67	162.891
46408953	68	162.887
46410400	65	162.399
46419734	48	161.752
46421193	48	161.758
46424310	67	162.911
46425772	57	162.899
46427367	56	162.514
46428157	51	161.485
46436251	60	162.897
46440164	59	162.720
46459200	64	162.895
46461781	59	162.720
46473571	51	162.444
46474945	61	163.500
46478225	67	162.902
46524246	64	162.896
46541864	53	162.965
46558337	68	162.966
46738532	69	162.977
46748771	68	162.887
46765852	54	190.037
46776048	60	163.053
46776091	65	162.976
46777315	68	163.498
46786189	64	163.093
46790807	50	161.751
46796761	60	163.492
46797755	53	190.364
46804433	57	163.495
46821846	55	190.048
46829200	65	163.221
46835626	65	163.399
46842097	66	163.099
46847980	55	190.049
50504884	67	163.830
51702444	55	190.039
51704854	57	163.220

# INDICE - ref. ADAPTABLE

FIAT		
Ref. Adaptable	pag.	Triclo
51708640	64	163.499
51721582	69	163.966
51723187	68	163.218
51754057	63	162.624
51756677	63	163.610
51761163	63	163.140
51779614	69	163.398
51780607	63	163.973
51786776	56	163.946
51786777	56	163.947
51819230	53	163.852
51831913	65	163.965
60502080	67	163.970
60503610	66	162.354
60503854	54	190.001
60506575	66	162.815
60507674	50	163.097
60509945	69	162.725
60517025	50	163.095
60528009	59	162.351
60584337	50	163.096
60594191	64	163.808
60600860	65	162.399
60607024	57	162.898
60652498	48	161.475
60655007	60	163.025
60660554	64	163.094
60664928	60	163.025
60697869	53	163.920
60805802	56	162.403
60808479	51	161.464
60811807	51	162.442
60812237	52	181.416
71717421	62	162.944
71719636	53	190.351
71728628	55	190.040
71728805	62	163.098
71728806	62	163.052
71738386	65	163.399
71741883	63	163.476
71741894	63	163.814
71747674	65	163.608
71748293	65	163.967
76778650	67	162.369
82377183	64	162.714
82377992	61	162.873
82406852	67	163.496
82412036	66	162.660
82415302	60	162.305
82421028	63	162.517

FIAT		
Ref. Adaptable	pag.	Triclo
82422490	67	162.902
82428097	56	162.404
82435506	50	163.095
82457328	57	162.516
82467481	57	162.898
82468243	68	162.326
82488491	51	161.459
83468353	68	162.244
83468453	69	162.928
92511089	64	162.227
182036080	54	190.028
500326896	62	162.993
500327002	62	163.011
500327004	55	190.049
500339745	62	162.992
500358569	63	163.299
500380712	68	163.611
500389689	67	163.222
504001603	57	162.898
504010315	66	163.009
504056662	63	162.517
504085696	53	163.425
718115080	66	163.945
735266957	66	162.908
735274992	55	190.047
735277664	54	190.029
735293986	66	163.497
735306873	55	190.055
735311599	55	190.052
735316328	55	190.053
735322933	55	190.054
735337771	55	190.051
735354534	55	190.050
735360838	54	190.038
735366395	66	163.217
735430175	66	163.972
735493588	66	163.964
735500166	65	163.968
1301019650	66	162.512
1301155080	54	190.033
1301788650	66	162.512
1301788800	66	162.512
1314167080	53	163.867
1357450080	63	163.963
7352905437	66	163.969
9601120180	53	190.358
9605146380	67	162.880
9612358180	53	190.360
9620669780	62	162.964
9621385880	63	162.979

FIAT		
Ref. Adaptable	pag.	Triclo
9621837480	63	163.303
9632162280	58	171.434
9790337080	61	163.034

FORD		
Ref. Adaptable	pag.	Triclo
1 007 932	79	162.957
1 008 068	77	162.847
1 018 433	78	162.382
1 018 434	78	162.910
1 019 377	80	163.351
1 020 193	76	163.683
1 020 732	77	163.013
1 022 510	73	163.133
1 023 253	73	163.915
1 027 000	80	162.963
1 028 521	79	163.734
1 029 182	77	163.721
1 031 769	76	162.951
1 038 008	76	162.950
1 039 463	79	163.091
1 041 646	77	163.914
1 041 664	74	173.080
1 042 065	82	163.684
1 044 806	77	163.090
1 047 847	78	162.954
1 051 701	82	162.952
1 060 318	81	163.368
1 060 382	80	163.767
1 065 204	76	162.844
1 070 107	77	162.973
1 073 073	80	163.921
1 077 106	70	164.685
1 077 453	72	190.071
1 079 129	78	162.782
1 084 756	71	161.771
1 088 761	79	163.369
1 097 787	77	163.900
1 104 880	79	162.373
1 106 903	73	163.018
1 125 799	79	163.735
1 128 772	74	163.766
1 144 718	76	163.960
1 208 973	77	163.682
1 209 387	72	190.382
1 214 485	77	163.681
1 216 747	82	163.765
1 251 866	74	163.440
1 257 376	77	163.441

FORD		
Ref. Adaptable	pag.	Triclo
1 324 270	74	163.508
1 324 866	79	163.306
1 335 795	80	163.439
1 355 124	72	190.359
1 360 385	76	163.685
1 370 597	78	163.129
1 387 954	76	163.754
1 404 820	72	190.070
1 416 795	80	162.238
1 424 916	76	163.686
1 429 935	79	163.171
1 442 176	72	190.069
1 443 038	82	162.423
1 470 997	70	162.556
1 473 084	70	162.556
1 474 663	71	161.409
1 500 238	74	162.257
1 503 837	71	161.414
1 514 079	72	190.359
1 552 662	77	163.682
1 580 312	81	163.830
1 591 426	76	162.548
1 629 549	79	162.852
1 629 999	82	163.016
1 634 125	80	162.851
1 639 908	79	163.918
1 647 309	70	162.384
1 648 812	82	181.404
1 659 672	80	162.480
1 716 235	71	161.492
114301ES	80	162.238
1S7117K624FE	72	190.359
1S7X8C162AA	79	163.735
2 022 203	70	162.556
2 026 706	70	162.555
2M2113K082AA	72	190.382
2N11-17666-AD	72	190.069
3 680 267	73	163.641
3 865 953	77	162.847
3014E7902358AFA	82	162.423
3M51-17666-AD	72	190.070
3M51-28774-BB	76	163.685
4 046 124	77	162.372
4 052 617	78	163.744
4 069 906	73	163.021
4 069 907	73	163.022
4 097 718	76	163.741
4 494 055	73	163.021
4 494 056	73	163.022
4 605 824	79	163.442



# INDICE - ref. ADAPTABLE

FORD		
Ref. Adaptable	pag.	Triclo
4 740 548	78	163.878
4 860 409	77	163.594
4M5113N060AA	74	163.508
6 028 434	70	162.362
6 040 784	82	162.261
6 053 937	82	162.262
6 068 981	82	163.233
6 077 150	70	162.556
6 078 784	81	162.811
6 084 040	81	163.443
6 099 812	77	162.231
6 103 426	71	161.499
6 105 034	82	162.918
6 114 021	73	162.812
6 114 021	79	162.812
6 117 693	76	161.420
6 140 949	72	190.365
6 142 786	76	162.385
6 150 260	80	162.955
6 156 396	74	163.180
6 156 396	80	163.180
6 163 974	72	190.007
6 176 723	77	162.810
6 180 955	82	162.972
6 181 023	79	162.958
6 183 092	82	162.651
6 184 715	74	162.282
6 185 845	81	162.956
6 186 659	74	162.299
6 186 660	74	162.298
6 195 721	80	163.298
6 314 544	71	161.747
6 549 354	80	163.367
6 560 532	78	163.742
6 634 877	81	162.949
6 659 902	74	163.505
6 678 518	78	162.658
6 695 013	80	162.715
6 715 468	70	161.461
6 717 617	78	163.722
6 725 950	78	162.383
6 740 771	71	161.740
6 743 363	79	162.852
6 758 612	82	162.971
6 781 549	73	163.613
6 781 550	73	163.023
6 786 759	78	162.959
6 866 257	78	162.878
6 870 622	82	163.016
6 877 869	76	163.683

FORD		
Ref. Adaptable	pag.	Triclo
6 974 009	73	163.133
6 998 849	78	162.782
7 003 177	72	190.366
7 003 178	72	190.367
7 200 671	79	162.632
7 222 079	72	190.368
7 723 510	77	162.405
81AG13N129AA	81	162.811
82GG14197D2A	82	162.918
83BB17K624AA	72	190.365
87BBA46812AYYB7	82	181.404
87BG13N129AA	74	163.180
87BG13N129AA	80	163.180
89FG13B128CA	74	162.282
89FG13K040DA	74	162.299
89FG13K040EA	74	162.298
89FG-17666-AA	72	190.007
8A61A02737AA	79	163.918
90BG17K657AA	80	163.367
91AG14197AFA	82	162.972
93BB17K624AA	72	190.366
93BB17K624BA	72	190.367
93BBF030A12AE	73	163.133
95VW13K193CA	74	173.080
95VW17K624AA	72	190.368
95VW257K42AA	76	162.844
95VWA03836CA	73	163.915
95VWA310A46DB	77	162.847
96 FG 17666 AA	72	190.008
96FG16K262AA	79	162.957
97KB17N800AE	77	163.914
98AB030A12AB	73	163.641
98KG-17666-AA	72	190.071
E623300S71	71	161.409
E642280S	70	162.362
E8224125S81	71	161.499
E826110S	74	162.257
E826163S	80	162.955
E826222S	81	163.443
E826292S	80	162.851
E844072S	79	162.958
E864164S	73	162.812
E864164S	79	162.812
E864181S	76	162.385
E864338S	81	162.956
E865063S	77	162.231
E865220S	76	162.953
E865682S	77	162.810
E866061SSYNB	78	162.381
E866061SSYNB	78	162.960

FORD		
Ref. Adaptable	pag.	Triclo
E866202SSYNB3	78	162.383
W303562	81	163.830
W700078S300	80	163.298
W700185S300	78	163.742
W700578S300	80	162.715
W700615S300	79	162.852
W700641S301	70	161.461
W700671S300	78	162.658
W700673S300	78	163.722
W700895S300	74	163.505
W700930S300	82	162.971
W700980S300	81	162.949
W701054S300	79	163.734
W701221S300	73	163.613
W701223S300	73	163.023
W702087S300	80	162.963
W702122S300	78	162.959
W702846S300	78	162.782
W702985S300	82	163.684
W703069S300	81	163.368
W703475S300	73	163.018
W703829S300	80	163.767
W704128SSYYJ6	78	163.129
W704165S300	77	163.090
W704218SSMJCP	78	162.382
W704218SSYEDQ	78	162.910
W704258S300	76	163.683
W704294S300	78	162.954
W704309S300	76	162.950
W704402	77	163.013
W704408S300	80	163.351
W704411S300	76	162.951
W704433S300	79	163.091
W704453S300	77	163.721
W705254S300	77	162.372
W705364S300	76	163.741
W706006S300	80	163.921
W706066S301	71	161.771
W706160S309	70	164.685
W706182S300	79	163.369
W706236S300	77	163.900
W706358S300	78	163.744
W707612S300	74	163.766
W708355S300	76	163.960
W709004S300	77	163.441
W709010S300	77	163.682
W709011S300	77	163.681
W709046S300	82	163.765
W709176S300	79	163.442
W709571S300	78	163.878

FORD		
Ref. Adaptable	pag.	Triclo
W709688S300	74	163.440
W709859S300	80	163.439
W709987S300	79	163.306
W711022S300	76	163.686
W711712S300	79	163.171
W712417S300	76	163.754
W713489S300	77	163.594
YC15B03180AB	73	163.021
YC15B03180BB	73	163.022

HONDA		
Ref. Adaptable	pag.	Triclo
906666890030	84	163.173
38993-634-810	83	163.516
75522-611-000	84	163.172
75522-611-003	84	163.172
75806- SN7-E05	83	190.365
76806-SH3-003	83	190.363
76806-SV5-A02	83	190.363
90505-SX0-003	85	163.813
90656-671-631	84	163.192
90661-SC7-003	84	163.520
90662-SB2-003	84	163.519
90664-671-003	84	163.294
90672-671-003	84	163.618
90672-671-811	84	163.281
90674-SK3-E00	84	163.618
90687-SB0-003	85	163.168
90688-SB0-003	85	163.169
90688-SB0-013	85	163.169
91501-S04-003	85	163.171
91502-SP0-003	85	163.163
91503-SP0-003	85	163.037
91503-SZ3-003	85	163.164
91503-SZ5-003	85	163.802
91508-SM4-003	85	163.036
91508-SR3-000	85	163.170
91511-ST3-E00	83	163.131
91512-SM4-003	85	163.035
91513-SM4-000	84	163.804
91515-SR3-000	83	163.124
91517 SJ4 003	83	162.947
91518-SM4-003	84	163.896
91520-SR3-003	83	163.123
91525-SM4-003	83	163.132
91530-ST5-003	84	163.191
91545-SE0-003	85	163.277
91545-SE0-003	85	163.482
91560-S6A-003	83	163.518

# INDICE - ref. ADAPTABLE

HONDA		
Ref. Adaptable	pag.	Triclo
91560-S9A-A01	83	163.517
91560-S9A-A51	83	163.515
91560-SP0-003	83	163.805
91568-SR2-003	84	163.812
91570-SJD-003	83	163.957
91606-SE3-003	84	163.174

HYUNDAI / KIA		
Ref. Adaptable	pag.	Triclo
81126-37010	86	163.976
82132-27100	86	163.703
82134-22000	86	163.700
82134-37000	86	163.702
82315-27000	87	163.962
82315-33010	87	163.962
82315-33020	87	163.962
82315-38000	87	163.962
82852-28000	86	163.701
85744-28000	87	163.689
86438-27100	86	163.704
86590-28000	86	163.503
86848-22000	87	163.688
87702-H1000	87	163.692
87703-H1000	87	163.693
87719-02500	87	163.695
87756-1C000	87	163.690
87756-2E000	87	163.696
87756-35000	87	163.691
87756-38000	87	163.699
87758-35000	87	163.892
87758-39000	87	163.697
87759-27000	87	163.698
87770-02000	87	163.694
87770-28000	87	163.266
97519-22000	87	163.281
98510-29600	86	190.363
98510-3B000	86	190.365

LEXUS		
Ref. Adaptable	pag.	Triclo
52161-16010	89	163.358
53879-14010	89	163.160
53879-60010	89	163.249
56115-30100	88	163.359
56116-22050	88	163.706
62955-12010	89	163.528
67771-12050	88	163.250
75395-33030	89	163.527

LEXUS		
Ref. Adaptable	pag.	Triclo
75397-48030	89	163.526
75545-53010	88	163.650
75819-12040	88	163.251
90189-06013	89	163.165
90467-05096	88	163.356
90467-07164	89	163.476
90467-07166	89	163.167
90467-07183	89	163.530
90467-07201	89	163.529
90467-08011	88	163.259
90467-08124	88	163.193
90467-08185	89	163.166
90467-09050	88	163.258
90467-09093	89	163.296
90467-09128	89	163.981
90467-09189	89	163.297
90467-10161	88	163.161
90467-10162	88	163.162
90467-10167	88	163.621

MAZDA		
Ref. Adaptable	pag.	Triclo
9926-40-426	90	163.521
9926-40-543A	90	163.522
9926-50-625	90	163.503
9927-40-825	90	163.531
9991-00-412	90	163.172
9991-00-501	90	163.275
9X706182X0	90	163.369
B455-56-143	90	163.474
D20150797	90	163.803
FB01-67-482	90	190.363
GA2K-68-AB1	90	163.472
GA7B-50-797A	90	163.473
H001-50-841	90	163.520
HA01-50-609	90	163.507
HA01-50-609A	90	163.507
LA01-67-482	90	190.363

MERCEDES		
Ref. Adaptable	pag.	Triclo
000 988 15 81	96	162.746
000 988 44 25	96	163.410
000 988 52 25	96	163.283
000 988 55 81	96	163.857
000 990 22 92	98	163.926
000 990 29 92	99	162.373
000 990 34 92	98	162.456

MERCEDES		
Ref. Adaptable	pag.	Triclo
000 990 37 92	99	163.927
000 990 44 92	98	163.793
000 990 45 29	99	163.198
000 990 54 92	99	163.044
000 990 55 92	98	163.305
000 990 57 92	97	163.789
000 990 68 36	91	161.743
000 991 04 98	97	163.790
000 991 24 98	97	163.831
000 991 27 71	97	163.408
000 991 39 40	99	163.409
000 991 58 71	93	163.943
000 991 86 98	97	163.791
000 994 01 45	91	161.414
000 994 05 45	91	161.498
000 994 09 45	91	161.747
000 994 14 45	91	161.702
000 994 25 45	91	161.493
000 994 42 45	91	161.757
000 994 47 45	91	161.746
000 997 06 02	97	163.424
000 997 13 86	92	163.406
001 318 53 58	96	162.746
001 988 09 81	97	163.787
001 988 10 81	97	163.786
001 988 20 81	96	162.913
001 988 27 81	96	163.419
001 988 29 81	96	162.738
001 988 31 81	95	163.285
001 988 32 81	95	163.420
001 988 36 81	95	163.411
001 988 44 81	94	162.739
001 988 45 81	94	162.752
001 988 46 81	94	162.737
001 988 47 81	94	162.749
001 988 48 81	94	162.736
001 988 49 81	94	162.748
001 988 49 81	96	162.738
001 988 50 81	94	162.741
001 988 51 81	94	162.747
001 988 56 81	95	163.778
001 988 57 81	95	163.416
001 988 60 81	94	162.735
001 988 63 81	94	162.740
001 988 76 81	96	163.284
001 988 77 81	96	163.418
001 988 80 81	95	163.100
001 988 97 81	95	163.782
001 990 01 92	99	163.780
001 994 04 45	91	161.487

MERCEDES		
Ref. Adaptable	pag.	Triclo
001 994 41 45	99	162.505
001 994 54 45	91	161.757
001 997 95 86	98	163.856
002 988 51 81	98	163.907
002 994 20 45	91	161.703
002 994 44 45	95	163.415
002 994 64 45	95	163.413
002 994 65 45	95	163.414
002 994 75 45	95	163.421
002 994 80 45	91	161.749
002 997 02 86	95	163.423
003 988 41 78	97	163.282
003 990 02 51	96	163.288
003 994 42 45	91	161.703
004 994 31 45	91	161.748
005 988 72 78	95	163.781
005 988 82 78	97	163.861
006 988 30 78	94	162.744
006 988 35 78	94	162.751
006 988 43 78	97	162.953
006 988 57 78	97	163.773
006 988 72 78	94	163.286
006 988 75 78	94	163.853
006 988 76 78	94	163.854
007 988 71 78	94	162.734
007 988 73 78	95	163.102
007 988 74 78	95	163.101
007 988 76 78	95	163.103
008 988 73 78	93	163.464
009 988 16 78	93	163.784
009 997 72 81	98	163.779
011 988 28 78	95	163.785
011 988 94 78	93	163.909
012 988 60 78	93	163.463
123 990 00 92	99	163.925
123 990 01 36	91	161.474
123 990 02 92	99	163.014
123 990 05 92	93	163.640
123 990 05 92	99	163.640
123 994 01 45	91	161.487
124 988 04 78	94	162.733
124 990 00 52	94	163.412
124 990 04 92	99	163.235
124 990 05 92	98	163.792
124 990 90 51	98	163.792
126 990 03 92	93	163.640
126 990 03 92	99	163.640
126 994 12 45	91	161.746
129 869 00 21	92	190.371
140 698 01 60	95	163.422

# INDICE - ref. ADAPTABLE

MERCEDES		
Ref. Adaptable	pag.	Triclo
140 869 02 21	92	190.370
140 994 10 45	91	161.492
163 988 16 78	97	163.795
163 990 02 92	99	163.924
201 698 01 60	93	162.730
201 698 02 60	93	162.732
201 698 06 60	93	162.731
201 988 03 78	94	162.745
201 990 00 50	96	163.287
201 990 02 92	99	163.069
202 869 00 21	92	190.352
202 869 01 21	92	190.370
202 869 02 21	92	190.355
202 988 04 81	96	163.417
203 690 00 13	93	163.783
203 997 01 86	98	163.855
204 690 06 14	93	163.908
204 866 02 21	92	190.378
210 690 02 13	93	163.461
210 869 10 21	92	190.353
211 988 00 81	93	163.462
463 988 02 78	97	163.407
601 078 20 41	92	163.405
631 984 25 61	97	162.753
631 997 23 86	96	163.788
638 690 00 13	96	163.768
638 695 01 09	96	163.833
638 695 01 14	96	163.833
638 984 00 61	97	162.934
638 984 01 61	97	162.554
638 984 02 61	98	162.259
638 984 08 61	93	162.919
638 984 09 61	93	163.537
638 984 13 61	97	162.453
638 984 16 61	97	162.934
638 988 02 25	96	162.238
638 988 09 78	97	163.771
638 990 04 92	99	162.424
638 990 15 92	99	163.487
638 994 08 45	96	163.063

MINI		
Ref. Adaptable	pag.	Triclo
07 12 9 901 746	102	161.774
07 12 9 925 770	102	161.774
07 13 0 561 277	101	163.845
07 13 0 702 516	100	163.846
07 13 0 702 966	101	163.037
07 13 1 480 418	100	163.623
07 13 1 480 419	100	163.628
07 13 1 490 537	100	163.651
07 13 1 503 417	101	163.754
07 13 2 757 821	100	163.860
07 13 7 036 159	100	163.626
07 13 7 036 160	101	163.624
07 13 7 073 915	100	163.627
07 14 6 981 767	102	161.772
07 14 7 054 461	102	161.785
07 14 7 145 753	101	163.753
07 17 7 141 218	101	163.849
16 13 1 176 747	100	162.948
16 13 1 176 747	100	163.288
51 11 1 908 077	101	163.044
51 11 8 174 185	101	163.045
51 13 2 754 667	101	163.864
51 13 7 034 022	101	163.625
51 13 7 058 122	100	163.836
51 13 7 127 001	101	163.636
51 13 9 804 996	101	163.727
51 16 1 943 122	100	163.454
51 18 8 242 692	100	163.847
51 18 8 242 693	100	163.848
51 25 2 753 575	101	163.823
51 31 7 046 633	100	163.652
51 31 7 111 933	100	163.653
51 33 7 140 714	101	163.826
51 36 7 044 615	100	163.759
51 36 7 044 616	100	163.758
51 41 2 756 212	102	161.783
51 41 8 224 768	101	163.750
51 41 8 224 781	101	163.752
51 43 7 001 491	101	163.843
51 47 1 911 992	101	163.069
51 49 8 123 832	101	161.420
51 71 1 496 621	101	163.629
51 71 8 212 148	102	161.715
51 71 8 212 164	102	161.772
61 66 2 755 722	102	190.068
61 66 2 756 194	102	190.067
61 66 7 146 377	102	190.065
61 66 7 146 378	102	190.066
67 12 8 377 987	102	190.378

MITSUBISHI		
Ref. Adaptable	pag.	Triclo
M-283083	103	163.649
M-293328	103	163.274
M-820141	103	163.069
MB-115492	103	163.267
MB-138567	103	163.539
MB-253964	103	163.269
MB-286961	103	190.363
MB-313984	103	163.273
MB-344789	103	163.272
MB-358361	103	190.365
MB-476821	103	163.300
MB-814152	103	163.977
MB-814154	103	163.832
MR-155254	103	190.363
MR-215510	103	163.270
MR-288150	103	163.271
MR-328954	103	163.482
MR-447362	103	163.643
MS-480002	103	163.538
MU-480033	103	163.268

NISSAN		
Ref. Adaptable	pag.	Triclo
01281-00231	104	163.268
01515-00QAB	105	163.088
01552-00661	104	163.480
01553-00051	105	163.280
01553-01342	104	163.157
01553-01A50	105	163.481
01553-02903	104	163.156
01553-02923	104	163.120
01553-05751	104	163.158
01553-06721	105	163.815
01553-07111	105	163.807
01553-07381	105	163.806
01553-0801M	105	162.910
01553-08101	105	163.483
01553-08371	105	163.806
01553-09241	105	163.276
01553-09321	105	163.482
01553-09321	105	163.802
01553-09611	105	163.166
01651-00481	104	163.520
26399-3J110	104	163.279
286056-AU300	104	176.213
28920-50Y00	104	190.384
28920-BU010	104	190.388
62318-0T001	104	163.155

NISSAN		
Ref. Adaptable	pag.	Triclo
62698-V7000	104	163.484
63848-01G00	105	163.277
63854-01A00	105	163.278
65846-30F00	104	163.615
66820-9F900	104	163.904
67898-U7400	104	163.484
80999-VE000	105	163.806
84953-AU100	105	163.807
SS-06-0364A	104	162.817
SS-07-0069A	105	162.934

OPEL		
Ref. Adaptable	pag.	Triclo
9114735	109	163.930
9114743	111	163.332
9130754	115	163.054
9131114	109	162.938
9131181	109	163.642
9133594	110	163.435
9161907	114	163.222
9177065	111	163.434
9185662	109	163.901
9197915	108	190.012
9216439	109	163.852
11071511	106	161.474
11074603	107	162.712
11090592	107	161.427
11093351	106	162.555
11094002	107	161.756
11095121	107	162.711
13129840	112	178.098
13142042	112	173.197
13154960	106	161.781
13155024	109	163.431
13240067	114	162.903
13265959	113	163.919
24405739	110	163.899
24405740	110	163.876
24417039	114	163.897
24449408	114	163.898
90022049	113	163.902
90033713	106	162.362
90040750	113	163.079
90045820	108	190.371
90053225	107	161.745
90053803	114	163.916
90058826	115	162.819
90082231	113	162.782
90087290	115	162.373

# INDICE - ref. ADAPTABLE

OPEL		
Ref. Adaptable	pag.	Triclo
90087621	108	190.010
90116376	115	163.305
90119995	110	162.319
90123504	112	162.345
90127883	114	162.948
90138810	115	163.307
90139015	114	162.974
90181010	112	162.281
90196277	110	163.798
90218614	113	163.066
90230571	107	162.918
90230960	114	163.439
90269693	111	162.853
90283614	113	162.221
90287467	114	163.677
90321121	111	162.410
90321122	111	163.012
90321482	112	162.412
90328384	113	162.222
90328832	115	163.198
90335715	113	163.678
90355604	113	162.970
90356178	108	190.011
90360289	108	190.013
90376175	110	163.799
90377951	114	163.150
90377951	114	163.438
90379945	115	163.085
90386374	112	162.809
90413589	114	163.437
90414659	115	163.047
90414663	111	163.680
90450482	115	163.889
90457899	111	163.064
90467391	115	163.910
90481595	111	163.065
90482706	114	163.039
90492357	108	190.364
90508326	110	163.432
90508327	110	163.433
90508809	115	163.048
90560163	111	163.614
90562265	109	163.732
90562273	113	163.436
90579619	113	162.844
90580707	111	163.911
90580920	109	163.345
90580928	109	163.851
90585761	108	190.373
90585762	108	190.372

OPEL		
Ref. Adaptable	pag.	Triclo
90587517	109	162.937
90588746	110	163.675
90588747	110	163.676
90589557	111	163.679
90590944	110	163.149
90590995	110	162.944
90590996	110	163.430
91169621	115	163.140
91169650	111	162.993
91169651	111	162.826
91169793	115	163.088
93161475	111	163.141
93181418	109	163.425
93348922	109	163.800
94031590	115	163.198
94218027	113	163.159
207217563	107	161.465
01 22 915	111	163.679
01 22 920	111	163.332
01 29 943	111	163.911
01 49 907	111	163.680
01 49 910	111	163.614
01 57 905	113	163.436
01 57 979	113	162.844
01 64 978	110	163.798
01 71 953	114	163.150
01 71 953	114	163.438
01 71 964	110	163.432
01 71 965	110	163.433
01 72 017	110	162.944
01 72 018	110	163.430
01 72 923	110	163.149
01 72 985	111	163.434
01 74 611	111	163.911
01 74 836	110	163.675
01 74 843	110	162.319
01 74 845	110	163.676
01 74 846	110	162.411
01 74 853	110	163.799
01 74 854	111	163.065
01 74 864	111	163.065
01 80 942	114	163.437
01 87 918	109	163.901
01 87 925	109	163.800
01 88 550	109	162.937
01 88 551	109	163.930
01 88 573	109	163.732
01 88 574	109	162.937
01 88 577	109	162.938
01 88 580	109	163.642

OPEL		
Ref. Adaptable	pag.	Triclo
01 88 581	109	163.345
01 88 582	109	163.851
08 17 950	114	163.677
09 12 466	113	163.678
1 64 361	106	162.362
1 74 751	106	162.266
1 80 940	114	162.948
11 04 880	115	162.373
11 04 881	115	163.889
11 04 882	115	163.889
11 10 936	106	161.781
11 44 811	115	163.198
11 62 484	113	163.079
11 62 488	113	162.970
11 62 742	113	163.919
11 80 216	107	163.057
11 80 411	107	163.057
11 88 303	107	161.745
11 90 365	114	162.974
11 90 970	114	163.916
12 07 203	112	178.098
12 16 904	112	162.345
12 16 957	114	163.439
12 17 801	112	162.412
12 18 601	112	162.281
12 18 604	112	162.809
12 22 141	110	163.876
12 35 884	114	163.897
12 88 548	107	162.918
13 20 703	113	163.159
13 20 925	114	162.903
14 00 804	115	163.047
14 00 806	115	163.048
14 04 969	114	163.898
14 06 925	115	163.054
14 06 984	114	163.039
14 50 156	108	190.371
14 50 173	108	190.372
14 50 175	108	190.364
14 50 184	108	190.373
14 50 185	108	190.372
14 51 166	108	190.010
14 51 174	108	190.012
14 51 181	108	190.011
14 51 183	108	190.013
17 19 242	115	162.819
17 19 245	115	163.307
18 10 850	115	163.085
18 24 622	107	162.874
20 20 005	106	161.474

OPEL		
Ref. Adaptable	pag.	Triclo
20 22 107	106	162.555
20 22 203	106	162.556
20 26 706	106	162.555
20 64 162	107	162.711
20 66 027	107	162.712
20 72 001	107	161.756
20 72 077	107	161.704
20 72 082	107	161.427
22 07 713	113	162.782
22 08 843	113	163.066
22 26 953	113	162.222
22 28 838	110	163.435
22 28 839	110	163.899
22 40 582	111	162.410
22 40 587	111	162.410
22 40 861	113	163.902
22 65 571	115	163.910
23 17 703	115	163.305
23 38 961	113	162.221
23 40 950	111	162.853
23 45 957	111	163.012
23 45 959	111	163.064
23 46 824	113	162.221
44 12 053	111	162.993
44 13 420	115	163.088
44 14 666	115	163.140
44 14 667	111	162.826
44 14 720	111	163.141
44 15 522	109	163.425
44 30 858	111	163.141
45 00 292	109	163.425
45 01 607	114	163.222
47 07 662	109	163.852
51 04 988	109	163.431
62 07 109	112	173.197
73 51 804	109	163.800

# INDICE - ref. ADAPTABLE

P.S.A		
Ref. Adaptable	pag.	Triclo
95556738	126	162.349
95564656	122	162.832
95571660	126	162.347
95583069	122	162.831
95598693	122	162.755
95634217	122	162.650
96048533	128	162.855
96082019	123	162.757
96084939	118	190.026
96090463	123	162.756
96206697	126	162.964
9609212380	132	162.446
9615453880	128	162.372
9639570480	132	163.135
9699575280	130	162.941
0137.11	120	163.032
0137.23	120	163.200
0137.68	120	163.200
1539.16	134	162.906
6212.57	122	163.331
6212.58	122	163.330
6224.69	123	162.758
6224.79	123	162.757
6224.81	123	162.830
6224.C0	123	171.434
6224.L1	123	171.433
6225.66	122	162.832
6347.47	122	163.633
6405.W3	118	190.041
6434.22	119	190.385
6434.46	119	190.357
6434.58	119	190.358
6434.60	119	190.360
6434.66	119	190.357
6434.67	119	190.383
6434.70	119	190.376
6434.75	119	190.361
6434.76	119	190.388
6438.67	118	190.057
6438.71	118	190.025
6438.89	118	190.035
6438.97	118	190.043
6438.A0	118	190.026
6438.F1	118	190.034
6438.F2	118	190.045
6438.P4	118	190.042
6545.86	122	163.631
6547.20	130	163.326
6555.LE	134	163.485
6555.N7	120	163.913

P.S.A		
Ref. Adaptable	pag.	Triclo
6822.LL	129	163.161
6822.N2	135	163.529
6822.N3	135	163.166
6822.N5	130	163.258
6822.N7	135	163.981
6822.NK	135	163.167
6823.54	121	163.912
6922.54	116	161.730
6922.H3	116	161.723
6924.C1	116	161.721
6925.N0	116	161.761
6943.65	124	161.470
6966.33	130	163.086
6966.34	130	162.806
6966.39	129	162.980
6966.40	131	162.935
6972.02	134	162.389
6972.07	134	162.431
6972.24	121	163.717
6972.24	134	163.717
6973.05	116	161.606
6973.34	135	162.341
6973.46	134	162.624
6973.A4	116	161.481
6979.C6	127	162.501
6983.17	131	162.657
6986.A8	120	163.880
6987.A7	133	162.237
6990.50	129	162.803
6990.81	117	163.724
6990.E0	132	163.135
6991.39	133	163.377
6991.E8	129	162.980
6991.F4	128	162.987
6991.F5	128	162.988
6991.F6	128	162.989
6991.G0	124	162.983
6991.N4	127	162.501
6991.P2	133	162.887
6991.S6	121	163.082
6991.S6	129	163.082
6991.S9	129	163.708
6991.T3	129	163.234
6991.X7	135	163.085
6991.Y8	129	163.083
6992.15	124	161.471
6992.18	135	162.708
6992.31	131	162.440
6992.51	128	162.372
6992.66	131	162.453

P.S.A		
Ref. Adaptable	pag.	Triclo
6992.78	131	163.630
6992.80	133	162.523
6992.82	128	162.667
6992.87	133	162.371
6992.93	129	161.421
6992.95	130	162.806
6992.C6	130	163.308
6992.G2	133	162.244
6992.J4	128	162.855
6992.K8	132	162.880
6992.P3	118	162.814
6992.S2	132	163.376
6992.T0	126	162.347
6992.V7	120	162.879
6993.A1	118	163.323
6995.02	128	162.633
6995.15	131	162.454
6995.40	131	163.887
6995.87	126	162.984
6995.A3	128	162.372
6995.N3	132	163.634
6995.N4	133	163.635
6995.N7	132	162.446
6995.S0	128	162.978
6995.V6	130	163.017
6995.X2	118	163.885
6995.X3	127	162.805
6995.Y5	128	162.981
6996.28	124	161.471
6996.36	128	162.372
6996.45	131	162.441
6997.83	134	162.979
6997.86	132	163.081
6997.96	133	163.222
6997.A9	118	163.728
6997.T2	134	162.979
6999.93	125	162.857
6999.A2	126	162.800
6999.A3	132	162.880
6999.CR	128	162.633
6999.CW	125	162.857
7013.J0	135	163.127
7030.16	117	161.718
7030.17	117	163.375
7030.18	117	161.719
7030.19	117	161.767
7136.A5	133	162.985
7410.E2	133	162.982
7420.47	126	162.692
7427.23	116	161.486

P.S.A		
Ref. Adaptable	pag.	Triclo
7427.23	116	161.722
7427.39	135	163.358
7429.47	116	162.435
7429.48	116	162.436
7437.07	127	162.430
7437.10	130	163.317
7473.FL	121	163.379
7473.FL	127	163.379
7481.GP	132	163.731
75 429 475	117	161.428
75.5109.22	122	162.754
7518.N8	130	162.941
7518.N8	131	162.656
7568.H0	131	163.886
7568.NZ	133	163.881
7584.Z8	131	163.087
7588.VX	130	163.386
7813.24	135	163.014
7813.26	126	163.015
7813.29	135	163.963
7840.L6	126	163.638
7840.L7	126	163.404
7903 077 167	130	162.447
7903 077 172	130	162.942
7903 079 144	124	162.859
7903 081 055	133	162.518
7908.67	120	164.385
7908.F6	120	164.390
7928.31	118	163.888
7928.33	118	163.729
7928.39	118	163.869
7950.59	118	163.723
7979.H8	120	163.495
8110.24	121	163.373
8110.24	127	163.373
8110.25	121	163.713
8120.S6	121	163.867
8123.68	121	163.645
8123.70	121	163.316
8123.88	121	163.312
8123.89	121	163.313
8123.90	121	163.314
8123.91	121	163.315
8123.95	121	163.705
8123.96	121	163.379
8123.96	127	163.379
8123.98	121	163.672
8123.A9	127	163.871
8211.WV	135	163.127
8220.EF	117	163.725

# INDICE - ref. ADAPTABLE

P.S.A		
Ref. Adaptable	pag.	Triclo
8251.FC	133	162.892
8321.26	126	163.716
8321.31	121	163.979
8321.43	126	163.980
8326.N4	130	162.883
8331.38	131	162.512
8336.40	129	162.379
8337.FC	129	163.727
8525.NS	133	163.730
8565.17	132	162.676
8565.20	127	162.876
8565.34	127	162.816
8565.35	127	162.804
8565.40	121	162.967
8565.40	127	162.967
8565.41	126	162.986
8565.43	127	163.052
8565.46	129	163.501
8565.47	132	163.632
8565.48	127	163.309
8565.51	127	163.874
8565.53	135	163.344
8565.55	126	163.374
8565.58	127	163.872
8565.60	127	163.309
8565.62	127	163.870
8565.63	121	162.967
8565.63	127	162.967
8565.68	127	163.873
8659.HQ	132	162.618
8710.67	132	163.179
8710.84	132	163.179
8733.75	120	164.387
8733.88	120	164.388
8733.89	120	164.389
8742.19	117	162.688
8742.G2	129	163.378
8742.Q6	127	163.944
8745.66	121	163.920
8748.C2	134	163.303
8748.Q5	130	163.136
8748.QT	129	163.876
8748.W4	131	162.512
8748.Y6	131	162.512
8964.57	131	162.221
8964.77	131	163.201
9025.J8	132	163.715
9044.44	117	161.720
9147.04	124	163.318
9147.14	124	162.859

P.S.A		
Ref. Adaptable	pag.	Triclo
9147.21	124	163.322
9147.32	124	163.084
9159.A5	125	163.380
9227.23	125	162.856
9227.29	125	162.901
9227.31	124	163.034
9227.51	124	163.176
9313.09	124	162.936
9341.23	128	163.905
9341.PF	121	163.594
9341.PF	129	163.594
9345.ZN	129	163.669
9563 7051	126	162.800
9563 7052	126	162.802
9563 7053	126	162.801
9566 7895	127	162.370
96 004 002 80	117	162.439
96 060 797	121	163.316
96 120 786	128	162.849
96 126 454	128	162.848
96 139 474	128	162.850
9699 5446	126	162.825

RENAULT		
Ref. Adaptable	pag.	Triclo
054000001R	160	163.088
0607 273 300	137	161.432
251 867 299	154	163.115
5001 855 049	155	163.141
6001 546 909	156	163.007
76 8E 608 98 R	143	163.978
7700 081 233	159	163.881
7700 308 815	140	190.036
7700 351 266	142	163.338
7700 412 158	146	163.383
7700 413 545	140	190.032
7700 416 965	146	162.829
7700 428 386	141	190.361
7700 428 390	141	190.388
7700 430 702	141	190.374
7700 431 079	141	190.362
7700 431 079	141	190.376
7700 728 108	140	190.019
7700 757 267	148	162.728
7700 763 006	140	190.016
7700 784 411	140	190.018
7700 784 690	148	162.727
7700 789 274	142	163.310
7700 795 778	140	190.017
7700 801 556	150	162.867

RENAULT		
Ref. Adaptable	pag.	Triclo
7700 801 557	150	162.868
7700 802 336	141	190.377
7700 817 502	146	162.694
7700 818 973	144	162.721
7700 821 295	140	190.020
7700 823 915	140	190.030
7700 834 202	147	163.341
7700 834 203	147	163.340
7700 836 190	158	162.648
7700 838 242	148	162.306
7700 838 380	140	190.060
7700 838 570	142	162.999
7700 838 609	147	163.343
7700 838 610	147	163.342
7700 842 510	146	163.137
7700 843 546	144	164.386
7700 846 208	140	190.063
7700 846 317	140	190.064
7701 030 058	150	162.861
7701 030 059	150	162.426
7701 030 060	150	162.862
7701 035 664	150	162.863
7701 040 837	152	162.682
7701 043 799	152	162.681
7701 044 547	151	163.135
7701 047 661	153	162.962
7701 048 296	153	163.144
7701 048 307	141	190.375
7701 049 008	155	163.142
7701 049 270	153	162.967
7701 049 271	160	163.091
7701 050 072	147	163.126
7701 050 730	153	163.144
7701 050 734	155	163.141
7701 053 507	143	163.671
7701 056 059	153	163.714
7701 056 146	143	163.670
7701 056 846	155	163.082
7701 056 972	144	163.665
7701 057 073	143	163.595
7701 057 073	155	163.595
7701 057 132	155	163.142
7701 058 820	155	163.145
7701 061 133	143	163.737
7701 061 133	154	163.737
7701 061 797	153	163.446
7701 062 542	143	163.673
7701 064 619	142	163.953
7701 070 377	143	163.673
7701 070 605	143	163.720

RENAULT		
Ref. Adaptable	pag.	Triclo
7701 070 813	143	163.858
7701 070 813	155	163.858
7701 206 590	140	190.059
7701 206 591	140	190.061
7701 367 683	143	163.959
7701 397 164	139	162.466
7701 397 195	158	162.675
7701 408 846	152	162.473
7701 408 847	152	162.474
7701 408 860	151	162.475
7701 408 875	150	162.864
7701 408 876	150	162.860
7701 408 877	150	162.865
7703 001 123	136	161.706
7703 001 123	137	162.362
7703 005 065	137	161.728
7703 008 211	137	161.729
7703 016 264	137	162.478
7703 016 405	136	162.702
7703 016 514	137	162.490
7703 017 011	136	161.778
7703 017 087	136	161.769
7703 017 089	136	161.762
7703 017 090	136	161.750
7703 017 097	136	161.777
7703 017 104	136	161.769
7703 017 108	136	161.778
7703 017 138	136	161.777
7703 024 015	137	162.619
7703 026 053	137	161.729
7703 033 107	139	162.712
7703 044 013	139	162.466
7703 044 037	139	161.467
7703 044 058	139	162.375
7703 044 087	139	162.465
7703 044 097	146	163.214
7703 044 101	146	163.215
7703 044 121	139	162.328
7703 044 167	138	161.725
7703 044 172	139	162.466
7703 046 012	138	161.437
7703 046 020	139	161.499
7703 046 032	138	161.496
7703 046 034	139	161.438
7703 046 048	139	162.442
7703 046 049	138	162.479
7703 046 091	139	161.703
7703 046 098	138	161.779
7703 046 143	138	161.779
7703 072 116	160	162.456

# INDICE - ref. ADAPTABLE

RENAULT		
Ref. Adaptable	pag.	Triclo
7703 072 144	160	162.259
7703 072 172	160	162.819
7703 072 220	160	162.424
7703 072 236	160	162.481
7703 072 241	137	162.709
7703 072 261	160	163.487
7703 072 327	160	163.486
7703 072 345	160	163.384
7703 072 352	160	163.328
7703 072 360	160	163.088
7703 072 361	160	163.140
7703 072 502	160	163.306
7703 074 112	151	162.912
7703 077 059	154	162.229
7703 077 066	157	162.454
7703 077 068	157	162.453
7703 077 079	156	162.643
7703 077 080	156	162.705
7703 077 108	154	162.452
7703 077 109	154	162.451
7703 077 111	154	162.372
7703 077 117	156	163.006
7703 077 148	157	162.454
7703 077 153	157	162.934
7703 077 183	154	162.668
7703 077 192	154	162.673
7703 077 193	154	162.234
7703 077 199	145	162.722
7703 077 223	156	162.823
7703 077 225	157	162.656
7703 077 243	154	162.672
7703 077 250	155	161.422
7703 077 256	153	161.423
7703 077 300	142	162.463
7703 077 309	153	162.824
7703 077 341	142	162.472
7703 077 345	154	162.669
7703 077 354	155	162.961
7703 077 356	157	162.934
7703 077 362	152	162.488
7703 077 363	152	162.489
7703 077 368	155	163.141
7703 077 420	153	162.992
7703 077 421	153	162.994
7703 077 422	153	162.993
7703 077 428	142	163.338
7703 077 430	155	162.826
7703 077 434	154	163.043
7703 077 435	157	163.008
7703 077 438	142	162.828

RENAULT		
Ref. Adaptable	pag.	Triclo
7703 077 439	145	163.138
7703 077 441	155	163.139
7703 077 444	156	162.975
7703 077 448	153	162.995
7703 077 453	156	163.327
7703 077 457	154	163.382
7703 077 468	155	163.083
7703 077 469	155	163.083
7703 077 471	156	163.385
7703 077 476	155	163.669
7703 077 477	154	163.876
7703 079 027	150	162.485
7703 079 290	150	162.485
7703 079 328	145	162.723
7703 079 351	144	162.915
7703 079 369	144	162.916
7703 079 714	145	162.724
7703 079 714	150	162.865
7703 079 812	145	163.885
7703 079 870	145	163.223
7703 079562	144	162.914
7703 080 048	152	162.327
7703 081 003	149	162.595
7703 081 013	158	161.424
7703 081 019	159	162.523
7703 081 054	157	162.941
7703 081 056	158	163.320
7703 081 086	159	162.238
7703 081 103	158	162.932
7703 081 134	159	162.483
7703 081 147	159	162.468
7703 081 151	149	162.701
7703 081 155	158	163.363
7703 081 160	159	163.426
7703 081 161	149	162.471
7703 081 163	159	163.427
7703 081 164	159	163.502
7703 081 170	149	162.700
7703 081 176	159	162.933
7703 081 180	147	163.019
7703 081 184	159	162.903
7703 081 185	157	162.222
7703 081 185	159	163.222
7703 081 188	156	162.875
7703 081 190	149	162.700
7703 081 212	149	163.452
7703 081 222	158	163.429
7703 081 224	149	163.362
7703 081 225	159	163.883
7703 081 227	157	163.906

RENAULT		
Ref. Adaptable	pag.	Triclo
7703 081 232	159	163.882
7703 179 010	145	163.224
7703 179 088	145	163.471
7703 602 059	136	161.731
7703 602 206	136	161.724
7703 602 282	136	161.727
7704 002 215	141	190.387
7705 002 130	145	163.366
7705 099 009	142	162.827
8200 012 580	146	163.668
8200 048 881	143	163.868
8200 082 347	140	190.062
8200 138 447	146	163.203
8200 138 448	146	163.202
8200 186 255	155	163.891
8200 222 830	145	163.913
8200 261 818	147	175.225
8200 294 204	143	163.868
8200 302 291	154	163.381
8200 305 109	149	163.146
8200 320 884	142	163.364
8200 333 033	142	163.425
8200 335 703	143	163.674
8200 369 224	153	163.718
8200 369 854	153	163.719
8200 389 607	153	163.504
8200 402 521	147	175.224
8200 501 939	147	175.226
8200 666 724	153	163.718
8200 699 857	153	163.719
8200 939 873	156	163.879
8201 033 717	151	163.225
8201 111 623	143	163.948
8201 112 162	155	163.083

ROVER		
Ref. Adaptable	pag.	Triclo
91508-SM4-003	161	163.036
91520-SR3-003	161	163.123
91525-SM4-003	161	163.132
DCC 10010	161	162.947
DCC 100190	161	163.131
DCC 100190	161	163.169
DCE 10038L	161	163.333
DYC 500020	161	163.639
DYQ 100230	161	163.037
DYQ 100230A	161	163.037

SEAT		
Ref. Adaptable	pag.	Triclo
4255534	164	181.401
4400321	162	190.021
4401310	163	162.563
4432041	162	190.022
4483981	164	181.400
00.04292588	166	162.608
00.04412934	165	162.599
00.04424781	163	162.640
00.04432192	165	162.551
00.04442520	163	162.520
00.04450794	163	162.641
00.04461409	165	162.615
00.04472197	163	162.532
00.05938663	165	162.713
00.05940037	163	162.360
00.05978963	163	162.568
00.08235646	165	162.580
00.92310243	165	162.554
BD-59039600	162	161.425
FA-52143600	162	161.448
FC-55609200	165	162.325
FC-59018000	163	162.679
GA-55819410	165	162.598
HB-56625000	166	162.609
HB-93981000	166	162.491
HH-53008000	166	162.401
JA-53008000	163	162.571
LF-89016600	166	162.610
NG-01746109	166	162.494
NG-20502815	166	162.247
NR-13325821	162	161.440
NR-14187480	165	162.378
NR-14187980	165	162.553
NR-14188880	166	162.449
NR-14199688	166	162.492
NR-14201980	166	162.238
NR-14202383	166	162.534
NR-14202782	166	162.242
NR-14202985	166	162.243
NR-14203080	166	162.457
NR-14203680	166	162.545
NR-14215480	166	162.326
NR-14219290	162	162.564
NR-14574790	166	162.558
NR-14578083	163	162.427
NR-14592587	165	162.493
NR-17670101	162	161.431
SE-021521358A	164	181.431
SE-021521358B	164	181.432
SE-021521359A	164	181.433

# INDICE - ref. ADAPTABLE

SEAT		
Ref. Adaptable	pag.	Triclo
SE-021522358A	164	181.434
SE-021522359A	164	181.435
SE-141563390A	162	161.430

SMART		
Ref. Adaptable	pag.	Triclo
1781V002000000	167	163.339

SUBARU		
Ref. Adaptable	pag.	Triclo
8533012320	167	190.363
8533035070	167	190.363
57728AC090	167	163.276
91017AA010	167	163.477
91017FA010	167	163.479
91017FA080	167	163.478

SUZUKI		
Ref. Adaptable	pag.	Triclo
09409-07303-5ES	168	163.302
09409-07305-5PK	168	163.475
09409-07308-5PK	168	163.300
09409-07325-5PK	168	163.301
09409-07332-000	168	163.476
09409-08320-000	168	163.250
09409-08322-000	168	163.616
09409-10309-000	168	163.617
09409-10312	168	163.161
09409-15302-000	168	163.814
38410-66113	168	190.365
77150-63J10	168	163.866
77553-65D00	168	163.248
77553-65D10	168	163.248
84618-76G10	168	163.852
89422-64920	168	163.531

TOYOTA		
Ref. Adaptable	pag.	Triclo
38410-66113	169	190.365
52155-21010	172	163.524
52155-21020	172	163.523
52155-44010	172	163.525
52161-16010	173	163.358
52535-52012	169	163.352
52536-52012	169	163.353
52565-52010	169	163.895
53145-42010	169	163.246
53879-14010	172	163.160
53879-60010	173	163.249
56115-30100	169	163.359
56116-22050	169	163.706
62955-12010	171	163.528
67771-01010	171	163.531
67771-12010	171	163.531
67771-12050	171	163.250
67771-16170	171	163.253
67771-22010	171	163.533
67771-30070	171	163.620
67867-12150	169	163.122
67867-52010	172	163.355
67921-95501	171	163.532
75392-60031	170	163.933
75394-60030	170	163.935
75395-33030	170	163.527
75397-35010	170	163.931
75397-48030	170	163.526
75492-60020	170	163.936
75493-60020	171	163.534
75494-42010	170	163.247
75495-35010	170	163.934
75498-42010	170	163.932
75545-53010	169	163.650
75548-20110	169	163.130
75819-12040	171	163.251
75881-60010	170	163.937
75882-60010	170	163.939
75883-60010	170	163.938
75884-60010	170	163.940
85310-22080	169	190.363
90189-06003	170	163.121
90189-06005	170	163.255
90189-06006	170	163.256
90189-06010	170	163.619
90189-06013	170	163.165
90189-06042	170	163.520
90189-06224	170	163.894
90189-06226	170	163.622
90467-05096	171	163.356

TOYOTA		
Ref. Adaptable	pag.	Triclo
90467-06017	173	163.503
90467-0616101	172	163.262
90467-06198	173	163.295
90467-07041	173	163.300
90467-07164	173	163.476
90467-07166	173	163.167
90467-07175	172	163.536
90467-07183	173	163.530
90467-07188	169	163.859
90467-07188	173	163.859
90467-07201	173	163.529
90467-08011	172	163.259
90467-08030	172	163.260
90467-08081	172	163.357
90467-08124	172	163.193
90467-08185	173	163.166
90467-0900401	172	163.257
90467-09050	172	163.258
90467-0906901	172	163.261
90467-09084-01	171	163.535
90467-09093	173	163.296
90467-09128	173	163.981
90467-09189	173	163.297
90467-09206	171	163.161
90467-10000	172	163.194
90467-10023	170	163.254
90467-10091	172	163.252
90467-10161	171	163.161
90467-10162	171	163.162
90467-10167	171	163.621
90467-10192	171	163.354
90467-11063	170	163.248
90467-12020	169	163.159
90904-67036	170	163.942
90904-67037	170	163.941

V.A.G.		
Ref. Adaptable	pag.	Triclo
113 857 117 B	200	162.431
155 809 966	198	162.244
161 867 299	201	162.373
165 807 193 B	180	162.295
165 827 592	198	162.776
165 853 674	181	162.834
171 201 969	197	162.923
171 807 249 A	192	162.503
171 807 267	180	162.317
171 837 199	190	163.067
171 853 585	186	162.677
171 853 585 A	186	162.677
171 853 695 A	201	162.665
171 885 767	200	162.505
175 867 949	199	163.211
191 807 193	180	162.403
191 853 577	186	162.500
191 853 585 A	186	162.787
191 853 615 A	197	162.267
191 853 733 A	185	162.689
191 863 447	178	181.405
191 867 199 C	195	162.780
191 867 301 A	195	162.297
191 941 133	183	162.292
191 941 141	183	162.293
191 941 142	183	162.294
191 955 985 A	178	190.031
1C0 867 207	200	162.812
1H0 819 055 B	185	162.759
1H0 819 055 C	185	162.765
1H0 819 055 C	201	162.765
1H0 819 145 B41	200	163.210
1H0 819 946 A	185	162.760
1H0 823 397	182	162.506
1H0 823 499	178	164.379
1H0 823 500 B	178	164.383
1H0 823 717	184	162.920
1H0 837 111 A	184	162.761
1H0 837 223 B	191	181.426
1H0 837 498	190	162.841
1H0 837 719	184	162.844
1H0 853 120	198	162.842
1H0 853 585	187	162.301
1H0 853 585 A	187	162.303
1H0 853 585 B	187	162.302
1H0 853 586	187	163.394
1H0 853 733 B	185	162.690
1H0 853 947	198	162.835
1H0 854 549	181	162.768
1H0 863 850	181	162.840



# INDICE - ref. ADAPTABLE

V.A.G.		
Ref. Adaptable	pag.	Triclo
1H0 867 199	195	162.781
1H0 867 199 A	201	162.766
1H0 867 276 A	196	162.772
1H0 867 276 C	196	162.773
1H0 867 981	195	162.767
1H0 868 243	194	162.300
1H0 868 243 B	194	162.784
1H0 868 244 B	194	162.671
1H0 868 246 A	194	162.670
1H0 868 246 B	194	162.769
1H5 863 849	181	162.845
1H6 955 651	179	190.368
1H6863447B41	178	181.405
1H9 807 250	180	162.839
1J0 853 120	199	163.107
1J0 858 137 A	175	161.766
1J0 858 137 B	175	161.766
1J0 863 119	181	163.189
1J0 867 276 B	196	163.205
1J0 867 646	196	163.207
1J0 941 295 A	183	173.080
1J0 941 295 B	183	173.196
1J6 867 276	175	161.765
1J6 955 651	179	190.353
1J9 867 981	175	161.768
1K0 837 199 B	184	163.824
1K5 955 651	179	190.355
1K5 955 651	179	190.379
1K6 837 200 A	192	163.877
1K6 941 295	183	173.197
1L0 853 934	200	163.329
1L0 867 616	198	162.888
1L0 955 651	179	190.378
1M0 837 720 E	193	163.834
1M0 837 720 F	193	163.835
1M0 853 547 A	200	162.424
1M0 854 541 A	185	162.990
1M0 854 719 A	185	162.991
1M0 867 276	196	163.204
1P0 854 719 B	185	163.637
1P0 864 247	175	161.770
1T0 853 910 A	185	163.710
1U0 837 167 C	191	181.595
1U0 837 167 E	191	181.595
1Z0 837 732 A	193	163.875
251 823 717	184	162.504
251 867 299	192	163.115
311 821 143	174	162.556
311 821 161	176	161.489
311 881 247	175	163.071

V.A.G.		
Ref. Adaptable	pag.	Triclo
321 813 988 A	199	162.716
321 867 299 B	195	162.674
321 867 838	196	162.884
333 867 633 4FB	201	162.843
357 823 397	182	163.175
357 827 998	199	162.833
357 827 998 A	199	163.038
357 853 575	186	162.501
357 853 585	186	162.502
357 853 585 A	186	162.785
357 853 586	186	162.502
357 853 586 D	186	162.786
357 863 119	195	163.129
357 867 300 A	195	163.209
357 867 646	196	162.779
357 868 143	199	162.930
3A0 853 575	187	162.790
3A0 853 575 A	187	162.788
3A0 853 586	197	162.837
3A0 867 301	195	162.297
3B0 837 732	193	163.104
3B0 839 723	193	163.687
3B0 853 575	187	162.789
3B0 853 576	187	162.791
3B0 867 333	186	163.955
3B0 867 334	186	163.956
3B0 868 243	193	162.946
3B0 868 243	193	163.117
3B7 955 681	183	190.382
3B9 863 689	193	163.108
3C0 853 585	186	163.917
3C0 853 586	187	163.884
3C0 867 333	193	163.648
3D0 853 576	186	163.707
3D5 853 707 B	185	163.709
431 955 651	179	190.352
441 955 973 B	197	162.924
443 853 547 B	198	162.562
443 867 299	193	163.073
4A0 805 121 A	177	163.227
4A0 805 121 B	177	161.712
4A0 805 121 C	177	163.319
4A0 805 137 A	177	163.361
4A0 805 163	177	163.228
4A0 805 960	177	161.710
4A0 853 825	187	162.793
4A0 853 825 A	187	162.794
4A0 853 825 C	187	162.792
4A0 853 825 D	187	162.796
4A0 853 825 E	187	162.795

V.A.G.		
Ref. Adaptable	pag.	Triclo
4A0 857 610	199	163.051
4A0 955 651 A	179	190.354
4B0 867 276 A	175	161.482
4D0 807 300	201	163.743
4D0 807 300 B	201	163.074
4D0 853 825 C	187	163.103
4D0 867 299 D	193	163.073
4D0 868 637	197	162.257
4F0 805 121	177	163.540
4F0 825 429 A	197	163.893
4F0 831 719	192	163.954
4G0 827 310	199	163.975
5J0 853 573	185	162.370
5J0 867 276	192	163.740
5P0 810 997	201	163.794
5P0 941 295	183	178.098
5X0 867 299	193	163.469
6J0 821 119	180	163.739
6J0 821 120	180	163.738
6J0 821 120 A	180	163.738
6J0 821 213	201	163.903
6J0 854 719 C	185	163.850
6J0 867 276	196	163.974
6K0 823 397	182	163.175
6K0 823 717	184	163.050
6K0 853 129	181	163.187
6K0 853 578	186	163.184
6K0 853 578 A	186	163.185
6K0 853 578 B	186	163.186
6K0 867 838 A	196	163.177
6K0 868 243	194	163.244
6K0 868 243 A	194	163.245
6K0 868 243 C	193	163.089
6K0 971 898 D	199	301.022
6K0819285 B41	185	163.020
6K3 837 223	191	181.425
6K3 837 223 A	191	181.429
6K4 837 223	191	181.427
6K4 837 223 A	191	181.428
6K5 807 183	180	163.001
6K5 807 184	180	163.000
6K6 863 988	184	162.929
6L0 121 136	200	163.810
6L0 839 720 A	184	163.346
6L6 853 575	185	163.545
6L6 853 575	192	163.545
6L6 853 575 A	185	163.545
6L6 853 575 A	192	163.545
6N0 807 199	174	161.486
6N0 807 199	174	162.397

V.A.G.		
Ref. Adaptable	pag.	Triclo
6N0 809 966 A	198	162.775
6N0 823 397 A	182	162.762
6N0 823 397 C	182	162.762
6N0 827 499	178	164.384
6N0 837 223 A	191	181.440
6N0 839 511	190	163.176
6N0 853 825	181	162.764
6N0 853 826	181	162.763
6N0 867 276	196	163.116
6N3 868 561	196	162.777
6Q0 868 241	193	163.541
6Q0 868 243	193	163.541
6Q0 880 385	192	163.134
6Q0 998 225	182	163.237
6Q0 998 226	182	163.236
6X0 827 951 B	195	163.760
6X0 853 575	181	163.049
6X0 867 300 A	192	163.152
6X0 868 243 A	192	163.072
6X0 998 225	182	163.239
6X0 998 226	182	163.238
6X0867301B01C	194	163.151
701 121 565	178	162.854
701 867 299 01C	201	163.390
701 867 299 U71	201	163.391
701 867 549	193	163.073
703 867 299	192	163.105
7H0 843 514	192	163.755
7H0 843 658 A	192	163.213
7L0 839 069	187	163.395
7L6 868 243	193	163.470
7L6 868 307	200	163.485
7M0 807 181 A	180	162.969
7M0 837 223 A	191	181.441
7M0 853 585 E	184	163.231
7M0 867 299 K	192	162.847
7M0 868 563	195	163.230
7M0 883 069	192	162.230
7M3 853 585	185	163.726
801 867 299	192	162.421
811 807 447	200	162.666
811 807 577 B	198	163.181
811 807 577 C	198	162.331
811 807 577 C	198	162.774
811 863 905 A	192	162.659
811863905D01C	195	162.704
823 867 299	192	162.235
865 853 231 A	197	163.076
867 809 966	198	162.331
867 863 849 A	181	162.846

# INDICE - ref. ADAPTABLE

V.A.G.		
Ref. Adaptable	pag.	Triclo
867 971 928	184	163.183
893 803 593	184	163.190
893 823 740	200	162.664
893 867 290	192	163.106
8D0 803 583 L	184	163.208
8D0 805 121	177	161.708
8D0 805 121 B	177	161.707
8D0 805 960	177	161.709
8D0 807 192	197	163.428
8D0 839 825 A	194	162.877
8D0 853 622	197	163.075
8D0 853 909 B	186	163.148
8E0 805 121 A	177	161.713
8E0 805 960	177	161.711
8E0 825 267	201	163.091
8E0 837 485 C	193	163.396
8E0 863 727 A	181	163.543
8E0 867 276	192	163.154
8E0 868 243	193	163.468
8E0 998 121	182	163.241
8E0 998 122	182	163.240
8E5 853 213	184	163.232
8E9 867 299	192	163.082
8K0 805 121	177	161.780
8K0 805 922 A	177	161.772
8K0 868 307	201	163.756
8L0 807 300	201	163.109
8L0 853 909	186	163.147
8L0 998 121	182	163.242
8L3 837 199 B	184	163.206
8L4 831 720	197	163.188
8N0 951 257	197	162.720
8P0 868 243	193	163.212
8P0 868 243 A	193	163.387
8R0 853 909	186	163.929
8R0 853 909 A	186	163.929
8T0 807 300 A	200	163.757
8Z0 857 784	200	163.485
8Z0 868 243	193	163.117
N 012 062 2	175	161.460
N 015 422 2	176	161.736
N 015 429 1	176	161.484
N 015 429 1	176	161.736
N 015 429 2	176	161.484
N 015 432 2	176	161.465
N 015 437 3	176	161.738
N 015 439 1	176	161.737
N 015 445 2	176	161.498
N 015 458 1	176	161.491
N 038 549 01	201	162.373

V.A.G.		
Ref. Adaptable	pag.	Triclo
N 0385501	201	162.632
N 0386021	175	161.429
N 102 195 01	200	163.305
N 102 195 02	200	163.305
N 103 055 02	175	161.755
N 103 091 01	174	162.702
N 103 546 01	174	161.764
N 105 073 01	198	163.388
N 105 168 01	199	163.178
N 105 791 01	177	163.229
N 10621301	199	163.393
N 901 686 02	176	161.497
N 901 708 01	176	161.418
N 90127883	197	162.948
N 902 184 01	175	162.904
N 902 293 01	201	163.306
N 902 689 01	176	161.427
N 90201601	195	162.782
N 90206501	199	162.429
N 90257703	175	161.459
N 903 350 04	177	161.461
N 904 792 01	175	163.544
N 90474001	197	162.922
N 905 353 01	198	162.783
N 905 426 02	174	162.556
N 906 261 01	175	163.372
N 906 349 01	174	161.650
N 906 987 01	176	161.744
N 906 987 03	176	161.744
N 907 407 01	174	162.397
N 907 468 01	175	161.735
N 907 750 01	174	161.477
N 907 965 02	177	161.782
N 908 131 01	195	163.542
N 908 251 01	176	161.741
N 908 338 01	198	162.885
N 90821401	198	162.836
N 909 591 01	200	163.044
N 910 444 01	198	163.350
N0385011	200	162.821
N0385012	200	162.821
N10259301	200	162.456
N10417901	200	163.961
N9057400101C	184	162.778

VOLVO		
Ref. Adaptable	pag.	Triclo
987789	204	163.300
1224786	204	163.890
1268176	204	163.198
1285015	204	163.225
1325285	202	163.360
1372682	202	163.736
3541113	204	163.277
3545549	204	163.389
3923475	204	163.305
6816180	203	163.764
8622906	203	163.958
8678010	204	163.811
8679426	204	163.470
9133417	204	163.304
9169611	202	190.380
9178094	202	190.379
9190966	203	163.763
9190967	203	163.761
9190970	203	163.762
9190981	202	163.199
9.484.524	202	163.334
30648141	204	163.082
30661329	204	162.959
30678009	202	163.334
30753989	203	163.839
30800957	202	163.335
30800958	202	163.336
30817220	204	163.903
30820141	204	163.069
30864984	203	163.644
30870550	203	163.646
30872551	203	163.647
30873201	202	163.337
30874958	203	163.643
31283805	202	190.359
31304111	203	163.838

	pag	marca	ref.adaptable	U.E.
123.742	164	Seat		1
123.743	164	Seat		1
161.408	52	Fiat	7635984	5
161.409	7	universal		50
	71	Ford	1 474 663	50
	71	Ford	E623300S71	50
161.410	8	universal		50
161.411	8	universal		50
	51	Fiat	14368974	50
161.412	6	universal		100
161.413	6	universal		100
161.414	6	universal		100
	71	Ford	1 503 837	50
161.414	91	Mercedes	000 994 01 45	100
	91	Mercedes	000 994 01 45	100
161.415	6	universal		100
161.418	8	universal		50
	176	VAG	N 901 708 01	50
161.420	43	BMW	51 49 8 123 832	50
	76	Ford	6 117 693	50
	101	Mini	51 49 8 123 832	50
161.421	129	PSA	6992.93	50
161.422	155	Renault	7703 077 250	50
161.423	153	Renault	7703 077 256	100
161.424	158	Renault	7703 081 013	25
161.425	162	Seat	BD-59039600	25
161.426	7	universal		50
161.427	8	universal		50
	36	BMW	23 07 0 22	50
	107	Opel	20 72 082	50
	107	Opel	11090592	50
	138	Renault		50
	176	VAG	N 902 689 01	50
161.428	117	PSA	75 429 475	25
161.429	175	VAG	N 0386021	50
161.430	5	universal		10
	162	Seat	SE-141563390A	10
161.431	3	universal		50
	162	Seat	NR-17670101	50
161.432	3	universal		25
161.436	137	Renault	0607 273 300	25
	9	universal		50
161.436	138	Renault		50
	9	universal		50
161.437	138	Renault	7703 046 012	50
	7	universal		50
161.438	71	Ford		50
	139	Renault	7703 046 034	50
	139	Renault	7703 046 034	50
161.439	2	universal		50
161.440	5	universal		10
	162	Seat	NR-13325821	10
161.441	2	universal		50

	pag	marca	ref.adaptable	U.E.
161.442	2	universal		50
161.443	2	universal		50
161.444	2	universal		50
161.447	7	universal		50
	138	Renault		50
161.448	50	Fiat	4138439	50
	162	Seat	FA-52143600	50
161.449	9	universal		50
	138	Renault		50
161.450	5	universal		10
	137	Renault		10
161.453	3	universal		50
	48	Fiat	11877207	50
161.453	48	Fiat	15691007	50
	48	Fiat	15691007	50
161.454	3	universal		50
	48	Fiat	7751170	50
161.455	5	universal		10
	49	Fiat	7609062	10
161.456	4	universal		25
	49	Fiat	7558952	25
161.457	4	universal		25
	49	Fiat	14660690	25
161.458	4	universal		10
	49	Fiat	7771629	10
161.459	51	Fiat	82488491	25
	175	VAG	N 90257703	25
161.460	175	VAG	N 012 062 2	25
161.461	70	Ford	6 715 468	25
	70	Ford	W700641S301	25
	177	VAG	N 903 350 04	25
161.462	70	Ford		10
161.464	7	universal		50
	51	Fiat	60808479	50
161.464	51	Fiat	7740882	50
	51	Fiat	7740882	50
161.465	9	universal		50
	71	Ford		50
	107	Opel	207217563	50
161.467	176	VAG	N 015 432 2	50
	6	universal		10
161.467	139	Renault	7703 044 037	10
	139	Renault	7703 044 037	10
161.468	6	universal		100
161.469	6	universal		100
161.470	124	PSA	6943.65	25
161.471	124	PSA	6996.28	25
	124	PSA	6992.15	25
161.472	6	universal		100
161.473	3	universal		50
	36	BMW	51 13 1 823 634	50
161.473	70	Ford		50
	91	Mercedes		50
	106	Opel		50

	pag	marca	ref.adaptable	U.E.
161.473	116	PSA		50
	174	VAG		50
161.474	3	universal		50
	36	BMW	07 11 9 916 949	50
	70	Ford		50
	91	Mercedes	123 990 01 36	50
	106	Opel	20 20 005	50
	106	Opel	11071511	50
	116	PSA		50
161.475	174	VAG		50
	4	universal		10
161.475	48	Fiat	60652498	10
	48	Fiat	60652498	10
161.476	5	universal		10
	49	Fiat	7789185	10
161.477	3	universal		50
	174	VAG	N 907 750 01	50
161.478	139	Renault		50
161.479	70	Ford		25
161.481	10	universal		10
	116	PSA	6973.A4	10
161.482	175	VAG	4B0 867 276 A	25
161.483	10	universal		50
161.484	8	universal		50
	176	VAG	N 015 429 1	50
	176	VAG	N 015 429 2	50
161.485	51	Fiat	46428157	25
161.486	4	universal		10
	116	PSA	7427.23	10
	174	VAG	6N0 807 199	10
161.487	7	universal		50
	91	Mercedes	001 994 04 45	50
	91	Mercedes	123 994 01 45	50
161.488	8	universal		50
	51	Fiat	7729424	50
161.489	7	universal		50
	176	VAG	311 821 161	50
161.490	7	universal		50
	36	BMW	07 12 9 925 726	50
161.491	71	Ford		50
	8	universal		50
161.491	176	VAG	N 015 458 1	50
	176	VAG	N 015 458 1	50
161.492	8	universal		50
	71	Ford	1 716 235	50
161.493	91	Mercedes	140 994 10 45	50
	8	universal		50
	36	BMW	07 12 9 925 708	50
161.493	71	Ford		50
	91	Mercedes	000 994 25 45	50
	91	Mercedes	000 994 25 45	50
161.495	8	universal		50
	36	BMW	07 12 9 925 712	50
161.496	8	universal		50

	pag	marca	ref.adaptable	U.E.
161.496	117	PSA		50
	138	Renault	7703 046 032	50
161.497	7	universal		50
	176	VAG	N 901 686 02	50
161.498	8	universal		50
	36	BMW	07 12 9 925 713	50
	36	BMW	07 12 9 901 649	50
	91	Mercedes	000 994 05 45	50
	176	VAG	N 015 445 2	50
161.499	7	universal		50
	71	Ford	6 103 426	50
	71	Ford	E8224125S81	50
	117	PSA		50
	139	Renault	7703 046 020	50
161.500	2	universal		50
161.501	2	universal		50
161.502	2	universal		50
161.503	2	universal		50
161.504	2	universal		50
161.505	2	universal		50
161.506	2	universal		50
161.507	2	universal		50
161.508	2	universal		50
161.509	2	universal		50
161.510	2	universal		50
161.511	2	universal		50
161.512	2	universal		50
161.513	2	universal		50
161.514	2	universal		50
161.600	10	universal		100
161.601	10	universal		100
161.602	10	universal		100
161.603	10	universal		100
161.604	10	universal		100
161.605	10	universal		100
161.606	10	universal		100
	116	PSA	6973.05	100
161.607	10	universal		100
161.608	10	universal		100
161.650	10	universal		100
	174	VAG	N 906 349 01	100
161.651	10	universal		100
161.652	10	universal		100
	137	Renault		100
161.653	10	universal		100
	174	VAG		100
161.654	10	universal		100
161.655	10	universal		100
161.656	10	universal		100
161.701	7	universal		50
	51	Fiat	14188971	50

	pag	marca	ref.adaptable	U.E.
161.702	8	universal		50
	36	BMW	07 12 9 925 737	50
	91	Mercedes	000 994 14 45	50
161.703	7	universal		50
	71	Ford		50
	91	Mercedes	003 994 42 45	50
	91	Mercedes	002 994 20 45	50
	139	Renault	7703 046 091	50
161.704	9	universal		50
	36	BMW	07 12 9 925 720	50
	71	Ford		50
	107	Opel	20 72 077	50
161.705	5	universal		10
	49	Fiat	18772114	10
	137	Renault		10
161.706	4	universal		50
	49	Fiat	7658843	50
	136	Renault	7703 001 123	50
161.707	177	VAG	8D0 805 121 B	10
161.708	177	VAG	8D0 805 121	10
161.709	177	VAG	8D0 805 960	10
161.710	177	VAG	4A0 805 960	10
161.711	177	VAG	8E0 805 960	10
161.712	177	VAG	4A0 805 121 B	10
161.713	177	VAG	8E0 805 121 A	10
161.714	36	BMW	51 71 8 176 503	10
161.715	36	BMW	51 71 8 212 148	10
161.715	102	Mini	51 71 8 212 148	10
161.716	36	BMW	51 71 8 218 323	10
161.717	36	BMW	51 71 8 218 852	10
161.718	117	PSA	7030.16	50
161.719	117	PSA	7030.18	50
161.720	117	PSA	9044.44	50
161.721	3	universal		25
	106	Opel		25
	116	PSA	6924.C1	25
	136	Renault		25
161.722	4	universal		25
	116	PSA	7427.23	25
161.723	5	universal		25
	49	Fiat		25
	116	PSA	6922.H3	25
161.724	4	universal		25
	45	Dacia	7703 602 206	25
	136	Renault	7703 602 206	25
161.725	138	Renault	7703 044 167	10
161.726	138	Renault		10
161.727	4	universal		25
	45	Dacia	7703 602 282	25
	106	Opel		25
	136	Renault	7703 602 282	25

	pag	marca	ref.adaptable	U.E.
161.728	5	universal		10
	137	Renault	7703 005 065	10
161.729	5	universal		10
	137	Renault	7703 026 053	10
	137	Renault	7703 008 211	10
161.730	4	universal		25
	116	PSA	6922.54	25
161.731	5	universal		25
	45	Dacia	7703 602 059	25
	136	Renault	7703 602 059	25
161.732	4	universal		10
	136	Renault		10
161.733	4	universal		10
	136	Renault		10
161.734	4	universal		10
	136	Renault		10
161.735	175	VAG	N 907 468 01	50
161.736	8	universal		50
	176	VAG	N 015 429 1	50
	176	VAG	N 015 422 2	50
161.737	8	universal		50
	176	VAG	N 015 439 1	50
161.738	8	universal		50
	176	VAG	N 015 437 3	50
161.739	3	universal		25
	36	BMW	41 35 8 152 737	25
161.740	7	universal		10
	71	Ford	6 740 771	10
161.741	8	universal		50
	176	VAG	N 908 251 01	50
161.742	3	universal		50
	36	BMW		50
	70	Ford		50
	91	Mercedes		50
161.743	106	Opel		50
	174	VAG		50
	3	universal		50
	36	BMW		50
	70	Ford		50
161.744	91	Mercedes	000 990 68 36	50
	106	Opel		50
	174	VAG		50
161.745	8	universal		50
	176	VAG	N 906 987 03	50
	176	VAG	N 906 987 01	50
161.746	9	universal		25
	107	Opel	11 88 303	25
161.747	107	Opel	90053225	25
	9	universal		50
	91	Mercedes	000 994 47 45	50
	91	Mercedes	126 994 12 45	50

	pag	marca	ref.adaptable	U.E.
161.747	9	universal		50
	71	Ford	6 314 544	50
	91	Mercedes	000 994 09 45	50
161.748	8	universal		50
	91	Mercedes	004 994 31 45	25
161.749	8	universal		50
	91	Mercedes	002 994 80 45	25
161.750	3	universal		25
	45	Dacia	7703 017 090	25
	106	Opel		25
	136	Renault	7703 017 090	25
161.751	50	Fiat	46790807	25
161.752	4	universal		25
	48	Fiat	46419734	25
161.753	4	universal		25
	48	Fiat	46401657	25
161.754	5	universal		25
	49	Fiat	46401658	25
161.755	175	VAG	N 103 055 02	50
161.756	9	universal		25
	107	Opel	20 72 001	25
	107	Opel	11094002	25
161.757	7	universal		50
	91	Mercedes	001 994 54 45	50
	91	Mercedes	000 994 42 45	50
161.758	4	universal		10
	48	Fiat	46421193	10
161.759	51	Fiat	14228471	50
161.760	3	universal		25
	48	Fiat		25
	116	PSA		25
161.761	3	universal		25
	116	PSA	6925.N0	25
161.762	3	universal		25
	136	Renault	7703 017 089	25
161.763	3	universal		25
	136	Renault		25
161.764	3	universal		25
	174	VAG	N 103 546 01	25
161.765	175	VAG	1J6 867 276	25
161.766	175	VAG	1J0 858 137 B	25
	175	VAG	1J0 858 137 A	25
161.767	117	PSA	7030.19	25
161.768	175	VAG	1J9 867 981	25
161.769	3	universal		25
	136	Renault	7703 017 104	25
	136	Renault	7703 017 087	25
161.770	175	VAG	1P0 864 247	50
161.771	9	universal		50
	71	Ford	1 084 756	50
	71	Ford	W706066S301	50

	pag	marca	ref.adaptable	U.E.
161.772	36	BMW	51 71 8 212 164	10
	36	BMW	07 14 6 981 767	10
	102	Mini	51 71 8 212 164	10
	102	Mini	07 14 6 981 767	10
161.773	177	VAG	8K0 805 922 A	10
	38	BMW	51 12 7 164 686	25
161.774	38	BMW	07 12 9 901 746	50
	38	BMW	07 12 9 925 770	50
	102	Mini	07 12 9 901 746	50
	102	Mini	07 12 9 925 770	50
161.775	38	BMW	51 35 7 135 518	25
161.776	38	BMW	51 71 7 012 032	25
161.777	3	universal		50
	136	Renault	7703 017 138	50
	136	Renault	7703 017 097	50
161.778	3	universal		50
	136	Renault	7703 017 011	50
	136	Renault	7703 017 108	50
161.779	45	Dacia	7703 046 143	50
	45	Dacia	7703 046 098	50
	138	Renault	7703 046 143	50
	138	Renault	7703 046 098	50
161.780	177	VAG	8K0 805 121	10
161.781	106	Opel	11 10 936	25
	106	Opel	13154960	25
161.782	177	VAG	N 907 965 02	25
161.783	38	BMW	51 41 2 756 212	50
	102	Mini	51 41 2 756 212	50
161.784	38	BMW	07 14 7 154 227	25
161.785	38	BMW	07 14 7 054 461	25
	102	Mini	07 14 7 054 461	25
161.786	38	BMW	07 14 9 241 763	25
161.787	8	universal		25
	36	BMW	51 12 3 413 810	25
161.788	8	universal		50
	36	BMW	07 12 9 904 150	50
	36	BMW	07 12 9 901 656	50
162.200	26	universal		100
162.201	26	universal		50
162.202	26	universal		100
162.211	26	universal		100
162.212	26	universal		50
162.221	25	universal		100
	113	Opel	23 46 824	100
	113	Opel	23 38 961	100
	113	Opel	90283614	100
	131	PSA	8964.57	100
	157	Renault		100
162.222	25	universal		100
	113	Opel	22 26 953	100
	113	Opel	90328384	100

	pag	marca	ref.adaptable	U.E.
162.222	131	PSA		100
	157	Renault	7703 081 185	100
162.227	64	Fiat	14188282	50
	64	Fiat	92511089	50
	64	Fiat	46306526	50
162.228	65	Fiat	7538675	50
162.229	64	Fiat	14188380	100
	128	PSA		100
	154	Renault	7703 077 059	100
162.230	76	Ford		25
	192	VAG	7M0 883 069	25
162.231	77	Ford	6 099 812	50
	77	Ford	E865063S	50
162.232	64	Fiat	7570122	50
162.234	154	Renault	7703 077 193	50
162.235	43	BMW		50
	77	Ford		50
	192	VAG	823 867 299	50
162.237	12	universal		100
	133	PSA	6987.A7	100
162.238	12	universal		100
	68	Fiat	14201980	100
	68	Fiat	17894580	100
	80	Ford	1 416 795	100
	80	Ford	114301ES	100
	96	Mercedes	638 988 02 25	100
	159	Renault	7703 081 086	100
	166	Seat	NR-14201980	100
162.240	12	universal		100
	69	Fiat	14211580	100
	166	Seat		100
162.241	13	universal		50
	166	Seat		50
162.242	11	universal		25
	69	Fiat	14202782	25
	166	Seat	NR-14202782	25
162.243	11	universal		25
	69	Fiat	14202985	25
	166	Seat	NR-14202985	25
162.244	12	universal		100
	68	Fiat	83468353	100
	68	Fiat	14115960	100
	133	PSA	6992.G2	100
162.245	198	VAG	155 809 966	100
	12	universal		25
	68	Fiat		25
162.247	58	Fiat	4241451	50
	166	Seat	NG-20502815	50
162.248	58	Fiat	7544349	50
	166	Seat		50
162.250	58	Fiat	15681000	25

	pag	marca	ref.adaptable	U.E.
162.251	58	Fiat	14341000	25
162.252	30	universal		5
	58	Fiat	5952101	5
162.253	30	universal		5
	58	Fiat	5946583	5
162.254	58	Fiat	7644689	10
162.257	74	Ford	1 500 238	25
	74	Ford	E826110S	25
	197	VAG	4D0 868 637	25
162.258	17	universal		50
	63	Fiat	5988006	50
162.259	14	universal		100
	98	Mercedes	638 984 02 61	100
	160	Renault	7703 072 144	100
162.260	21	universal		50
	63	Fiat	129421	50
162.261	82	Ford	6 040 784	25
162.262	82	Ford	6 053 937	25
162.263	62	Fiat	5998258	25
	62	Fiat	7686500	25
162.264	68	Fiat	4358789	50
162.266	74	Ford		25
	106	Opel	01 74 751	25
162.267	197	VAG	191 853 615 A	50
162.270	57	Fiat	7622907	10
162.272	57	Fiat	7569853	10
162.273	57	Fiat	4392447	10
	162	Seat		10
162.281	112	Opel	12 18 601	25
	112	Opel	90181010	25
162.282	74	Ford	6 184 715	20
	74	Ford	89FG13B128CA	20
162.292	30	universal		5
	183	VAG	191 941 133	5
162.293	30	universal		5
	183	VAG	191 941 141	5
162.294	37	BMW		50
162.295	183	VAG	191 941 142	50
	180	VAG	165 807 193 B	5
162.297	195	VAG	3A0 867 301	10
	195	VAG	191 867 301 A	10
162.298	30	universal		5
	74	Ford	6 186 660	5
162.299	74	Ford	89FG13K040EA	5
	30	universal		5
162.299	74	Ford	6 186 659	5
	74	Ford	89FG13K040DA	5
	194	VAG	1H0 868 243	25
162.301	187	VAG	1H0 853 585	10
162.302	187	VAG	1H0 853 585 B	10
162.303	187	VAG	1H0 853 585 A	10

	pag	marca	ref.adaptable	U.E.
162.305	60	Fiat	82415302	10
162.306	148	Renault	7700 838 242	10
162.307	165	Seat		10
162.316	60	Fiat	5994095	10
	60	Fiat	7775575	10
162.317	180	VAG	171 807 267	5
162.319	110	Opel	01 74 843	10
	110	Opel	90119995	10
	25	universal		100
162.320	113	Opel		50
	131	PSA		50
	157	Renault		50
162.321	26	universal		50
162.324	110	Opel		10
162.325	165	Seat	FC-55609200	25
162.326	12	universal		100
	68	Fiat	14215480	100
	68	Fiat	82468243	100
	166	Seat	NR-14215480	100
162.327	152	Renault	7703 080 048	10
	139	Renault	7703 044 121	10
162.328	139	Renault	7703 044 121	10
162.329	178	VAG		10
162.331	12	universal		50
	198	VAG	811 807 577 C	50
	198	VAG	867 809 966	50
162.332	28	universal		25
162.341	22	universal		100
	135	PSA	6973.34	100
	201	VAG		100
162.344	28	universal		25
162.345	112	Opel	12 16 904	25
	112	Opel	90123504	25
162.347	126	PSA	6992.T0	10
	126	PSA	95571660	10
162.349	126	PSA	95556738	10
162.351	59	Fiat	60528009	10
162.354	27	universal		50
	66	Fiat	60503610	50
162.356	5	universal		25
	50	Fiat	7628035	25
	162	Seat		25
162.357	5	universal		25
	50	Fiat	5940767	25
	50	Fiat	7569387	25
	162	Seat		25
162.359	50	Fiat	5967727	25
	50	Fiat	7508973	25
	162	Seat		25
162.360	163	Seat	00.05940037	25
162.362	10	universal		50

	pag	marca	ref.adaptable	U.E.	
162.362	51	Fiat		50	
	70	Ford	6 028 434	50	
	70	Ford	E642280S	50	
	106	Opel	01 64 361	50	
	106	Opel	90033713	50	
	116	PSA		50	
	137	Renault	7703 001 123	50	
	174	VAG		50	
	162.363	5	universal		25
		49	Fiat	16043324	25
162		Seat		25	
162.364	162	Seat		10	
162.368	13	universal		25	
	67	Fiat	14216080	25	
162.369	67	Fiat	14216087	25	
	67	Fiat	76778650	50	
162.370	127	PSA	9566 7895	50	
	185	VAG	5J0 853 573	50	
162.371	133	PSA	6992.87	25	
162.372	77	Ford	4 046 124	100	
	77	Ford	W705254S300	100	
	128	PSA	6992.51	100	
	128	PSA	6996.36	100	
	128	PSA	6995.A3	100	
	128	PSA	9615453880	100	
	154	Renault	7703 077 111	100	
	162.373	19	universal		100
		79	Ford	1 104 880	100
		99	Mercedes	000 990 29 92	100
115		Opel	11 04 880	100	
115		Opel	90087290	100	
162.375	135	PSA		100	
	201	VAG	161 867 299	100	
	201	VAG	N 038 549 01	100	
	71	Ford		25	
162.378	117	PSA		25	
	139	Renault	7703 044 058	25	
162.379	65	Fiat	14187880	100	
	165	Seat	NR-14187480	100	
162.381	65	Fiat	14191180	50	
	129	PSA	8336.40	50	
162.382	78	Ford	E866061SSYNB	25	
	26	universal		50	
	78	Ford	1 018 433	50	
162.383	78	Ford	W704218SSMJCP	50	
	26	universal		50	
	78	Ford	6 725 950	50	
162.384	78	Ford	E866202SSYNB3	50	
	10	universal		50	
162.385	70	Ford	1 647 309	50	
	76	Ford	6 142 786	25	

	pag	marca	ref.adaptable	U.E.
162.385	76	Ford	E864181S	25
	16	universal		100
162.389	63	Fiat	5962559	100
	134	PSA	6972.02	100
162.390	52	Fiat	7670683	10
162.391	62	Fiat	7641970	25
162.392	62	Fiat	7678808	25
162.393	50	Fiat	5979901	10
	162	Seat		10
162.394	56	Fiat		1
162.395	56	Fiat		1
162.396	56	Fiat	7590885	10
	5	universal		10
162.397	174	VAG	6N0 807 199	10
	174	VAG	N 907 407 01	10
162.398	65	Fiat	7658893	50
162.399	65	Fiat	46410400	50
	65	Fiat	60600860	50
162.400	56	Fiat	5981746	5
	164	Seat		5
	12	universal		50
162.401	166	Seat	HH-53008000	50
162.402	165	Seat		100
	56	Fiat	7608126	10
162.403	56	Fiat	60805802	10
	180	VAG	191 807 193	10
162.404	56	Fiat	82428097	1
162.405	77	Ford	7 723 510	50
	165	Seat		50
162.406	52	Fiat	7603637	5
162.407	69	Fiat	7587776	25
162.408	69	Fiat	7739802	10
162.409	74	Ford		25
	111	Opel	22 40 582	50
162.410	111	Opel	22 40 587	50
	111	Opel	90321121	50
162.411	110	Opel	01 74 846	25
162.412	112	Opel	12 17 801	25
	112	Opel	90321482	25
162.413	6	universal		25
162.414	6	universal		25
162.415	6	universal		25
162.421	192	VAG	801 867 299	50
162.423	82	Ford	1 443 038	50
	82	Ford	3014E7902358AFA	50
	16	universal		50
	63	Fiat	7556533	50
162.424	99	Mercedes	638 990 04 92	50
	134	PSA		50
	160	Renault	7703 072 220	50
	200	VAG	1M0 853 547 A	50

	pag	marca	ref.adaptable	U.E.
162.425	23	universal		25
	79	Ford		25
162.426	150	Renault	7701 030 059	25
162.427	61	Fiat	14578082	25
	163	Seat	NR-14578083	25
162.428	163	Seat		25
162.429	199	VAG	N 90206501	10
162.430	127	PSA	7437.07	100
	14	universal		100
	44	BMW		100
162.431	115	Opel		100
	134	PSA	6972.07	100
	200	VAG	113 857 117 B	100
162.435	116	PSA	7429.47	5
162.436	116	PSA	7429.48	5
162.439	51	Fiat	15624411	25
	117	PSA	96 004 002 80	25
162.440	26	universal		50
	131	PSA	6992.31	50
162.441	131	PSA	6996.45	50
	7	universal		50
	51	Fiat	60811807	50
162.442	117	PSA		50
	139	Renault	7703 046 048	50
	176	VAG		50
	7	universal		50
162.444	51	Fiat	46473571	50
	139	Renault		50
162.446	132	PSA	6995.N7	50
	132	PSA	9609212380	50
162.447	24	universal		100
	130	PSA	7903 077 167	100
162.449	166	Seat	NR-14188880	25
162.450	24	universal		50
	156	Renault		50
162.451	154	Renault	7703 077 109	25
162.452	154	Renault	7703 077 108	25
	25	universal		100
	97	Mercedes	638 984 13 61	100
162.453	131	PSA	6992.66	100
	157	Renault	7703 077 068	100
	25	universal		100
162.454	131	PSA	6995.15	100
	157	Renault	7703 077 066	100
	157	Renault	7703 077 148	100
	14	universal		50
	44	BMW	51 16 1 881 149	50
162.456	98	Mercedes	000 990 34 92	50
	134	PSA		50
	160	Renault	7703 072 116	50
	200	VAG	N10259301	50

	pag	marca	ref.adaptable	U.E.
162.457	11	universal		25
	166	Seat	NR-14203080	25
162.462	152	Renault		5
162.463	142	Renault	7703 077 300	10
	50	Fiat	14116890	50
	71	Ford		50
162.465	117	PSA		50
	139	Renault	7703 044 087	50
	139	Renault	7701 397 164	25
162.466	139	Renault	7703 044 013	25
	139	Renault	7703 044 172	25
162.468	159	Renault	7703 081 147	25
162.471	149	Renault	7703 081 161	25
162.472	142	Renault	7703 077 341	25
162.473	152	Renault	7701 408 846	25
162.474	152	Renault	7701 408 847	25
162.475	62	Fiat	7078732	25
	151	Renault	7701 408 860	25
162.477	151	Renault		10
	3	universal		25
162.478	137	Renault	7703 016 264	25
	9	universal		50
162.479	138	Renault	7703 046 049	50
	13	universal		50
162.480	80	Ford	1 659 672	25
	16	universal		50
162.481	134	PSA		50
	160	Renault	7703 072 236	50
162.483	11	universal		25
	159	Renault	7703 081 134	25
	46	Dacia	7703 079 290	25
	124	PSA		25
162.485	150	Renault	7703 079 027	25
	150	Renault	7703 079 290	25
162.488	152	Renault	7703 077 362	25
162.489	152	Renault	7703 077 363	25
162.490	3	universal		25
	137	Renault	7703 016 514	25
162.491	166	Seat	HB-93981000	25
162.492	166	Seat	NR-14199688	25
	25	universal		100
162.493	66	Fiat	14592587	100
	165	Seat	NR-14592587	100
162.494	166	Seat	NG-01746109	25
162.499	166	Seat		25
162.500	186	VAG	191 853 577	25
	127	PSA	6991.N4	50
162.501	127	PSA	6979.C6	50
	186	VAG	357 853 575	50
162.502	186	VAG	357 853 585	50
	186	VAG	357 853 586	50

	pag	marca	ref.adaptable	U.E.
162.503	192	VAG	171 807 249 A	50
162.504	184	VAG	251 823 717	50
162.505	18	universal		50
	99	Mercedes	001 994 41 45	50
	200	VAG	171 885 767	50
162.506	182	VAG	1H0 823 397	10
162.510	65	Fiat	7733801	50
162.511	69	Fiat	7745194	10
162.512	27	universal		50
	66	Fiat	1301788650	50
	66	Fiat	1301788800	50
	66	Fiat	1301019650	50
	131	PSA	8331.38	50
	131	PSA	8748.W4	50
162.514	56	Fiat	7762436	1
	56	Fiat	46427367	1
	57	Fiat	7739088	10
162.515	57	Fiat	7792009	10
162.516	57	Fiat	82457328	10
	20	universal		50
162.517	63	Fiat	82421028	50
	63	Fiat	504056662	50
	133	PSA	7903 081 055	25
162.519	15	universal		25
	63	Fiat	7569468	25
162.520	163	Seat	00.04442520	10
162.523	11	universal		50
	67	Fiat	7543023	50
	67	Fiat	7677856	50
	133	PSA	6992.80	50
	159	Renault	7703 081 019	50
162.524	52	Fiat	7781964	5
162.525	51	Fiat	7678439	25
	51	Fiat	7781538	25
162.526	5	universal		25
	49	Fiat	7635233	25
162.527	51	Fiat	7677561	25
162.528	4	universal		25
	48	Fiat	10707524	25
	48	Fiat	18770424	25
162.529	4	universal		25
	48	Fiat	7739729	25
	48	Fiat	7785196	25
162.530	65	Fiat	7603823	50
	65	Fiat	7603825	50
162.531	69	Fiat	7603825	10
	69	Fiat	7636064	10
162.532	163	Seat	00.04472197	10
162.533	58	Fiat	7656214	25
	166	Seat		25

	pag	marca	ref.adaptable	U.E.
162.534	12	universal		50
	69	Fiat	14202383	50
	166	Seat	NR-14202383	50
162.535	59	Fiat	7703577	10
162.536	56	Fiat	7699248	1
162.538	163	Seat		10
162.541	163	Seat		25
162.542	163	Seat		10
162.545	13	universal		50
	68	Fiat	14203680	50
	166	Seat	NR-14203680	50
162.547	124	PSA		25
162.548	76	Ford	1 591 426	50
162.549	132	PSA		25
162.551	165	Seat	00.04432192	50
162.553	165	Seat	NR-14187980	50
162.554	97	Mercedes	638 984 01 61	50
	165	Seat	00.92310243	50
162.555	3	universal		50
	70	Ford	2 026 706	50
	106	Opel	20 22 107	50
	106	Opel	20 26 706	50
	106	Opel	11093351	50
	174	VAG		50
	3	universal		50
162.556	36	BMW	12 13 8 530 118	50
	36	BMW	07 11 9 916 967	50
	70	Ford	1 470 997	50
	70	Ford	1 473 084	50
	70	Ford	2 022 203	50
	70	Ford	6 077 150	50
	91	Mercedes		50
	106	Opel	20 22 203	50
	174	VAG	311 821 143	50
	174	VAG	N 905 426 02	50
162.557	163	Seat		25
162.558	166	Seat	NR-14574790	25
162.559	2	universal		100
162.560	2	universal		100
162.562	198	VAG	443 853 547 B	25
162.563	163	Seat	4401310	25
162.564	162	Seat	NR-14219290	25
162.565	164	Seat		5
162.566	164	Seat		5
162.567	164	Seat		5
162.568	163	Seat	00.05978963	25
162.570	28	universal		25
162.571	163	Seat	JA-53008000	10
162.575	28	universal		25
162.579	26	universal		100
	165	Seat		100

	pag	marca	ref.adaptable	U.E.
162.580	26	universal		100
	165	Seat	00.08235646	100
162.585	6	universal		25
162.588	6	universal		25
162.589	6	universal		25
162.590	6	universal		25
162.591	7	universal		50
	138	Renault		50
162.595	149	Renault	7703 081 003	25
162.598	64	Fiat	4399987	50
	165	Seat	GA-55819410	50
162.599	165	Seat	00.04412934	25
162.600	6	universal		100
162.602	26	universal		100
162.603	26	universal		50
162.605	163	Seat		25
162.607	2	universal		50
162.608	166	Seat	00.04292588	25
162.609	12	universal		50
	166	Seat	HB-56625000	50
162.610	166	Seat	LF-89016600	25
162.611	27	universal		50
162.613	27	universal		100
162.614	26	universal		100
162.615	165	Seat	00.04461409	10
162.618	74	Ford		25
	132	PSA	8659.HQ	25
162.619	5	universal		10
	137	Renault	7703 024 015	10
162.624	15	universal		100
	63	Fiat	51754057	100
162.624	134	PSA	6973.46	100
	6	universal		25
162.625	6	universal		25
162.626	6	universal		25
162.627	6	universal		25
162.628	6	universal		25
162.629	6	universal		25
162.630	111	Opel		50
162.632	19	universal		50
	79	Ford	7 200 671	50
	201	VAG	N 0385501	50
162.633	128	PSA	6995.02	100
	128	PSA	6999.CR	100
162.634	9	universal		50
	138	Renault		50
162.635	8	universal		50
	138	Renault		50
162.640	163	Seat	00.04424781	10
162.641	163	Seat	00.04450794	10
162.643	24	universal		100
	156	Renault	7703 077 079	100



	pag	marca	ref.adaptable	U.E.
162.646	26	universal		100
	157	Renault		100
162.647	14	universal		100
	160	Renault		100
162.648	132	PSA		50
	158	Renault	7700 836 190	50
162.649	13	universal		100
	159	Renault		100
162.650	30	universal		1
	122	PSA	95634217	1
162.651	82	Ford	6 183 092	10
162.653	60	Fiat	4378829	5
162.653	164	Seat		5
162.656	27	universal		50
	131	PSA	7518.N8	50
	157	Renault	7703 077 225	50
162.657	25	universal		50
	131	PSA	6983.17	50
162.658	27	universal		50
	78	Ford	6 678 518	50
	78	Ford	W700671S300	50
162.659	192	VAG	811 863 905 A	50
162.660	25	universal		100
	66	Fiat	82412036	100
	131	PSA		100
162.661	28	universal		25
162.662	28	universal		25
162.663	28	universal		25
162.664	14	universal		25
	200	VAG	893 823 740	25
162.665	19	universal		25
	201	VAG	171 853 695 A	25
162.666	17	universal		25
	200	VAG	811 807 447	25
162.667	128	PSA	6992.82	50
162.668	154	Renault	7703 077 183	25
162.669	154	Renault	7703 077 345	25
162.670	194	VAG	1H0 868 246 A	25
162.671	194	VAG	1H0 868 244 B	25
162.672	154	Renault	7703 077 243	10
162.673	154	Renault	7703 077 192	25
162.674	195	VAG	321 867 299 B	10
162.675	132	PSA		50
	158	Renault	7701 397 195	50
162.676	132	PSA	8565.17	50
162.677	186	VAG	171 853 585	25
	186	VAG	171 853 585 A	25
162.679	62	Fiat	4294167	25
	163	Seat	FC-59018000	25
162.680	62	Fiat	7778275	25
	126	PSA		25

	pag	marca	ref.adaptable	U.E.
162.681	152	Renault	7701 043 799	10
162.682	152	Renault	7701 040 837	10
162.683	152	Renault		10
162.684	152	Renault		10
162.685	152	Renault		10
162.686	152	Renault		10
162.687	152	Renault		10
162.688	117	PSA	8742.19	10
162.689	185	VAG	191 853 733 A	100
162.690	185	VAG	1H0 853 733 B	100
162.691	62	Fiat	7613917	25
162.692	126	PSA	7420.47	10
162.694	146	Renault	7700 817 502	10
162.696	50	Fiat	7623058	10
162.697	50	Fiat	7622939	10
162.699	64	Fiat	7769778	10
162.700	149	Renault	7703 081 170	25
	149	Renault	7703 081 190	25
162.701	149	Renault	7703 081 151	25
162.702	3	universal		25
	136	Renault	7703 016 405	25
	174	VAG	N 103 091 01	25
162.704	195	VAG	811863905D01C	25
162.705	24	universal		25
	156	Renault	7703 077 080	25
162.706	26	universal		50
	66	Fiat	5961759	50
162.708	66	Fiat	7560860	50
	135	PSA	6992.18	10
162.709	178	VAG		10
	10	universal		25
162.710	137	Renault	7703 072 241	25
	3	universal		50
162.711	48	Fiat	7630815	50
	48	Fiat	15690307	50
	6	universal		25
	71	Ford		25
	107	Opel	20 64 162	25
	107	Opel	11095121	25
	117	PSA		25
	139	Renault		25
	175	VAG		25
	6	universal		25
162.712	71	Ford		25
	107	Opel	20 66 027	25
	107	Opel	11074603	25
	117	PSA		25
	139	Renault	7703 033 107	25
162.713	165	Seat	00.05938663	25
162.714	64	Fiat	14191280	50

	pag	marca	ref.adaptable	U.E.
162.714	64	Fiat	82377183	50
162.715	12	universal		50
	80	Ford	6 695 013	50
	80	Ford	W700578S300	50
162.716	199	VAG	321 813 988 A	25
162.717	12	universal		25
	159	Renault		25
162.718	13	universal		25
	69	Fiat	14222581	25
	81	Ford		25
162.720	59	Fiat	46440164	10
	59	Fiat	46461781	10
162.721	197	VAG	8N0 951 257	10
162.721	144	Renault	7700 818 973	1
162.722	145	Renault	7703 077 199	10
162.723	145	Renault	7703 079 328	10
162.724	145	Renault	7703 079 714	10
162.725	69	Fiat	60509945	25
162.727	148	Renault	7700 784 690	25
162.728	148	Renault	7700 757 267	25
162.730	93	Mercedes	201 698 01 60	10
162.731	93	Mercedes	201 698 06 60	10
162.732	93	Mercedes	201 698 02 60	10
162.733	94	Mercedes	124 988 04 78	10
162.734	94	Mercedes	007 988 71 78	10
162.735	94	Mercedes	001 988 60 81	10
162.736	94	Mercedes	001 988 48 81	10
162.737	94	Mercedes	001 988 46 81	10
162.738	96	Mercedes	001 988 29 81	10
	96	Mercedes	001 988 49 81	10
162.739	94	Mercedes	001 988 44 81	10
162.740	94	Mercedes	001 988 63 81	10
162.741	94	Mercedes	001 988 50 81	10
162.744	94	Mercedes	006 988 30 78	10
162.745	94	Mercedes	201 988 03 78	10
162.746	96	Mercedes	001 318 53 58	25
	96	Mercedes	000 988 15 81	25
162.747	94	Mercedes	001 988 51 81	10
162.748	94	Mercedes	001 988 49 81	10
162.749	94	Mercedes	001 988 47 81	10
162.751	94	Mercedes	006 988 35 78	10
162.752	94	Mercedes	001 988 45 81	10
162.753	26	universal		50
	97	Mercedes	631 984 25 61	50
162.754	30	universal		10
	122	PSA	75.5109.22	10
162.755	30	universal		1
	122	PSA	95598693	1
162.756	30	universal		1
	123	PSA	96090463	1
162.757	30	universal		1

	pag	marca	ref.adaptable	U.E.
162.757	123	PSA	96082019	1
	123	PSA	6224.79	1
162.758	30	universal		1
	123	PSA	6224.69	1
162.759	185	VAG	1H0 819 055 B	25
162.760	185	VAG	1H0 819 946 A	25
162.761	184	VAG	1H0 837 111 A	25
162.762	182	VAG	6N0 823 397 A	10
	182	VAG	6N0 823 397 C	10
162.763	181	VAG	6N0 853 826	10
162.764	181	VAG	6N0 853 825	10
162.765	21	universal		50
	185	VAG	1H0 819 055 C	50
	201	VAG	1H0 819 055 C	50
162.766	21	universal		50
	201	VAG	1H0 867 199 A	50
162.767	195	VAG	1H0 867 981	10
162.768	181	VAG	1H0 854 549	10
162.769	194	VAG	1H0 868 246 B	25
162.772	196	VAG	1H0 867 276 A	25
162.773	196	VAG	1H0 867 276 C	25
162.774	12	universal		50
	198	VAG	811 807 577 C	50
162.775	12	universal		25
	198	VAG	6N0 809 966 A	25
162.776	12	universal		25
	198	VAG	165 827 592	25
162.777	196	VAG	6N3 868 561	10
162.778	184	VAG	N9057400101C	25
162.779	196	VAG	357 867 646	50
162.780	27	universal		50
	195	VAG	191 867 199 C	50
162.781	27	universal		50
	195	VAG	1H0 867 199	50
162.782	27	universal		50
	42	BMW	51 47 1 904 317	50
	78	Ford	6 998 849	50
	78	Ford	1 079 129	50
	78	Ford	W702846S300	50
	113	Opel	22 07 713	50
113	Opel	90082231	50	
195	VAG	N 90201601	50	
162.783	198	VAG	N 905 353 01	25
162.784	194	VAG	1H0 868 243 B	25
162.785	186	VAG	357 853 585 A	25
162.786	186	VAG	357 853 586 D	25
162.787	186	VAG	191 853 585 A	25
162.788	187	VAG	3A0 853 575 A	10
162.789	187	VAG	3B0 853 575	10
162.790	187	VAG	3A0 853 575	10
162.791	187	VAG	3B0 853 576	10

	pag	marca	ref.adaptable	U.E.
162.792	187	VAG	4A0 853 825 C	10
162.793	187	VAG	4A0 853 825	10
162.794	187	VAG	4A0 853 825 A	10
162.795	187	VAG	4A0 853 825 E	10
162.796	187	VAG	4A0 853 825 D	10
162.797	124	PSA		10
162.798	124	PSA		10
	150	Renault		10
162.799	124	PSA		10
162.800	126	PSA	9563 7051	50
	126	PSA	6999.A2	50
162.801	126	PSA	9563 7053	10
162.802	126	PSA	9563 7052	10
162.803	129	PSA	6990.50	50
162.804	127	PSA	8565.35	100
162.805	127	PSA	6995.X3	50
162.806	24	universal		100
	130	PSA	6966.34	100
	130	PSA	6992.95	100
162.808	125	PSA		10
162.809	112	Opel	12 18 604	25
	112	Opel	90386374	25
162.810	77	Ford	6 176 723	50
	77	Ford	E865682S	50
162.811	13	universal		50
	81	Ford	6 078 784	50
	81	Ford	81AG13N129AA	50
162.812	18	universal		50
	73	Ford	6 114 021	50
	73	Ford	E864164S	50
	79	Ford	6 114 021	50
	79	Ford	E864164S	50
	200	VAG	1C0 867 207	50
162.813	124	PSA		25
162.814	118	PSA	6992.P3	25
162.815	24	universal		50
	66	Fiat	60506575	50
162.816	66	Fiat	5757139	50
	127	PSA	8565.34	50
	143	Renault		50
162.817	155	Renault		50
	12	universal		25
162.818	104	Nissan	SS-06-0364A	25
	198	VAG		25
162.819	190	VAG		10
162.820	15	universal		100
	115	Opel	17 19 242	50
	115	Opel	90058826	50
	160	Renault	7703 072 172	50
162.821	15	universal		100
	200	VAG	N0385011	100

	pag	marca	ref.adaptable	U.E.
162.821	200	VAG	N0385012	
162.823	24	universal		100
	156	Renault	7703 077 223	100
162.824	165	Seat		100
	111	Opel		50
162.825	153	Renault	7703 077 309	50
	126	PSA	9699 5446	10
162.826	111	Opel	44 14 667	25
	111	Opel	91169651	25
	155	Renault	7703 077 430	25
162.827	142	Renault	7705 099 009	10
162.828	142	Renault	7703 077 438	25
162.829	146	Renault	7700 416 965	10
162.830	31	universal		10
	123	PSA	6224.81	10
162.831	122	PSA	95583069	10
162.832	122	PSA	95564656	10
	122	PSA	6225.66	10
162.833	199	VAG	357 827 998	25
162.834	181	VAG	165 853 674	10
162.835	198	VAG	1H0 853 947	25
162.836	198	VAG	N 90821401	25
162.837	197	VAG	3A0 853 586	50
162.839	180	VAG	1H9 807 250	10
162.840	181	VAG	1H0 863 850	10
162.841	190	VAG	1H0 837 498	10
162.842	12	universal		100
	198	VAG	1H0 853 120	100
162.843	19	universal		25
	201	VAG	333 867 633 4FB	25
162.844	76	Ford	1 065 204	50
	76	Ford	95VW257K42AA	50
	113	Opel	01 57 979	50
162.845	113	Opel	90579619	50
	184	VAG	1H0 837 719	50
	181	VAG	1H5 863 849	25
162.846	181	VAG	867 863 849 A	25
162.847	77	Ford	1 008 068	50
	77	Ford	3 865 953	50
	77	Ford	95VWA310A46DB	50
192	VAG	7M0 867 299 K	50	
162.848	128	PSA	96 126 454	25
162.849	128	PSA	96 120 786	25
162.850	128	PSA	96 139 474	25
162.851	11	universal		25
	80	Ford	1 634 125	50
	80	Ford	E826292S	50
162.852	16	universal		50
	79	Ford	6 743 363	50
	79	Ford	1 629 549	50
79	Ford	W700615S300	50	

	pag	marca	ref.adaptable	U.E.
162.853	111	Opel	23 40 950	25
	111	Opel	90269693	25
162.854	178	VAG	701 121 565	1
162.855	128	PSA	6992.J4	50
	128	PSA	96048533	50
162.856	125	PSA	9227.23	10
162.857	125	PSA	6999.93	10
	125	PSA	6999.CW	10
162.858	124	PSA		25
162.859	124	PSA	9147.14	25
	124	PSA	7903 079 144	25
162.860	150	Renault	7701 408 876	25
162.861	150	Renault	7701 030 058	25
162.862	150	Renault	7701 030 060	25
162.863	150	Renault	7701 035 664	25
162.864	150	Renault	7701 408 875	25
162.865	150	Renault	7701 408 877	25
	150	Renault	7703 079 714	25
162.866	150	Renault		25
162.867	150	Renault	7700 801 556	10
162.868	150	Renault	7700 801 557	10
162.870	61	Fiat	14578180	25
162.871	61	Fiat	5944525	25
162.872	61	Fiat	7608012	25
162.873	61	Fiat	82377992	25
162.874	107	Opel	18 24 622	10
162.875	156	Renault	7703 081 188	25
162.876	127	PSA	8565.20	25
162.877	194	VAG	8D0 839 825 A	5
162.878	25	universal		25
	78	Ford	6 866 257	25
162.879	120	PSA	6992.V7	25
162.880	67	Fiat	9605146380	50
	132	PSA	6992.K8	50
	132	PSA	6999.A3	50
162.881	151	Renault		50
162.883	24	universal		100
	130	PSA	8326.N4	100
162.884	196	VAG	321 867 838	50
162.885	198	VAG	N 908 338 01	25
162.886	60	Fiat		10
162.887	68	Fiat	46408953	10
	68	Fiat	46748771	10
	133	PSA	6991.P2	10
162.888	11	universal		50
	67	Fiat	7622606	50
	198	VAG	1L0 867 616	50
162.889	69	Fiat	7734462	10
162.890	53	Fiat	7734476	10
162.891	67	Fiat	46403322	25
162.892	11	universal		50

	pag	marca	ref.adaptable	U.E.
162.892	67	Fiat	7754387	50
	133	PSA	8251.FC	50
162.893	56	Fiat	7771628	5
162.894	27	universal		5
	56	Fiat	7788400	5
162.895	64	Fiat	46459200	25
162.896	64	Fiat	5896153	25
	64	Fiat	46524246	25
162.897	60	Fiat	46436251	10
162.898	57	Fiat	60607024	10
	57	Fiat	504001603	10
	57	Fiat	82467481	10
162.899	57	Fiat	46425772	10
162.900	60	Fiat	7769767	10
162.901	60	Fiat	7608099	10
	125	PSA	9227.29	10
162.902	11	universal		25
	67	Fiat	46478225	50
	67	Fiat	82422490	50
	133	PSA		50
162.903	13	universal		25
	114	Opel	13 20 925	25
	114	Opel	13240067	25
162.904	175	VAG	N 902 184 01	10
	57	Fiat	7799839	10
162.906	17	universal		50
	134	PSA	1539.16	50
162.907	62	Fiat	7617036	10
	62	Fiat	4678189	10
162.908	25	universal		50
	66	Fiat	735266957	50
162.909	67	Fiat	7768047	50
162.910	26	universal		50
	78	Ford	1 018 434	50
	78	Ford	W704218SSYEDQ	50
	105	Nissan	01553-0801M	50
162.911	67	Fiat	46424310	25
162.912	151	Renault	7703 074 112	10
162.913	96	Mercedes	001 988 20 81	25
162.914	144	Renault	7703 079562	10
162.915	144	Renault	7703 079 351	10
162.916	144	Renault	7703 079 369	10
162.918	40	BMW		10
	82	Ford	6 105 034	10
	82	Ford	82GG14197D2A	10
	107	Opel	12 88 548	10
162.919	107	Opel	90230571	10
	93	Mercedes	638 984 08 61	10
162.920	184	VAG	1H0 823 717	50
162.921	42	BMW	51 71 1 958 025	50

	pag	marca	ref.adaptable	U.E.
162.921	197	VAG		50
162.922	197	VAG	N 90474001	50
162.923	197	VAG	171 201 969	50
162.924	96	Mercedes		50
	197	VAG	441 955 973 B	50
162.925	6	universal		25
162.927	19	universal		50
162.928	13	universal		25
	69	Fiat	14222380	25
	69	Fiat	83468453	25
	81	Ford		25
162.929	184	VAG	6K6 863 988	25
162.930	199	VAG	357 868 143	25
162.932	158	Renault	7703 081 103	25
162.933	11	universal		25
	159	Renault	7703 081 176	25
162.934	26	universal		100
	97	Mercedes	638 984 16 61	100
	97	Mercedes	638 984 00 61	100
	105	Nissan	SS-07-0069A	100
	131	PSA		100
	157	Renault	7703 077 153	100
162.935	157	Renault	7703 077 356	100
	25	universal		100
162.936	131	PSA	6966.40	100
162.936	124	PSA	9313.09	25
162.937	109	Opel	01 88 550	10
	109	Opel	01 88 574	10
	109	Opel	90587517	10
162.938	109	Opel	01 88 577	10
	109	Opel	9131114	10
162.939	10	universal		50
	137	Renault		50
162.940	28	universal		25
162.941	46	Dacia	7703 081 054	25
	130	PSA	9699575280	25
	130	PSA	7518.N8	25
	157	Renault	7703 081 054	25
162.942	130	PSA	7903 077 172	25
162.943	41	BMW	51 13 1 960 054	10
162.944	41	BMW	51 13 8 166 675	10
	62	Fiat	71717421	10
	110	Opel	01 72 017	10
	110	Opel	90590995	10
162.945	39	BMW	51 31 1 938 494	25
	39	BMW	51 31 8 177 850	25
162.946	193	VAG	3B0 868 243	25
162.947	83	Honda	91517 SJ4 003	25
	161	Rover	DCC 10010	25
162.948	42	BMW	16 13 1 176 747	50
	81	Ford		50

	pag	marca	ref.adaptable	U.E.
162.948	100	Mini	16 13 1 176 747	50
	114	Opel	1 80 940	50
	114	Opel	90127883	50
	197	VAG	N 90127883	50
162.949	81	Ford	6 634 877	50
	81	Ford	W700980S300	50
162.950	76	Ford	1 038 008	25
	76	Ford	W704309S300	25
162.951	76	Ford	1 031 769	25
	76	Ford	W704411S300	25
162.952	82	Ford	1 051 701	10
162.953	76	Ford	E865220S	50
	97	Mercedes	006 988 43 78	50
162.954	78	Ford	1 047 847	25
	78	Ford	W704294S300	25
162.955	13	universal		25
	80	Ford	6 150 260	25
	80	Ford	E826163S	25
162.956	81	Ford	6 185 845	25
	81	Ford	E864338S	25
162.957	16	universal		25
	79	Ford	1 007 932	25
	79	Ford	96FG16K262AA	25
162.958	21	universal		25
	79	Ford	6 181 023	25
	79	Ford	E844072S	25
162.959	27	universal		50
	78	Ford	6 786 759	50
	78	Ford	W702122S300	50
	204	VOLVO	30661329	50
162.960	78	Ford	E866061SSYNB	25
162.961	155	Renault	7703 077 354	50
162.962	153	Renault	7701 047 661	50
162.963	12	universal		50
	80	Ford	1 027 000	50
	80	Ford	W702087S300	50
162.964	62	Fiat	9620669780	10
	126	PSA	96206697	10
162.965	53	Fiat	46541864	10
162.966	68	Fiat	46558337	10
162.967	121	PSA	8565.40	50
	121	PSA	8565.63	50
	127	PSA	8565.40	50
	127	PSA	8565.63	50
	153	Renault	7701 049 270	50
162.968	27	universal		50
	113	Opel		50
162.969	180	VAG	7M0 807 181 A	5
162.970	113	Opel	11 62 488	50
	113	Opel	90355604	50
162.971	82	Ford	6 758 612	25

	pag	marca	ref.adaptable	U.E.
162.971	82	Ford	W700930S300	25
162.972	82	Ford	6 180 955	25
	82	Ford	91AG14197AFA	25
162.973	77	Ford	1 070 107	50
162.974	114	Opel	11 90 365	25
	114	Opel	90139015	25
162.975	24	universal		25
	156	Renault	7703 077 444	25
162.976	65	Fiat	46776091	50
162.977	69	Fiat	46738532	10
162.978	128	PSA	6995.S0	50
162.979	17	universal		50
	63	Fiat	9621385880	50
	134	PSA	6997.T2	50
	134	PSA	6997.83	50
162.980	129	PSA	6991.E8	50
	129	PSA	6966.39	50
162.981	128	PSA	6995.Y5	50
162.982	133	PSA	7410.E2	25
162.983	124	PSA	6991.G0	25
162.984	126	PSA	6995.87	50
162.985	13	universal		50
	133	PSA	7136.A5	50
162.986	126	PSA	8565.41	10
162.987	128	PSA	6991.F4	50
162.988	128	PSA	6991.F5	50
162.989	128	PSA	6991.F6	50
162.990	185	VAG	1M0 854 541 A	10
162.991	185	VAG	1M0 854 719 A	10
162.992	62	Fiat	500339745	50
	111	Opel		50
	153	Renault	7703 077 420	50
162.993	62	Fiat	500326896	50
	111	Opel	44 12 053	50
	111	Opel	91169650	50
	153	Renault	7703 077 422	50
162.994	111	Opel		25
	153	Renault	7703 077 421	25
162.995	153	Renault	7703 077 448	25
162.996	152	Renault		25
162.997	153	Renault		10
162.998	154	Renault		25
162.999	142	Renault	7700 838 570	10
163.000	180	VAG	6K5 807 184	2
163.001	180	VAG	6K5 807 183	2
163.002	188	VAG		1
163.003	188	VAG		1
163.004	182	VAG		1
163.005	182	VAG		1
163.006	25	universal		50
	46	Dacia	7703 077 117	50

	pag	marca	ref.adaptable	U.E.
163.006	156	Renault	7703 077 117	50
163.007	25	universal		50
	156	Renault	6001 546 909	50
163.008	27	universal		50
	46	Dacia	7703 077 435	50
	157	Renault	7703 077 435	50
163.009	26	universal		25
	66	Fiat	504010315	25
163.011	62	Fiat	500327002	10
163.012	111	Opel	23 45 957	50
	111	Opel	90321122	50
163.013	77	Ford	1 020 732	25
	77	Ford	W704402	25
163.014	20	universal		50
	99	Mercedes	123 990 02 92	50
	135	PSA	7813.24	50
	201	VAG		50
163.015	126	PSA	7813.26	10
163.016	82	Ford	6 870 622	25
	82	Ford	1 629 999	25
163.017	130	PSA	6995.V6	50
163.018	73	Ford	1 106 903	10
	73	Ford	W703475S300	10
163.019	147	Renault	7703 081 180	10
163.020	18	universal		25
	185	VAG	6K0819285 B41	25
163.021	73	Ford	4 069 906	10
	73	Ford	4 494 055	10
	73	Ford	YC15B03180AB	10
163.022	73	Ford	4 069 907	10
	73	Ford	4 494 056	10
	73	Ford	YC15B03180BB	10
163.023	73	Ford	6 781 550	25
	73	Ford	W701223S300	25
163.025	60	Fiat	60655007	10
	60	Fiat	60664928	10
163.026	189	VAG		1
163.027	188	VAG		1
163.028	188	VAG		1
163.029	188	VAG		1
163.030	189	VAG		1
163.031	189	VAG		1
163.032	120	PSA	0137.11	25
163.034	61	Fiat	9790337080	1
	124	PSA	9227.31	1
163.035	20	universal		50
	85	Honda	91512-SM4-003	10
163.036	161	Rover		10
	19	universal		10
	85	Honda	91508-SM4-003	10
	161	Rover	91508-SM4-003	10

	pag	marca	ref.adaptable	U.E.
163.037	23	universal		50
	44	BMW	07 13 0 702 966	10
	47	Daewoo	94530623	10
	85	Honda	91503-SP0-003	10
	101	Mini	07 13 0 702 966	10
	161	Rover	DYQ 100230	10
	161	Rover	DYQ 100230A	10
163.038	199	VAG	357 827 998 A	25
163.039	114	Opel	14 06 984	25
	114	Opel	90482706	25
163.042	149	Renault		25
163.043	154	Renault	7703 077 434	25
163.044	15	universal		50
	44	BMW	51 11 1 908 077	50
	99	Mercedes	000 990 54 92	50
	101	Mini	51 11 1 908 077	50
	167	Smart		50
	200	VAG	N 909 591 01	50
163.045	16	universal		50
	44	BMW	51 11 8 174 185	50
	101	Mini	51 11 8 174 185	50
163.046	16	universal		50
	44	BMW	51 11 1 944 537	50
163.047	15	universal		50
	44	BMW	51 11 1 964 186	50
	115	Opel	14 00 804	50
	115	Opel	90414659	50
163.048	16	universal		50
	115	Opel	14 00 806	50
	115	Opel	90508809	50
163.049	181	VAG	6X0 853 575	10
163.050	184	VAG	6K0 823 717	50
163.051	13	universal		25
	199	VAG	4A0 857 610	25
163.052	62	Fiat	71728806	25
	127	PSA	8565.43	25
163.053	60	Fiat	46776048	10
163.054	15	universal		50
	115	Opel	14 06 925	50
	115	Opel	9130754	50
163.055	40	BMW	51 32 1 938 884	10
163.056	14	universal		50
	39	BMW	51 71 1 928 946	50
163.057	92	Mercedes		10
	107	Opel	11 80 216	10
	107	Opel	11 80 411	10
163.058	39	BMW	51 31 8 125 892	10
163.059	43	BMW	51 41 1 973 500	50
	43	BMW	51 51 8 172 050	50
163.060	43	BMW		25
163.061	43	BMW	51 48 8 181 420	50

	pag	marca	ref.adaptable	U.E.
163.062	40	BMW	51 22 1 817 032	25
163.063	11	universal		25
	42	BMW	51 13 8 102 952	25
	96	Mercedes	638 994 08 45	25
163.064	111	Opel	23 45 959	25
	111	Opel	90457899	25
163.065	111	Opel	01 74 864	50
	111	Opel	01 74 854	50
	111	Opel	90481595	50
163.066	113	Opel	22 08 843	25
	113	Opel	90218614	25
163.067	190	VAG	171 837 199	25
163.068	16	universal		25
	44	BMW	51 48 1 884 779	25
163.069	20	universal		25
	44	BMW	51 47 1 911 992	25
	99	Mercedes	201 990 02 92	25
	101	Mini	51 47 1 911 992	25
	103	Mitsubishi	M-820141	10
	204	VOLVO	30820141	25
163.070	17	universal		25
	44	BMW	51 48 1 938 725	25
163.071	175	VAG	311 881 247	25
163.072	192	VAG	6X0 868 243 A	25
163.073	193	VAG	4D0 867 299 D	25
	193	VAG	701 867 549	25
	193	VAG	443 867 299	25
163.074	20	universal		25
	201	VAG	4D0 807 300 B	25
163.075	197	VAG	8D0 853 622	25
163.076	197	VAG	865 853 231 A	25
163.077	43	BMW	51 71 1 916 197	25
163.078	39	BMW	51 71 8 108 613	25
163.079	25	universal		25
	113	Opel	11 62 484	25
	113	Opel	90040750	25
163.081	132	PSA	6997.86	50
	151	Renault		50
163.082	46	Dacia	7701 056 846	50
	121	PSA	6991.S6	50
	129	PSA	6991.S6	50
	155	Renault	7701 056 846	50
	192	VAG	8E9 867 299	50
	204	VOLVO	30648141	50
163.083	65	Fiat		25
	129	PSA	6991.Y8	25
	155	Renault	7703 077 469	25
163.084	155	Renault	7703 077 468	25
	155	Renault	8201 112 162	25
163.084	124	PSA	9147.32	25
163.085	115	Opel	18 10 850	25

	pag	marca	ref.adaptable	U.E.
163.085	115	Opel	90379945	25
	135	PSA	6991.X7	25
163.086	24	universal		50
	130	PSA	6966.33	50
163.087	25	universal		25
	131	PSA	7584.Z8	25
163.088	22	universal		50
	46	Dacia	7703 072 360	50
	105	Nissan	01515-00QAB	50
	115	Opel	44 13 420	50
	115	Opel	91169793	50
	160	Renault	7703 072 360	50
163.089	160	Renault	054000001R	50
	193	VAG	6K0 868 243 C	25
163.090	77	Ford	1 044 806	25
	77	Ford	W704165S300	25
163.091	21	universal		50
	79	Ford	1 039 463	25
	79	Ford	W704433S300	25
	160	Renault	7701 049 271	50
	201	VAG	8E0 825 267	50
163.092	154	Renault		50
163.093	64	Fiat	14186880	50
	64	Fiat	46786189	50
163.094	64	Fiat	60660554	25
163.095	50	Fiat	82435506	10
	50	Fiat	60517025	10
163.096	50	Fiat	60584337	10
163.097	50	Fiat	60507674	10
163.098	62	Fiat	71728805	25
163.099	24	universal		25
	66	Fiat	46842097	25
163.100	95	Mercedes	001 988 80 81	10
163.101	95	Mercedes	007 988 74 78	10
163.102	95	Mercedes	007 988 73 78	10
163.103	95	Mercedes	007 988 76 78	10
	187	VAG	4D0 853 825 C	10
163.104	193	VAG	3B0 837 732	50
163.105	192	VAG	703 867 299	50
163.106	192	VAG	893 867 290	50
163.107	199	VAG	1J0 853 120	25
163.108	193	VAG	3B9 863 689	10
163.109	201	VAG	8L0 807 300	10
163.110	41	BMW	51 71 8 184 574	10
163.111	189	VAG		1
163.112	189	VAG		1
163.113	189	VAG		1
163.115	154	Renault	251 867 299	25
	192	VAG	251 867 299	25
163.116	196	VAG	6N0 867 276	50
163.117	193	VAG	8Z0 868 243	50

	pag	marca	ref.adaptable	U.E.
163.117	193	VAG	3B0 868 243	50
163.118	59	Fiat		1
163.119	59	Fiat		1
163.120	104	Nissan	01553-02923	10
163.121	170	Toyota	90189-06003	10
163.122	169	Toyota	67867-12150	10
163.123	83	Honda	91520-SR3-003	25
	161	Rover	91520-SR3-003	25
163.124	83	Honda	91515-SR3-000	10
163.125	18	universal		25
	44	BMW	51 71 8 195 811	25
163.126	147	Renault	7701 050 072	10
163.127	22	universal		50
	135	PSA	7013.J0	50
	135	PSA	8211.WV	50
163.128	18	universal		25
	44	BMW	51 21 8 205 295	25
163.129	24	universal		50
	78	Ford	1 370 597	50
	78	Ford	W704128SSYYJ6	50
	195	VAG	357 863 119	50
163.130	169	Toyota	75548-20110	10
163.131	83	Honda	91511-ST3-E00	10
	161	Rover	DCC 100190	10
163.132	83	Honda	91525-SM4-003	10
	161	Rover	91525-SM4-003	10
163.133	73	Ford	1 022 510	10
	73	Ford	6 974 009	10
	73	Ford	93BBF030A12AE	10
163.134	192	VAG	6Q0 880 385	25
163.135	82	Ford		50
	132	PSA	6990.E0	50
	132	PSA	9639570480	50
	151	Renault	7701 044 547	50
163.136	130	PSA	8748.Q5	25
163.137	146	Renault	7700 842 510	5
163.138	145	Renault	7703 077 439	10
163.139	155	Renault	7703 077 441	10
163.140	15	universal		50
	46	Dacia	7703 072 361	50
	63	Fiat	51761163	50
	115	Opel	44 14 666	50
	115	Opel	91169621	50
	160	Renault	7703 072 361	50
163.141	111	Opel	44 30 858	25
	111	Opel	44 14 720	25
	111	Opel	93161475	25
	155	Renault	7701 050 734	25
	155	Renault	5001 855 049	25
	155	Renault	7703 077 368	25
163.142	155	Renault	7701 049 008	25

	pag	marca	ref.adaptable	U.E.
163.142	155	Renault	7701 057 132	25
163.143	151	Renault		25
163.144	153	Renault	7701 050 730	25
	153	Renault	7701 048 296	
163.145	155	Renault	7701 058 820	10
163.146	149	Renault	8200 305 109	10
163.147	186	VAG	8L0 853 909	25
163.148	186	VAG	8D0 853 909 B	25
163.149	110	Opel	01 72 923	25
	110	Opel	90590944	25
163.150	114	Opel	01 71 953	50
	114	Opel	90377951	50
163.151	194	VAG	6X0867301B01C	25
163.152	192	VAG	6X0 867 300 A	50
163.153	40	BMW	51 71 1 945 568	10
163.154	192	VAG	8E0 867 276	50
163.155	104	Nissan	62318-0T001	10
163.156	104	Nissan	01553-02903	25
163.157	104	Nissan	01553-01342	10
163.158	104	Nissan	01553-05751	25
	84	Honda		25
	90	Mazda		25
163.159	113	Opel	13 20 703	25
	113	Opel	94218027	25
	169	Toyota	90467-12020	25
163.160	89	Lexus	53879-14010	10
	172	Toyota	53879-14010	10
	88	Lexus	90467-10161	25
	129	PSA	6822.LL	25
163.161	168	Suzuki	09409-10312	25
	171	Toyota	90467-10161	25
	171	Toyota	90467-09206	25
163.162	88	Lexus	90467-10162	25
	171	Toyota	90467-10162	25
163.163	23	universal		10
	47	Daewoo	94530624	10
	85	Honda	91502-SP0-003	10
163.164	23	universal		10
	85	Honda	91503-SZ3-003	10
163.165	89	Lexus	90189-06013	25
	170	Toyota	90189-06013	25
163.166	20	universal		10
	89	Lexus	90467-08185	10
	105	Nissan	01553-09611	10
	135	PSA	6822.N3	10
	173	Toyota	90467-08185	10
163.167	18	universal		10
	89	Lexus	90467-07166	10
	135	PSA	6822.NK	10
	173	Toyota	90467-07166	10
163.168	16	universal		10

	pag	marca	ref.adaptable	U.E.
163.168	85	Honda	90687-SB0-003	10
	17	universal		10
	20	universal		10
163.169	85	Honda	90688-SB0-003	10
	85	Honda	90688-SB0-013	10
	161	Rover	DCC 100190	10
163.170	85	Honda	91508-SR3-000	10
163.171	20	universal		10
	79	Ford	1 429 935	10
	79	Ford	W711712S300	10
	85	Honda	91501-S04-003	10
163.172	12	universal		25
	84	Honda	75522-611-000	25
	84	Honda	75522-611-003	25
	90	Mazda	9991-00-412	25
163.173	24	universal		25
	84	Honda	90666890030	25
163.174	25	universal		25
	84	Honda	91606-SE3-003	25
163.175	182	VAG	357 823 397	10
	182	VAG	6K0 823 397	10
163.176	124	PSA	9227.51	25
	190	VAG	6N0 839 511	25
163.177	196	VAG	6K0 867 838 A	25
163.178	199	VAG	N 105 168 01	50
163.179	132	PSA	8710.67	50
	132	PSA	8710.84	50
163.180	13	universal		10
	74	Ford	6 156 396	10
	74	Ford	87BG13N129AA	10
	80	Ford	6 156 396	10
	80	Ford	87BG13N129AA	10
163.181	12	universal		50
	198	VAG	811 807 577 B	50
163.182	151	Renault		50
163.183	184	VAG	867 971 928	10
163.184	186	VAG	6K0 853 578	5
163.185	186	VAG	6K0 853 578 A	5
163.186	186	VAG	6K0 853 578 B	5
163.187	181	VAG	6K0 853 129	25
163.188	197	VAG	8L4 831 720	25
163.189	181	VAG	1J0 863 119	25
163.190	184	VAG	893 803 593	25
163.191	84	Honda	91530-ST5-003	25
163.192	13	universal		25
	84	Honda	90656-671-631	25
163.193	88	Lexus	90467-08124	25
	172	Toyota	90467-08124	25
163.194	172	Toyota	90467-10000	25
163.198	15	universal		25
	99	Mercedes	000 990 45 29	25

	pag	marca	ref.adaptable	U.E.
163.198	115	Opel	11 44 811	25
	115	Opel	90328832	25
	115	Opel	94031590	25
	204	VOLVO	1268176	25
163.199	202	VOLVO	9190981	10
163.200	120	PSA	0137.23	10
	120	PSA	0137.68	10
163.201	26	universal		50
	131	PSA	8964.77	50
163.202	146	Renault	8200 138 448	10
163.203	146	Renault	8200 138 447	10
163.204	196	VAG	1M0 867 276	25
163.205	196	VAG	1J0 867 276 B	25
163.206	17	universal		50
	184	VAG	8L3 837 199 B	50
163.207	196	VAG	1J0 867 646	25
163.208	184	VAG	8D0 803 583 L	25
163.209	195	VAG	357 867 300 A	25
163.210	16	universal		50
	200	VAG	1H0 819 145 B41	50
163.211	12	universal		50
	199	VAG	175 867 949	50
	193	VAG	8P0 868 243	25
163.212	193	VAG	8P0 868 243	25
163.213	192	VAG	7H0 843 658 A	25
163.214	146	Renault	7703 044 097	25
163.215	146	Renault	7703 044 101	25
163.216	27	universal		25
	66	Fiat	14565987	25
163.217	24	universal		25
163.218	68	Fiat	51723187	10
163.219	11	universal		25
163.220	57	Fiat	51704854	10
163.221	65	Fiat	46829200	25
163.222	11	universal		25
	46	Dacia	7703 081 185	25
	67	Fiat	500389689	25
	114	Opel	45 01 607	25
	114	Opel	9161907	25
	133	PSA	6997.96	25
163.223	145	Renault	7703 079 870	10
163.224	145	Renault	7703 179 010	10
163.225	151	Renault	8201 033 717	50
	204	VOLVO	1285015	50
163.226	160	Renault		25
163.227	177	VAG	4A0 805 121 A	25
163.228	177	VAG	4A0 805 163	25
163.229	177	VAG	N 105 791 01	25
163.230	76	Ford		25

	pag	marca	ref.adaptable	U.E.
163.230	195	VAG	7M0 868 563	25
163.231	82	Ford		25
	184	VAG	7M0 853 585 E	25
163.232	184	VAG	8E5 853 213	25
163.233	82	Ford	6 068 981	10
163.234	129	PSA	6991.T3	50
163.235	16	universal		25
	99	Mercedes	124 990 04 92	25
	115	Opel		25
	200	VAG		25
163.236	182	VAG	6Q0 998 226	1
163.237	182	VAG	6Q0 998 225	1
163.238	182	VAG	6X0 998 226	1
163.239	182	VAG	6X0 998 225	1
163.240	182	VAG	8E0 998 122	1
163.241	182	VAG	8E0 998 121	1
163.242	182	VAG	8L0 998 121	1
163.243	189	VAG		1
163.244	194	VAG	6K0 868 243	25
163.245	194	VAG	6K0 868 243 A	25
163.246	169	Toyota	53145-42010	5
163.247	170	Toyota	75494-42010	10
163.248	53	Fiat		10
	168	Suzuki	77553-65D10	10
	168	Suzuki	77553-65D00	10
	170	Toyota	90467-11063	10
163.249	18	universal		10
	89	Lexus	53879-60010	10
163.250	173	Toyota	53879-60010	10
	88	Lexus	67771-12050	25
	168	Suzuki	09409-08320-000	25
163.251	171	Toyota	67771-12050	25
	88	Lexus	75819-12040	10
163.252	172	Toyota	90467-10091	25
163.253	171	Toyota	67771-16170	25
163.254	170	Toyota	90467-10023	25
163.255	170	Toyota	90189-06005	25
163.256	13	universal		25
	170	Toyota	90189-06006	25
163.257	172	Toyota	90467-0900401	10
163.258	88	Lexus	90467-09050	10
	130	PSA	6822.N5	10
163.259	172	Toyota	90467-09050	10
	88	Lexus	90467-08011	25
163.260	172	Toyota	90467-08011	25
	172	Toyota	90467-08030	25
163.261	16	universal		50
	172	Toyota	90467-0906901	25
163.262	172	Toyota	90467-0616101	25
163.263	47	Dahiatu	90044-67395-000	10

	pag	marca	ref.adaptable	U.E.
163.264	47	Dahiatu	90044-67376-000	10
163.265	47	Dahiatu	90044-68025-000	10
163.266	87	Hyundai	87770-28000	10
163.267	103	Mitsubishi	MB-115492	10
163.268	103	Mitsubishi	MU-480033	10
	104	Nissan	01281-00231	10
163.269	18	universal		10
	103	Mitsubishi	MB-253964	10
163.270	15	universal		10
	103	Mitsubishi	MR-215510	10
163.271	15	universal		10
	103	Mitsubishi	MR-288150	10
163.272	103	Mitsubishi	MB-344789	10
163.273	103	Mitsubishi	MB-313984	10
163.274	13	universal		50
	103	Mitsubishi	M-293328	50
163.275	12	universal		50
	90	Mazda	9991-00-501	50
163.276	23	universal		10
	105	Nissan	01553-09241	10
	167	Subaru	57728AC090	10
163.277	20	universal		10
	85	Honda	91545-SE0-003	10
	105	Nissan	63848-01G00	10
	204	VOLVO	3541113	10
163.278	21	universal		10
	105	Nissan	63854-01A00	10
163.279	104	Nissan	26399-3J110	10
163.280	105	Nissan	01553-00051	10
163.281	12	universal		25
	84	Honda	90672-671-811	25
	87	Hyundai	97519-22000	25
163.282	97	Mercedes	003 988 41 78	50
163.283	96	Mercedes	000 988 52 25	25
163.284	96	Mercedes	001 988 76 81	25
163.285	95	Mercedes	001 988 31 81	10
163.286	94	Mercedes	006 988 72 78	10
163.287	96	Mercedes	201 990 00 50	50
163.288	42	BMW	16 13 1 176 747	50
	96	Mercedes	003 990 02 51	50
163.289	100	Mini	16 13 1 176 747	50
163.289	41	BMW	51 13 2 251 394	10
163.290	40	BMW	51 13 1 960 127	50
163.291	44	BMW	51 13 1 885 399	50
163.292	41	BMW	51 13 1 875 898	10
163.293	47	Daewoo	94530542	25
163.294	84	Honda	90664-671-003	10
163.295	15	universal		25
	173	Toyota	90467-06198	25
163.296	22	universal		10
	89	Lexus	90467-09093	10

	pag	marca	ref.adaptable	U.E.
163.296	173	Toyota	90467-09093	10
	23	universal		10
163.297	89	Lexus	90467-09189	10
	173	Toyota	90467-09189	10
163.298	11	universal		25
	80	Ford	6 195 721	50
	80	Ford	W700078S300	50
163.299	14	universal		50
	63	Fiat	500358569	50
	134	PSA		50
163.300	17	universal		10
	103	Mitsubishi	MB-476821	10
	167	Subaru		10
	168	Suzuki	09409-07308-5PK	10
	173	Toyota	90467-07041	10
	204	VOLVO	987789	10
163.301	17	universal		10
	168	Suzuki	09409-07325-5PK	10
163.302	18	universal		10
	168	Suzuki	09409-07303-5ES	10
163.303	14	universal		50
	63	Fiat	9621837480	50
	134	PSA	8748.C2	50
163.304	19	universal		25
	204	VOLVO	9133417	25
163.305	14	universal		50
	98	Mercedes	000 990 55 92	50
	115	Opel	23 17 703	50
	115	Opel	90116376	50
	200	VAG	N 102 195 01	50
	200	VAG	N 102 195 02	
	204	VOLVO	3923475	50
163.306	21	universal		50
	79	Ford	1 324 866	50
	79	Ford	W709987S300	50
	160	Renault	7703 072 502	50
	201	VAG	N 902 293 01	50
163.307	19	universal		100
	47	Daewoo	94530507	100
	115	Opel	17 19 245	100
	115	Opel	90138810	100
163.308	24	universal		100
	130	PSA	6992.C6	100
163.309	127	PSA	8565.48	50
	127	PSA	8565.60	50
163.310	142	Renault	7700 789 274	10
163.311	189	VAG		1
163.312	121	PSA	8123.88	25
163.313	121	PSA	8123.89	25
163.314	121	PSA	8123.90	25
163.315	121	PSA	8123.91	25

	pag	marca	ref.adaptable	U.E.
163.316	121	PSA	8123.70	10
	121	PSA	96 060 797	10
163.317	24	universal		50
	130	PSA	7437.10	50
163.318	124	PSA	9147.04	50
	150	Renault		50
163.319	177	VAG	4A0 805 121 C	25
163.320	46	Dacia	7703 081 056	50
	158	Renault	7703 081 056	50
163.321	142	Renault		10
163.322	124	PSA	9147.21	25
163.323	118	PSA	6993.A1	25
163.324	158	Renault		25
163.325	151	Renault		50
163.326	130	PSA	6547.20	25
163.327	24	universal		25
	156	Renault	7703 077 453	25
163.328	17	universal		25
	160	Renault	7703 072 352	25
163.329	14	universal		50
	105	Nissan		50
	200	VAG	1L0 853 934	50
163.330	122	PSA	6212.58	5
163.331	122	PSA	6212.57	5
163.332	111	Opel	01 22 920	50
	111	Opel	9114743	50
163.333	161	Rover	DCE 10038L	25
163.334	202	VOLVO	30678009	10
	202	VOLVO	9.484.524	10
163.335	202	VOLVO	30800957	10
163.336	202	VOLVO	30800958	10
163.337	202	VOLVO	30873201	25
163.338	142	Renault	7703 077 428	10
	142	Renault	7700 351 266	10
163.339	167	Smart	1781V002000000	10
163.340	147	Renault	7700 834 203	10
163.341	147	Renault	7700 834 202	10
163.342	147	Renault	7700 838 610	10
163.343	147	Renault	7700 838 609	10
163.344	20	universal		50
	135	PSA	8565.53	50
163.345	109	Opel	01 88 581	10
	109	Opel	90580920	10
163.346	184	VAG	6L0 839 720 A	50
163.347	39	BMW	51 13 7 145 109	25
163.348	39	BMW	51 13 7 172 103	10
163.349	39	BMW	51 13 7 145 110	10
	11	universal		50
163.350	42	BMW	07 14 6 969 296	50
	198	VAG	N 910 444 01	50
163.351	80	Ford	1 019 377	25

	pag	marca	ref.adaptable	U.E.
163.351	80	Ford	W704408S300	25
163.352	169	Toyota	52535-52012	1
163.353	169	Toyota	52536-52012	1
163.354	171	Toyota	90467-10192	25
163.355	172	Toyota	67867-52010	10
163.356	88	Lexus	90467-05096	25
	171	Toyota	90467-05096	25
163.357	172	Toyota	90467-08081	10
	23	universal		10
	89	Lexus	52161-16010	10
	135	PSA	7427.39	10
	173	Toyota	52161-16010	10
163.359	88	Lexus	56115-30100	10
	169	Toyota	56115-30100	10
163.360	202	VOLVO	1325285	10
163.361	177	VAG	4A0 805 137 A	50
163.362	149	Renault	7703 081 224	50
163.363	158	Renault	7703 081 155	25
163.364	142	Renault	8200 320 884	10
163.365	40	BMW	51 71 1 932 996	50
163.366	145	Renault	7705 002 130	10
	13	universal		25
163.367	80	Ford	6 549 354	25
	80	Ford	90BG17K657AA	25
163.368	81	Ford	1 060 318	25
	81	Ford	W703069S300	25
163.369	18	universal		50
	79	Ford	1 088 761	50
	79	Ford	W706182S300	50
	90	Mazda	9X706182X0	50
163.370	75	Ford		1
163.371	75	Ford		1
163.372	175	VAG	N 906 261 01	10
163.373	121	PSA	8110.24	10
	127	PSA	8110.24	10
163.374	126	PSA	8565.55	10
163.375	117	PSA	7030.17	50
163.376	132	PSA	6992.S2	50
163.377	13	universal		50
	133	PSA	6991.39	50
163.378	129	PSA	8742.G2	10
	155	Renault		10
163.379	121	PSA	8123.96	10
	121	PSA	7473.FL	10
	127	PSA	8123.96	10
	127	PSA	7473.FL	10
	143	Renault		10
	155	Renault		10
163.380	125	PSA	9159.A5	10
	148	Renault		10
163.381	154	Renault	8200 302 291	10



	pag	marca	ref.adaptable	U.E.
163.382	154	Renault	7703 077 457	25
163.383	146	Renault	7700 412 158	10
163.384	21	universal		10
	160	Renault	7703 072 345	10
163.385	24	universal		25
	105	Nissan		25
	113	Opel		25
	156	Renault	7703 077 471	25
163.386	24	universal		100
	130	PSA	7588.VX	100
163.387	193	VAG	8P0 868 243 A	25
163.388	198	VAG	N 105 073 01	50
163.389	17	universal		25
	200	VAG		25
	204	VOLVO	3545549	25
163.390	22	universal		50
	201	VAG	701 867 299 01C	50
163.391	22	universal		50
	201	VAG	701 867 299 U71	50
163.392	17	universal		25
	200	VAG		25
163.393	199	VAG	N 10621301	25
163.394	40	BMW		50
	62	Fiat		50
	187	VAG	1H0 853 586	50
163.395	187	VAG	7L0 839 069	10
163.396	193	VAG	8E0 837 485 C	25
163.397	65	Fiat		25
163.398	69	Fiat	51779614	25
163.399	65	Fiat	46835626	25
	65	Fiat	71738386	25
163.400	59	Fiat		1
163.401	59	Fiat		1
163.402	59	Fiat		1
163.403	59	Fiat		1
163.404	126	PSA	7840.L7	25
163.405	92	Mercedes	601 078 20 41	10
163.406	92	Mercedes	000 997 13 86	50
163.407	97	Mercedes	463 988 02 78	25
163.408	97	Mercedes	000 991 27 71	25
163.409	21	universal		50
	99	Mercedes	000 991 39 40	50
163.410	96	Mercedes	000 988 44 25	25
163.411	95	Mercedes	001 988 36 81	10
163.412	94	Mercedes	124 990 00 52	10
163.413	95	Mercedes	002 994 64 45	10
163.414	95	Mercedes	002 994 65 45	10
163.415	95	Mercedes	002 994 44 45	10
163.416	95	Mercedes	001 988 57 81	10
163.417	96	Mercedes	202 988 04 81	25
163.418	96	Mercedes	001 988 77 81	25

	pag	marca	ref.adaptable	U.E.
163.419	96	Mercedes	001 988 27 81	25
163.420	95	Mercedes	001 988 32 81	10
163.421	95	Mercedes	002 994 75 45	10
163.422	95	Mercedes	140 698 01 60	10
163.423	95	Mercedes	002 997 02 86	10
163.424	97	Mercedes	000 997 06 02	25
163.425	53	Fiat	504085696	10
	109	Opel	45 00 292	10
	109	Opel	44 15 522	10
	109	Opel	93181418	10
163.426	142	Renault	8200 333 033	10
	12	universal		50
163.427	12	universal		50
	159	Renault	7703 081 160	50
163.428	12	universal		50
	158	Renault		25
163.429	158	Renault	7703 081 222	25
	197	VAG	8D0 807 192	25
163.430	110	Opel	01 72 018	25
	110	Opel	90590996	25
163.431	109	Opel	51 04 988	50
	109	Opel	13155024	50
163.432	110	Opel	01 71 964	25
	110	Opel	90508326	25
163.433	110	Opel	01 71 965	25
	110	Opel	90508327	25
163.434	111	Opel	01 72 985	25
	111	Opel	9177065	25
163.435	110	Opel	22 28 838	25
	110	Opel	9133594	25
163.436	113	Opel	01 57 905	50
	113	Opel	90562273	50
163.437	114	Opel	01 80 942	50
	114	Opel	90413589	50
163.438	114	Opel	01 71 953	50
	114	Opel	90377951	50
	13	universal		50
	80	Ford	1 335 795	50
163.439	80	Ford	W709859S300	50
	114	Opel	12 16 957	50
	114	Opel	90230960	50
163.440	74	Ford	1 251 866	25
	74	Ford	W709688S300	25
163.441	77	Ford	1 257 376	10
	77	Ford	W709004S300	10
163.442	17	universal		50
	79	Ford	4 605 824	25
163.443	79	Ford	W709176S300	25
	81	Ford	6 084 040	25
163.444	81	Ford	E826222S	25
	153	Renault		25

	pag	marca	ref.adaptable	U.E.
163.445	153	Renault		25
163.446	153	Renault	7701 061 797	25
163.447	156	Renault		50
163.448	21	universal		25
	160	Renault		25
163.449	160	Renault		25
163.450	151	Renault		50
163.451	151	Renault		50
163.452	149	Renault	7703 081 212	10
163.453	65	Fiat		50
	129	PSA		50
163.454	42	BMW	51 16 1 943 122	50
	100	Mini	51 16 1 943 122	50
163.455	42	BMW	51 71 1 958 025	50
163.456	39	BMW	51 31 7 064 098	25
163.457	41	BMW	07 14 7 122 912	25
163.458	41	BMW	07 14 7 122 913	25
163.459	41	BMW	51 77 7 170 955	25
163.460	40	BMW	51 14 1 807 495	50
163.461	93	Mercedes	210 690 02 13	10
163.462	93	Mercedes	211 988 00 81	10
163.463	93	Mercedes	012 988 60 78	10
163.464	93	Mercedes	008 988 73 78	25
163.465	43	BMW	51 41 2 155 030	25
163.466	44	BMW	51 11 1 942 789	25
163.467	44	BMW	51 77 7 171 004	25
	44	BMW	51 71 7 002 953	25
163.468	193	VAG	8E0 868 243	25
163.469	193	VAG	5X0 867 299	25
163.470	193	VAG	7L6 868 243	25
	204	VOLVO	8679426	25
163.471	145	Renault	7703 179 088	10
163.472	90	Mazda	GA2K-68-AB1	10
163.473	90	Mazda	GA7B-50-797A	10
163.474	22	universal		10
	90	Mazda	B455-56-143	10
163.475	17	universal		10
	168	Suzuki	09409-07305-5PK	10
163.476	18	universal		10
	63	Fiat	71741883	10
	85	Honda		10
	89	Lexus	90467-07164	10
	168	Suzuki	09409-07332-000	10
173	Toyota	90467-07164	10	
163.477	167	Subaru	91017AA010	10
163.478	167	Subaru	91017FA080	10
163.479	167	Subaru	91017FA010	10
163.480	104	Nissan	01552-00661	25
163.481	105	Nissan	01553-01A50	25
163.482	20	universal		10
	85	Honda	91545-SE0-003	10

	pag	marca	ref.adaptable	U.E.
163.482	103	Mitsubishi	MR-328954	10
	105	Nissan	01553-09321	10
163.483	105	Nissan	01553-08101	10
163.484	13	universal		50
	104	Nissan	62698-V7000	50
	104	Nissan	67898-U7400	50
163.485	15	universal		50
	134	PSA	6555.LE	50
	200	VAG	7L6 868 307	50
	200	VAG	8Z0 857 784	
163.486	16	universal		50
	134	PSA		50
	160	Renault	7703 072 327	50
163.487	15	universal		50
	99	Mercedes	638 990 15 92	50
	134	PSA		50
	160	Renault	7703 072 261	50
163.488	46	Dacia		50
163.489	25	universal		50
	46	Dacia	6001 546 909	50
163.490	25	universal		50
	46	Dacia		50
163.491	46	Dacia	6001 549 265	50
163.492	60	Fiat	4373915	10
	60	Fiat	46796761	10
163.493	67	Fiat	4343799	25
	132	PSA		25
163.494	27	universal		50
	66	Fiat	14593487	50
163.495	57	Fiat	46804433	25
	120	PSA	7979.H8	25
163.496	67	Fiat	7689821	25
	67	Fiat	82406852	25
163.497	66	Fiat	735293986	50
163.498	12	universal		50
	68	Fiat	46777315	50
163.499	64	Fiat	51708640	25
163.500	61	Fiat	46474945	1
163.501	129	PSA	8565.46	50
163.502	11	universal		25
	133	PSA	7568.NZ	50
	159	Renault	7703 081 164	50
163.503	19	universal		10
	86	Hyundai	86590-28000	10
	90	Mazda	9926-50-625	10
	173	Toyota	90467-06017	10
163.504	153	Renault	8200 389 607	10
163.505	13	universal		25
	74	Ford	6 659 902	25
	74	Ford	W700895S300	25
163.506	2	universal		100

	pag	marca	ref.adaptable	U.E.
163.507	90	Mazda	HA01-50-609	10
	90	Mazda	HA01-50-609A	10
163.508	74	Ford	1 324 270	5
	74	Ford	4M5113N060AA	5
163.509	168	Suzuki		25
163.510	168	Suzuki		25
163.512	168	Suzuki		25
163.513	168	Suzuki		25
163.514	168	Suzuki		25
163.515	83	Honda	91560-S9A-A51	10
163.516	83	Honda	38993-634-810	10
163.517	83	Honda	91560-S9A-A01	10
163.518	83	Honda	91560-S6A-003	10
163.519	13	universal		25
	84	Honda	90662-SB2-003	25
163.520	84	Honda	90661-SC7-003	10
	90	Mazda	H001-50-841	10
	104	Nissan	01651-00481	10
	170	Toyota	90189-06042	10
163.521	90	Mazda	9926-40-426	50
163.522	90	Mazda	9926-40-543A	50
163.523	172	Toyota	52155-21020	2
163.524	172	Toyota	52155-21010	2
163.525	172	Toyota	52155-44010	2
163.526	89	Lexus	75397-48030	10
	170	Toyota	75397-48030	10
163.527	89	Lexus	75395-33030	10
	170	Toyota	75395-33030	10
163.528	89	Lexus	62955-12010	10
	171	Toyota	62955-12010	10
163.529	18	universal		10
	89	Lexus	90467-07201	10
	135	PSA	6822.N2	10
	173	Toyota	90467-07201	10
163.530	18	universal		10
	89	Lexus	90467-07183	10
	173	Toyota	90467-07183	10
163.531	90	Mazda	9927-40-825	10
	168	Suzuki	89422-64920	10
	171	Toyota	67771-12010	10
163.532	171	Toyota	67771-01010	10
	171	Toyota	67921-95501	10
163.533	171	Toyota	67771-22010	10
163.534	171	Toyota	75493-60020	10
163.535	171	Toyota	90467-09084-01	25
163.536	172	Toyota	90467-07175	25
163.537	93	Mercedes	638 984 09 61	10
163.538	13	universal		50
	103	Mitsubishi	MS-480002	50
163.539	103	Mitsubishi	MB-138567	10
163.540	177	VAG	4F0 805 121	25

	pag	marca	ref.adaptable	U.E.
163.541	193	VAG	6Q0 868 243	25
	193	VAG	6Q0 868 241	25
163.542	195	VAG	N 908 131 01	25
163.543	181	VAG	8E0 863 727 A	25
163.544	175	VAG	N 904 792 01	10
163.545	185	VAG	6L6 853 575 A	25
	185	VAG	6L6 853 575	25
	192	VAG	6L6 853 575 A	25
	192	VAG	6L6 853 575	25
163.546	190	VAG		1
163.547	190	VAG		1
163.548	86	Hyundai		1
163.549	86	Hyundai		1
163.550	92	Mercedes		1
163.551	92	Mercedes		1
163.552	61	Fiat		1
163.553	61	Fiat		1
163.554	40	BMW		1
163.555	40	BMW		1
163.556	40	BMW		1
163.557	40	BMW		1
163.558	40	BMW		1
163.559	112	Opel		1
163.560	112	Opel		1
163.561	112	Opel		10
163.562	112	Opel		1
163.563	112	Opel		1
163.564	75	Ford		1
	190	VAG		1
163.565	75	Ford		1
	190	VAG		1
163.566	75	Ford		1
163.567	75	Ford		1
163.568	75	Ford		1
163.569	75	Ford		1
163.570	75	Ford		1
163.571	75	Ford		1
163.572	75	Ford		1
163.573	75	Ford		1
163.574	148	Renault		1
163.575	148	Renault		1
163.576	148	Renault		1
163.577	148	Renault		1
163.578	148	Renault		1
163.579	148	Renault		1
163.580	148	Renault		1
163.581	148	Renault		1
163.582	125	PSA		1
	149	Renault		1
163.583	125	PSA		1
	149	Renault		1

	pag	marca	ref.adaptable	U.E.
163.584	149	Renault		1
163.585	149	Renault		1
163.586	125	PSA		1
	149	Renault		1
163.587	125	PSA		1
	149	Renault		1
163.588	125	PSA		1
163.589	125	PSA		1
163.590	125	PSA		1
163.591	125	PSA		1
163.592	125	PSA		1
163.593	125	PSA		1
163.594	77	Ford	4 860 409	25
	77	Ford	W713489S300	25
	121	PSA	9341.PF	25
	129	PSA	9341.PF	25
163.595	143	Renault	7701 057 073	25
	155	Renault	7701 057 073	25
163.596	125	PSA		1
163.597	125	PSA		1
163.598	190	VAG		1
163.599	190	VAG		1
163.600	190	VAG		1
163.601	190	VAG		1
163.602	188	VAG		1
163.603	188	VAG		1
163.604	188	VAG		1
163.605	188	VAG		1
163.606	59	Fiat		1
163.607	59	Fiat		1
163.608	65	Fiat	71747674	25
163.609	60	Fiat	7798609	10
163.610	17	universal		25
	63	Fiat	51756677	25
163.611	12	universal		25
	68	Fiat	500380712	25
163.612	62	Fiat	5041017	25
163.613	73	Ford	6 781 549	10
	73	Ford	W701221S300	10
163.614	111	Opel	01 49 910	50
	111	Opel	90560163	50
163.615	104	Nissan	65846-30F00	10
163.616	168	Suzuki	09409-08322-000	25
163.617	168	Suzuki	09409-10309-000	10
163.618	84	Honda	90672-671-003	10
	84	Honda	90674-SK3-E00	10
163.619	90	Mazda		25
	170	Toyota	90189-06010	25
163.620	171	Toyota	67771-30070	10
163.621	88	Lexus	90467-10167	10
	171	Toyota	90467-10167	10

	pag	marca	ref.adaptable	U.E.
163.622	13	universal		25
	170	Toyota	90189-06226	25
163.623	100	Mini	07 13 1 480 418	25
163.624	101	Mini	07 13 7 036 160	25
163.625	101	Mini	51 13 7 034 022	10
163.626	100	Mini	07 13 7 036 159	10
163.627	100	Mini	07 13 7 073 915	25
163.628	100	Mini	07 13 1 480 419	25
163.629	101	Mini	51 71 1 496 621	50
163.630	25	universal		50
	131	PSA	6992.78	50
163.631	122	PSA	6545.86	25
163.632	132	PSA	8565.47	25
163.633	122	PSA	6347.47	25
163.634	132	PSA	6995.N3	10
163.635	133	PSA	6995.N4	10
163.636	101	Mini	51 13 7 127 001	25
163.637	185	VAG	1P0 854 719 B	50
163.638	126	PSA	7840.L6	25
163.639	161	Rover	DYC 500020	25
163.640	17	universal		25
	93	Mercedes	123 990 05 92	25
	93	Mercedes	126 990 03 92	25
	99	Mercedes	123 990 05 92	25
163.641	99	Mercedes	126 990 03 92	25
	73	Ford	3 680 267	10
163.642	73	Ford	98AB030A12AB	10
	109	Opel	01 88 580	10
163.643	109	Opel	9131181	10
	103	Mitsubishi	MR-447362	10
163.644	203	VOLVO	30874958	10
	203	VOLVO	30864984	25
163.645	121	PSA	8123.68	10
163.646	203	VOLVO	30870550	10
163.647	203	VOLVO	30872551	25
163.648	193	VAG	3C0 867 333	25
163.649	103	Mitsubishi	M-283083	50
163.650	88	Lexus	75545-53010	10
	169	Toyota	75545-53010	10
163.651	100	Mini	07 13 1 490 537	25
163.652	100	Mini	51 31 7 046 633	25
163.653	100	Mini	51 31 7 111 933	25
163.654	40	BMW		1
163.655	40	BMW		1
163.656	161	Rover		1
163.657	161	Rover		1
163.658	161	Rover		1
163.659	92	Mercedes		1
163.660	125	PSA		1
	148	Renault		1
163.661	125	PSA		1

	pag	marca	ref.adaptable	U.E.
163.661	148	Renault		1
163.662	125	PSA		1
163.663	125	PSA		1
163.664	190	VAG		1
163.665	144	Renault	7701 056 972	5
163.666	45	Dacia		1
163.667	45	Dacia		1
163.668	146	Renault	8200 012 580	1
163.669	129	PSA	9345.ZN	25
	155	Renault	7703 077 476	25
163.670	143	Renault	7701 056 146	10
163.671	143	Renault	7701 053 507	25
163.672	121	PSA	8123.98	10
163.673	143	Renault	7701 062 542	10
	143	Renault	7701 070 377	10
163.674	143	Renault	8200 335 703	10
163.675	110	Opel	01 74 836	10
	110	Opel	90588746	10
163.676	110	Opel	01 74 845	10
	110	Opel	90588747	10
163.677	114	Opel	08 17 950	50
	114	Opel	90287467	50
163.678	24	universal		50
	113	Opel	09 12 466	50
163.679	113	Opel	90335715	50
	111	Opel	01 22 915	50
163.680	111	Opel	90589557	50
	111	Opel	01 49 907	50
163.681	111	Opel	90414663	50
	77	Ford	1 214 485	50
163.682	77	Ford	W709011S300	50
	77	Ford	1 208 973	50
163.683	77	Ford	1 552 662	50
	77	Ford	W709010S300	50
163.684	76	Ford	1 020 193	25
	76	Ford	6 877 869	25
163.685	76	Ford	W704258S300	25
	82	Ford	1 042 065	25
163.686	82	Ford	W702985S300	25
	76	Ford	1 360 385	25
163.687	76	Ford	3M51-28774-BB	25
	76	Ford	1 424 916	25
163.688	76	Ford	W711022S300	25
	193	VAG	3B0 839 723	25
163.689	87	Hyundai	86848-22000	50
163.690	13	universal		25
	87	Hyundai	85744-28000	25
163.691	87	Hyundai	87756-1C000	25
163.692	87	Hyundai	87756-35000	25
163.693	87	Hyundai	87702-H1000	25
163.693	87	Hyundai	87703-H1000	25

	pag	marca	ref.adaptable	U.E.
<b>163.694</b>	87	Hyundai	87770-02000	25
<b>163.695</b>	87	Hyundai	87719-02500	25
<b>163.696</b>	87	Hyundai	87756-2E000	25
<b>163.697</b>	87	Hyundai	87758-39000	25
<b>163.698</b>	87	Hyundai	87759-27000	25
<b>163.699</b>	87	Hyundai	87756-38000	25
<b>163.700</b>	86	Hyundai	82134-22000	25
<b>163.701</b>	86	Hyundai	82852-28000	25
<b>163.702</b>	86	Hyundai	82134-37000	25
<b>163.703</b>	86	Hyundai	82132-27100	25
<b>163.704</b>	86	Hyundai	86438-27100	25
<b>163.705</b>	121	PSA	8123.95	10
<b>163.706</b>	88	Lexus	56116-22050	10
<b>163.706</b>	169	Toyota	56116-22050	10
<b>163.707</b>	186	VAG	3D0 853 576	25
<b>163.708</b>	129	PSA	6991.S9	50
<b>163.709</b>	185	VAG	3D5 853 707 B	10
<b>163.710</b>	185	VAG	1T0 853 910 A	25
<b>163.711</b>	39	BMW	51 13 7 177 926	25
<b>163.712</b>	39	BMW	51 31 7 177 029	10
<b>163.713</b>	121	PSA	8110.25	10
<b>163.714</b>	153	Renault	7701 056 059	25
<b>163.715</b>	132	PSA	9025.J8	50
<b>163.716</b>	126	PSA	8321.26	25
<b>163.717</b>	14	universal		100
	121	PSA	6972.24	100
	134	PSA	6972.24	100
<b>163.718</b>	153	Renault	8200 666 724	10
	153	Renault	8200 369 224	10
<b>163.719</b>	153	Renault	8200 699 857	10
	153	Renault	8200 369 854	10
<b>163.720</b>	143	Renault	7701 070 605	10
<b>163.721</b>	77	Ford	1 029 182	25
	77	Ford	W704453S300	25
<b>163.722</b>	27	universal		25
	78	Ford	6 717 617	25
	78	Ford	W700673S300	25
<b>163.723</b>	118	PSA	7950.59	25
<b>163.724</b>	117	PSA	6990.81	25
<b>163.725</b>	117	PSA	8220.EF	25
<b>163.726</b>	185	VAG	7M3 853 585	25
<b>163.727</b>	101	Mini	51 13 9 804 996	50
	129	PSA	8337.FC	50
<b>163.728</b>	118	PSA	6997.A9	25
<b>163.729</b>	118	PSA	7928.33	10
<b>163.730</b>	133	PSA	8525.NS	25
<b>163.731</b>	132	PSA	7481.GP	10
<b>163.732</b>	109	Opel	01 88 573	10
	109	Opel	90562265	10
<b>163.733</b>	39	BMW	51 31 3 448 374	10
	39	BMW	51 31 3 401 691	10

	pag	marca	ref.adaptable	U.E.
<b>163.734</b>	21	universal		25
	79	Ford	1 028 521	25
	79	Ford	W701054S300	25
<b>163.735</b>	18	universal		25
	79	Ford	1 125 799	25
	79	Ford	1S7X8C162AA	25
<b>163.736</b>	202	VOLVO	1372682	10
<b>163.737</b>	143	Renault	7701 061 133	10
	154	Renault	7701 061 133	10
<b>163.738</b>	180	VAG	6J0 821 120 A	10
	180	VAG	6J0 821 120	10
<b>163.739</b>	180	VAG	6J0 821 119	10
<b>163.740</b>	192	VAG	5J0 867 276	50
<b>163.741</b>	76	Ford	4 097 718	25
	76	Ford	W705364S300	25
<b>163.742</b>	25	universal		25
	78	Ford	6 560 532	25
	78	Ford	W700185S300	25
<b>163.743</b>	19	universal		25
	201	VAG	4D0 807 300	25
<b>163.744</b>	27	universal		25
	78	Ford	4 052 617	25
	78	Ford	W706358S300	25
<b>163.745</b>	44	BMW	51 49 8 166 702	25
<b>163.746</b>	43	BMW	82 11 9 710 191	25
<b>163.747</b>	43	BMW	51 43 8 225 567	25
<b>163.748</b>	41	BMW	51 13 8 231 130	10
<b>163.749</b>	38	BMW	51 13 8 204 858	25
<b>163.750</b>	43	BMW	51 41 8 224 768	25
	101	Mini	51 41 8 224 768	25
<b>163.751</b>	43	BMW	51 41 8 172 050	50
<b>163.752</b>	43	BMW	51 41 8 224 781	25
	101	Mini	51 41 8 224 781	25
<b>163.753</b>	43	BMW	07 14 7 145 753	25
	101	Mini	07 14 7 145 753	25
<b>163.754</b>	76	Ford	1 387 954	25
	76	Ford	W712417S300	25
	101	Mini	07 13 1 503 417	25
<b>163.755</b>	192	VAG	7H0 843 514	25
<b>163.756</b>	22	universal		25
	201	VAG	8K0 868 307	25
<b>163.757</b>	17	universal		25
	200	VAG	8T0 807 300 A	25
<b>163.758</b>	100	Mini	51 36 7 044 616	10
<b>163.759</b>	100	Mini	51 36 7 044 615	10
<b>163.760</b>	195	VAG	6X0 827 951 B	25
<b>163.761</b>	203	VOLVO	9190967	10
<b>163.762</b>	203	VOLVO	9190970	10
<b>163.763</b>	203	VOLVO	9190966	10
<b>163.764</b>	203	VOLVO	6816180	10
<b>163.765</b>	82	Ford	1 216 747	10

	pag	marca	ref.adaptable	U.E.
<b>163.765</b>	82	Ford	W709046S300	10
<b>163.766</b>	74	Ford	1 128 772	10
	74	Ford	W707612S300	10
	11	universal		5
<b>163.767</b>	80	Ford	1 060 382	50
	80	Ford	W703829S300	50
<b>163.768</b>	96	Mercedes	638 690 00 13	10
<b>163.769</b>	30	universal		1
	37	BMW	63 12 0 027 924	1
<b>163.770</b>	42	BMW	51 47 8 234 047	25
	42	BMW	51 47 1 928 808	25
<b>163.771</b>	97	Mercedes	638 988 09 78	25
<b>163.772</b>	40	BMW	51 31 8 150 943	50
<b>163.773</b>	43	BMW	51 41 8 101 204	50
	97	Mercedes	006 988 57 78	50
<b>163.774</b>	41	BMW	51 77 7 166 869	25
<b>163.775</b>	39	BMW	51 13 7 157 702	10
<b>163.776</b>	39	BMW	51 13 7 217 789	10
<b>163.777</b>	39	BMW	51 13 7 184 575	10
<b>163.778</b>	95	Mercedes	001 988 56 81	10
<b>163.779</b>	98	Mercedes	009 997 72 81	10
<b>163.780</b>	21	universal		25
	99	Mercedes	001 990 01 92	25
<b>163.781</b>	95	Mercedes	005 988 72 78	10
<b>163.782</b>	95	Mercedes	001 988 97 81	25
<b>163.783</b>	93	Mercedes	203 690 00 13	10
<b>163.784</b>	93	Mercedes	009 988 16 78	10
<b>163.785</b>	95	Mercedes	011 988 28 78	10
<b>163.786</b>	97	Mercedes	001 988 10 81	25
<b>163.787</b>	97	Mercedes	001 988 09 81	25
<b>163.788</b>	96	Mercedes	631 997 23 86	25
<b>163.789</b>	97	Mercedes	000 990 57 92	50
<b>163.790</b>	97	Mercedes	000 991 04 98	25
<b>163.791</b>	97	Mercedes	000 991 86 98	25
<b>163.792</b>	14	universal		50
	98	Mercedes	124 990 05 92	50
	98	Mercedes	124 990 90 51	50
<b>163.793</b>	14	universal		50
	98	Mercedes	000 990 44 92	50
<b>163.794</b>	19	universal		50
	201	VAG	5P0 810 997	50
<b>163.795</b>	97	Mercedes	163 988 16 78	10
<b>163.796</b>	39	BMW	51 13 7 209 821	10
<b>163.797</b>	39	BMW	51 13 7 238 257	10
<b>163.798</b>	110	Opel	01 64 978	10
	110	Opel	90196277	10
<b>163.799</b>	110	Opel	01 74 853	10
	110	Opel	90376175	10
<b>163.800</b>	109	Opel	01 87 925	10
	109	Opel	73 51 804	10
	109	Opel	93348922	10

	pag	marca	ref.adaptable	U.E.
<b>163.801</b>	38	BMW	51 13 7 117 240	25
	23	universal		10
<b>163.802</b>	85	Honda	91503-SZ5-003	10
	105	Nissan	01553-09321	10
<b>163.803</b>	90	Mazda	D20150797	10
<b>163.804</b>	84	Honda	91513-SM4-000	10
<b>163.805</b>	83	Honda	91560-SP0-003	10
	105	Nissan	80999-VE000	10
<b>163.806</b>	105	Nissan	01553-08371	10
	105	Nissan	01553-07381	10
<b>163.807</b>	105	Nissan	01553-07111	10
	105	Nissan	84953-AU100	10
<b>163.808</b>	64	Fiat	60594191	25
<b>163.809</b>	38	BMW	51 13 7 064 097	10
	15	universal		25
<b>163.810</b>	200	VAG	6L0 121 136	25
<b>163.811</b>	204	VOLVO	8678010	10
<b>163.812</b>	84	Honda	91568-SR2-003	25
<b>163.813</b>	19	universal		10
	85	Honda	90505-SX0-003	10
	23	universal		25
<b>163.814</b>	63	Fiat	71741894	25
	168	Suzuki	09409-15302-000	25
<b>163.815</b>	21	universal		10
	105	Nissan	01553-06721	10
<b>163.816</b>	38	BMW	51 13 7 070 747	10
<b>163.817</b>	38	BMW	51 13 7 073 399	5
<b>163.818</b>	43	BMW	07 14 7 152 593	50
<b>163.819</b>	41	BMW	07 14 6 965 447	25
<b>163.820</b>	42	BMW	51 71 1 927 439	50
<b>163.821</b>	41	BMW	51 77 7 891 250	25
<b>163.822</b>	42	BMW	51 47 8 413 209	25
<b>163.823</b>	43	BMW	51 25 2 753 575	10
	101	Mini	51 25 2 753 575	10
<b>163.824</b>	184	VAG	1K0 837 199 B	25
<b>163.825</b>	42	BMW	51 47 7 117 532	25
<b>163.826</b>	42	BMW	51 33 7 140 714	25
	101	Mini	51 33 7 140 714	25
<b>163.827</b>	18	universal		50
	44	BMW	51 48 1 915 964	50
<b>163.828</b>	42	BMW	51 71 8 259 025	10
<b>163.829</b>	43	BMW	51 41 7 211 653	25
	67	Fiat	50504884	50
<b>163.830</b>	81	Ford	1 580 312	50
	81	Ford	W303562	50
<b>163.831</b>	97	Mercedes	000 991 24 98	25
<b>163.832</b>	103	Mitsubishi	MB-814154	10
<b>163.833</b>	96	Mercedes	638 695 01 14	10
	96	Mercedes	638 695 01 09	10
<b>163.834</b>	193	VAG	1M0 837 720 E	50
<b>163.835</b>	193	VAG	1M0 837 720 F	50

	pag	marca	ref.adaptable	U.E.
<b>163.836</b>	100	Mini	51 13 7 058 122	25
<b>163.837</b>	25	universal		50
	53	Fiat	14591987	50
<b>163.838</b>	203	VOLVO	31304111	10
<b>163.839</b>	203	VOLVO	30753989	10
<b>163.840</b>	42	BMW	51 47 1 840 960	50
<b>163.841</b>	42	BMW	51 47 1 840 961	25
<b>163.842</b>	40	BMW	51 13 1 934 160	50
<b>163.843</b>	43	BMW	51 43 7 001 491	50
	101	Mini	51 43 7 001 491	50
<b>163.844</b>	37	BMW	63 12 1 387 026	10
<b>163.845</b>	101	Mini	07 13 0 561 277	50
<b>163.846</b>	100	Mini	07 13 0 702 516	25
<b>163.847</b>	100	Mini	51 18 8 242 692	25
	42	BMW	51 18 8 242 693	25
<b>163.848</b>	100	Mini	51 18 8 242 693	25
<b>163.849</b>	43	BMW	07 17 7 141 218	25
	101	Mini	07 17 7 141 218	25
<b>163.850</b>	185	VAG	6J0 854 719 C	50
<b>163.851</b>	109	Opel	01 88 582	10
	109	Opel	90580928	10
	53	Fiat	51819230	10
<b>163.852</b>	109	Opel	47 07 662	10
	109	Opel	9216439	10
	168	Suzuki	84618-76G10	10
<b>163.853</b>	94	Mercedes	006 988 75 78	10
<b>163.854</b>	94	Mercedes	006 988 76 78	10
<b>163.855</b>	98	Mercedes	203 997 01 86	1
<b>163.856</b>	98	Mercedes	001 997 95 86	1
<b>163.857</b>	96	Mercedes	000 988 55 81	25
<b>163.858</b>	143	Renault	7701 070 813	25
	155	Renault	7701 070 813	25
	17	universal		10
<b>163.859</b>	169	Toyota	90467-07188	10
	173	Toyota	90467-07188	10
<b>163.860</b>	100	Mini	07 13 2 757 821	25
<b>163.861</b>	97	Mercedes	005 988 82 78	50
<b>163.862</b>	41	BMW	51 71 7 066 223	25
<b>163.863</b>	39	BMW	51 76 7 162 587	25
<b>163.864</b>	101	Mini	51 13 2 754 667	25
<b>163.865</b>	38	BMW	51 13 7 073 396	10
<b>163.866</b>	168	Suzuki	77150-63J10	10
<b>163.867</b>	53	Fiat	1314167080	10
	121	PSA	8120.S6	10
<b>163.868</b>	143	Renault	8200 294 204	10
	143	Renault	8200 048 881	10
<b>163.869</b>	118	PSA	7928.39	25
<b>163.870</b>	127	PSA	8565.62	50
<b>163.871</b>	127	PSA	8123.A9	50
<b>163.872</b>	127	PSA	8565.58	25
<b>163.873</b>	127	PSA	8565.68	25

	pag	marca	ref.adaptable	U.E.
<b>163.874</b>	127	PSA	8565.51	10
<b>163.875</b>	193	VAG	1Z0 837 732 A	50
	110	Opel	12 22 141	25
<b>163.876</b>	110	Opel	24405740	25
	129	PSA	8748.QT	25
	154	Renault	7703 077 477	25
<b>163.877</b>	192	VAG	1K6 837 200 A	25
	25	universal		10
<b>163.878</b>	78	Ford	4 740 548	10
	78	Ford	W709571S300	10
<b>163.879</b>	24	universal		50
	156	Renault	8200 939 873	50
<b>163.880</b>	120	PSA	6986.A8	25
	11	universal		50
<b>163.881</b>	133	PSA	7568.NZ	50
	159	Renault	7700 081 233	50
<b>163.882</b>	11	universal		10
	159	Renault	7703 081 232	10
<b>163.883</b>	12	universal		10
	159	Renault	7703 081 225	10
<b>163.884</b>	187	VAG	3C0 853 586	50
<b>163.885</b>	118	PSA	6995.X2	10
	145	Renault	7703 079 812	10
<b>163.886</b>	26	universal		50
	131	PSA	7568.H0	50
<b>163.887</b>	27	universal		25
	131	PSA	6995.40	25
<b>163.888</b>	118	PSA	7928.31	10
	20	universal		50
<b>163.889</b>	115	Opel	11 04 882	50
	115	Opel	11 04 881	50
	115	Opel	90450482	50
<b>163.890</b>	25	universal		50
	204	VOLVO	1224786	50
<b>163.891</b>	155	Renault	8200 186 255	25
<b>163.892</b>	87	Hyundai	87758-35000	25
<b>163.893</b>	197	VAG	4F0 825 429 A	25
<b>163.894</b>	170	Toyota	90189-06224	25
<b>163.895</b>	169	Toyota	52565-52010	10
<b>163.896</b>	84	Honda	91518-SM4-003	50
<b>163.897</b>	114	Opel	12 35 884	50
	114	Opel	24417039	50
<b>163.898</b>	114	Opel	14 04 969	50
	114	Opel	24449408	50
<b>163.899</b>	110	Opel	22 28 839	25
	110	Opel	24405739	25
<b>163.900</b>	77	Ford	1 097 787	10
	77	Ford	W706236S300	10
<b>163.901</b>	109	Opel	01 87 918	10
	109	Opel	9185662	10
<b>163.902</b>	113	Opel	22 40 861	50

	pag	marca	ref.adaptable	U.E.
<b>163.902</b>	113	Opel	90022049	50
	23	universal		50
<b>163.903</b>	201	VAG	6J0 821 213	50
	204	VOLVO	30817220	50
<b>163.904</b>	104	Nissan	66820-9F900	25
<b>163.905</b>	128	PSA	9341.23	10
<b>163.906</b>	46	Dacia	7703 081 227	25
	157	Renault	7703 081 227	25
<b>163.907</b>	98	Mercedes	002 988 51 81	25
<b>163.908</b>	93	Mercedes	204 690 06 14	10
<b>163.909</b>	93	Mercedes	011 988 94 78	10
	14	universal		50
<b>163.910</b>	115	Opel	22 65 571	50
	115	Opel	90467391	50
<b>163.911</b>	111	Opel	01 74 611	50
	111	Opel	01 29 943	50
	111	Opel	90580707	50
<b>163.912</b>	121	PSA	6823.54	50
<b>163.913</b>	120	PSA	6555.N7	25
	145	Renault	8200 222 830	25
<b>163.914</b>	77	Ford	1 041 646	10
	77	Ford	97KB17N800AE	10
<b>163.915</b>	73	Ford	1 023 253	10
	73	Ford	95VWA03836CA	10
<b>163.916</b>	114	Opel	11 90 970	25
	114	Opel	90053803	25
<b>163.917</b>	186	VAG	3C0 853 585	25
	20	universal		25
<b>163.918</b>	79	Ford	1 639 908	25
	79	Ford	8A61A02737AA	25
<b>163.919</b>	113	Opel	11 62 742	50
	113	Opel	13265959	50
<b>163.920</b>	53	Fiat	60697869	10
	121	PSA	8745.66	10
<b>163.921</b>	80	Ford	1 073 073	50
	80	Ford	W706006S300	50
<b>163.922</b>	19	universal		50
	44	BMW	07 14 7 136 172	50
<b>163.923</b>	19	universal		50
	44	BMW	51 49 8 237 075	50
<b>163.924</b>	22	universal		25
	99	Mercedes	163 990 02 92	25
<b>163.925</b>	22	universal		50
	99	Mercedes	123 990 00 92	50
<b>163.926</b>	14	universal		50
	98	Mercedes	000 990 22 92	50
<b>163.927</b>	99	Mercedes	000 990 37 92	50
<b>163.928</b>	42	BMW	51 47 8 244 458	50
<b>163.929</b>	186	VAG	8R0 853 909 A	25
	186	VAG	8R0 853 909	25
<b>163.930</b>	109	Opel	01 88 551	10

	pag	marca	ref.adaptable	U.E.
<b>163.930</b>	109	Opel	9114735	10
<b>163.931</b>	170	Toyota	75397-35010	10
<b>163.932</b>	170	Toyota	75498-42010	10
<b>163.933</b>	170	Toyota	75392-60031	10
<b>163.934</b>	170	Toyota	75495-35010	10
<b>163.935</b>	170	Toyota	75394-60030	10
<b>163.936</b>	170	Toyota	75492-60020	10
<b>163.937</b>	170	Toyota	75881-60010	10
<b>163.938</b>	170	Toyota	75883-60010	10
<b>163.939</b>	170	Toyota	75882-60010	10
<b>163.940</b>	170	Toyota	75884-60010	10
<b>163.941</b>	170	Toyota	90904-67037	10
<b>163.942</b>	170	Toyota	90904-67036	10
<b>163.943</b>	93	Mercedes	000 991 58 71	10
<b>163.944</b>	127	PSA	8742.Q6	25
<b>163.945</b>	26	universal		50
<b>163.945</b>	66	Fiat	718115080	50
<b>163.946</b>	56	Fiat	51786776	1
<b>163.947</b>	56	Fiat	51786777	1
<b>163.948</b>	143	Renault	8201 111 623	10
<b>163.949</b>	38	BMW	51 13 2 992 450	25
<b>163.950</b>	38	BMW	51 33 7 052 945	25
<b>163.951</b>	38	BMW	51 71 7 006 757	25
<b>163.952</b>	39	BMW	51 13 7 232 420	10
<b>163.953</b>	142	Renault	7701 064 619	10
<b>163.954</b>	192	VAG	4F0 831 719	25
<b>163.955</b>	186	VAG	3B0 867 333	25
<b>163.956</b>	186	VAG	3B0 867 334	25
<b>163.957</b>	83	Honda	91570-SJD-003	10
<b>163.958</b>	203	VOLVO	8622906	10
<b>163.959</b>	143	Renault	7701 367 683	1
	76	Ford	1 144 718	25
	76	Ford	W708355S300	25
<b>163.961</b>	15	universal		50
	200	VAG	N10417901	50
<b>163.962</b>	87	Hyundai	82315-38000	25
	87	Hyundai	82315-27000	25
	87	Hyundai	82315-33010	25
	87	Hyundai	82315-33020	25
<b>163.963</b>	22	universal		25
	63	Fiat	1357450080	25
	135	PSA	7813.29	25
<b>163.964</b>	27	universal		25
	66	Fiat	735493588	25
<b>163.965</b>	65	Fiat	51831913	50
<b>163.966</b>	69	Fiat	51721582	25
<b>163.967</b>	65	Fiat	71748293	50
<b>163.968</b>	65	Fiat	735500166	25
<b>163.969</b>	26	universal		25
	66	Fiat	7352905437	25
<b>163.970</b>	67	Fiat	60502080	25

	pag	marca	ref.adaptable	U.E.
<b>163.971</b>	27	universal		25
	66	Fiat	14589887	25
<b>163.972</b>	27	universal		25
	66	Fiat	735430175	25
<b>163.973</b>	23	universal		10
	63	Fiat	51780607	10
<b>163.974</b>	196	VAG	6J0 867 276	25
<b>163.975</b>	199	VAG	4G0 827 310	25
<b>163.976</b>	86	Hyundai	81126-37010	25
<b>163.977</b>	103	Mitsubishi	MB-814152	10
<b>163.978</b>	143	Renault	76 8E 608 98R	1
<b>163.979</b>	121	PSA	8321.31	10
<b>163.980</b>	126	PSA	8321.43	10
	22	universal		10
	89	Lexus	90467-09128	10
<b>163.981</b>	135	PSA	6822N7	10
	173	Toyota	90467-09128	10
164.378	162	Seat		10
164.379	178	VAG	1H0 823 499	5
	52	Fiat	4276430	5
164.381	120	PSA		10
	144	Renault		10
164.382	52	Fiat	7787498	5
164.383	178	VAG	1H0 823 500 B	5
164.384	178	VAG	6N0 827 499	1
164.385	120	PSA	7908.67	10
<b>164.386</b>	144	Renault	7700 843 546	5
<b>164.387</b>	120	PSA	8733.75	10
<b>164.388</b>	120	PSA	8733.88	5
<b>164.389</b>	120	PSA	8733.89	5
<b>164.390</b>	120	PSA	7908.F6	5
164.685	70	Ford	1 077 106	10
	70	Ford	W706160S309	10
164.694	2	universal		25
164.695	2	universal		25
<b>171.433</b>	31	universal		1
	123	PSA	6224.L1	1
<b>171.434</b>	31	universal		1
	58	Fiat	9632162280	1
	123	PSA	6224.C0	1
<b>173.041</b>	31	universal		1
	37	BMW	63 11 6 938 563	1
	31	universal		1
	58	Fiat	42536208	1
<b>173.080</b>	74	Ford	1 041 664	1
	74	Ford	95VW13K193CA	1
	167	Smart		1
	183	VAG	1J0 941 295 A	1
<b>173.196</b>	31	universal		1
	183	VAG	1J0 941 295 B	1
<b>173.197</b>	31	universal		1

	pag	marca	ref.adaptable	U.E.
<b>173.197</b>	112	Opel	62 07 109	1
	112	Opel	13142042	1
	183	VAG	1K6 941 295	1
<b>175.224</b>	31	universal		1
	147	Renault	8200 402 521	1
<b>175.225</b>	31	universal		1
	147	Renault	8200 261 818	1
<b>175.226</b>	31	universal		1
	147	Renault	8200 501 939	1
<b>176.213</b>	31	universal		1
	104	Nissan	286056-AU300	1
<b>178.098</b>	31	universal		1
	112	Opel	12 07 203	1
	112	Opel	13129840	1
	183	VAG	5P0 941 295	1
<b>180.501</b>	35	universal		1
<b>180.512</b>	35	universal		1
<b>181.400</b>	164	Seat	4483981	1
<b>181.401</b>	164	Seat	4255534	1
<b>181.403</b>	162	Seat		1
<b>181.404</b>	82	Ford	1 648 812	1
	82	Ford	87BBA46812AYYB7	1
<b>181.405</b>	178	VAG	191 863 447	1
	178	VAG	1H6863447B41	1
<b>181.410</b>	178	VAG		1
<b>181.413</b>	52	Fiat	7671135	1
<b>181.416</b>	52	Fiat	60812237	1
<b>181.417</b>	107	Opel		10
<b>181.425</b>	191	VAG	6K3 837 223	10
<b>181.426</b>	191	VAG	1H0 837 223 B	10
<b>181.427</b>	191	VAG	6K4 837 223	10
<b>181.428</b>	191	VAG	6K4 837 223 A	10
<b>181.429</b>	191	VAG	6K3 837 223 A	10
<b>181.431</b>	164	Seat	SE-021521358A	1
<b>181.432</b>	164	Seat	SE-021521358B	1
<b>181.433</b>	164	Seat	SE-021521359A	1
<b>181.434</b>	164	Seat	SE-021522358A	1
<b>181.435</b>	164	Seat	SE-021522359A	1
<b>181.440</b>	191	VAG	6N0 837 223 A	10
<b>181.441</b>	191	VAG	7M0 837 223 A	10
<b>181.442</b>	191	VAG		10
<b>181.591</b>	191	VAG		1
<b>181.592</b>	191	VAG		1
<b>181.593</b>	191	VAG		1
<b>181.594</b>	191	VAG		1
<b>181.595</b>	191	VAG	1U0 837 167 E	1
	191	VAG	1U0 837 167 C	1
<b>182.308</b>	120	PSA		1
<b>182.310</b>	144	Renault		1
<b>182.312</b>	52	Fiat	7740229	1
<b>182.314</b>	144	Renault		1

	pag	marca	ref.adaptable	U.E.
<b>184.866</b>	60	Fiat	4941207	1
<b>184.867</b>	52	Fiat		1
<b>184.868</b>	52	Fiat	7561909	1
<b>184.870</b>	164	Seat		1
<b>184.871</b>	164	Seat		1
<b>184.872</b>	164	Seat		1
<b>184.873</b>	164	Seat		1
<b>184.874</b>	164	Seat		1
<b>188.007</b>	28	universal		2
<b>188.054</b>	28	universal		2
<b>190.001</b>	54	Fiat	60503854	5
<b>190.002</b>	54	Fiat	5942690	5
<b>190.003</b>	54	Fiat	7641846	5
<b>190.004</b>	54	Fiat	7586380	5
<b>190.005</b>	54	Fiat	7679491	5
<b>190.006</b>	54	Fiat	7769348	5
<b>190.007</b>	72	Ford	6 163 974	5
<b>190.007</b>	72	Ford	89FG-17666-AA	5
<b>190.008</b>	72	Ford	96 FG 17666 AA	5
<b>190.009</b>	54	Fiat	4389370	5
<b>190.010</b>	108	Opel	14 51 166	5
	108	Opel	90087621	5
<b>190.011</b>	108	Opel	14 51 181	5
	108	Opel	90356178	5
<b>190.012</b>	108	Opel	14 51 174	5
	108	Opel	9197915	5
<b>190.013</b>	108	Opel	14 51 183	5
	108	Opel	90360289	5
<b>190.016</b>	140	Renault	7700 763 006	5
<b>190.017</b>	140	Renault	7700 795 778	5
<b>190.018</b>	140	Renault	7700 784 411	5
<b>190.019</b>	140	Renault	7700 728 108	5
<b>190.020</b>	140	Renault	7700 821 295	5
<b>190.021</b>	162	Seat	4400321	5
<b>190.022</b>	162	Seat	4432041	5
<b>190.025</b>	118	PSA	6438.71	5
<b>190.026</b>	118	PSA	6438.A0	5
	118	PSA	96084939	5
<b>190.027</b>	54	Fiat	7767818	5
<b>190.028</b>	54	Fiat	182036080	5
<b>190.029</b>	54	Fiat	735277664	5
<b>190.030</b>	140	Renault	7700 823 915	5
<b>190.031</b>	178	VAG	191 955 985 A	5
<b>190.032</b>	140	Renault	7700 413 545	5
<b>190.033</b>	54	Fiat	1301155080	5
<b>190.034</b>	118	PSA	6438.F1	5
<b>190.035</b>	118	PSA	6438.89	5
<b>190.036</b>	140	Renault	7700 308 815	5
<b>190.037</b>	54	Fiat	46765852	5
<b>190.038</b>	54	Fiat	735360838	5
<b>190.039</b>	55	Fiat	51702444	5

	pag	marca	ref.adaptable	U.E.
<b>190.040</b>	55	Fiat	71728628	2
<b>190.041</b>	118	PSA	6405.W3	5
<b>190.041</b>	169	Toyota		5
<b>190.042</b>	118	PSA	6438.P4	5
<b>190.043</b>	118	PSA	6438.97	2
<b>190.045</b>	118	PSA	6438.F2	2
<b>190.046</b>	55	Fiat	7687086	2
<b>190.047</b>	55	Fiat	735274992	5
<b>190.048</b>	55	Fiat	46821846	5
<b>190.049</b>	55	Fiat	46847980	5
	55	Fiat	500327004	5
<b>190.050</b>	55	Fiat	735354534	2
<b>190.051</b>	55	Fiat	735337771	5
<b>190.052</b>	55	Fiat	735311599	5
<b>190.053</b>	55	Fiat	735316328	5
<b>190.054</b>	55	Fiat	735322933	5
<b>190.055</b>	55	Fiat	735306873	2
<b>190.057</b>	118	PSA	6438.67	2
<b>190.058</b>	140	Renault		2
<b>190.059</b>	140	Renault	7701 206 590	2
<b>190.060</b>	140	Renault	7700 838 380	2
<b>190.061</b>	140	Renault	7701 206 591	2
<b>190.062</b>	140	Renault	8200 082 347	5
<b>190.063</b>	140	Renault	7700 846 208	2
<b>190.064</b>	140	Renault	7700 846 317	2
<b>190.065</b>	102	Mini	61 66 7 146 377	2
<b>190.066</b>	102	Mini	61 66 7 146 378	2
<b>190.067</b>	102	Mini	61 66 2 756 194	2
<b>190.068</b>	102	Mini	61 66 2 755 722	2
<b>190.069</b>	72	Ford	1 442 176	5
	72	Ford	2N11-17666-AD	5
<b>190.070</b>	72	Ford	1 404 820	5
	72	Ford	3M51-17666-AD	5
<b>190.071</b>	72	Ford	1 077 453	5
	72	Ford	98KG-17666-AA	5
<b>190.351</b>	32	universal		1
	53	Fiat	71719636	1
<b>190.352</b>	53	Fiat	7688208	1
	32	universal		1
<b>190.352</b>	92	Mercedes	202 869 00 21	1
	179	VAG	431 955 651	1
<b>190.353</b>	32	universal		1
	37	BMW		1
	92	Mercedes	210 869 10 21	1
<b>190.354</b>	179	VAG	1J6 955 651	1
	32	universal		1
<b>190.355</b>	179	VAG	4A0 955 651 A	1
	32	universal		1
	37	BMW	67 12 8 362 154	1
<b>190.355</b>	92	Mercedes	202 869 02 21	1
	167	Smart		1

	pag	marca	ref.adaptable	U.E.
190.355	179	VAG	1K5 955 651	1
190.356	32	universal		1
	37	BMW	61 66 1 380 068	1
190.357	32	universal		1
	119	PSA	6434.46	1
190.358	119	PSA	6434.66	1
	32	universal		1
190.359	53	Fiat	9601120180	1
	119	PSA	6434.58	1
190.360	32	universal		1
	72	Ford	1 355 124	1
	72	Ford	1 514 079	1
	72	Ford	1S7117K624FE	1
	202	VOLVO	31283805	1
190.361	32	universal		1
	53	Fiat	9612358180	1
	119	PSA	6434.60	1
190.362	32	universal		1
	119	PSA	6434.75	1
190.363	141	Renault	7700 428 386	1
	32	universal		1
	83	Honda	76806-SH3-003	1
	83	Honda	76806-SV5-A02	1
	86	Hyundai	98510-29600	1
	90	Mazda	LA01-67-482	1
	103	Mitsubishi	MR-155254	1
167	Subaru	8533012320	1	
190.364	168	Suzuki		1
	169	Toyota	85310-22080	1
	32	universal		1
	53	Fiat	46797755	1
	53	Fiat	7682336	1
	108	Opel	14 50 175	1
190.365	108	Opel	90492357	1
	32	universal		1
	47	Daewoo	38410-66113	1
	72	Ford	6 140 949	1
	72	Ford	83BB17K624AA	1
	83	Honda	75806- SN7-E05	1
	86	Hyundai	98510-3B000	1
103	Mitsubishi	MB-358361	1	
190.366	168	Suzuki	38410-66113	1
	169	Toyota	38410-66113	1
	32	universal		1
	72	Ford	7 003 177	1
190.367	72	Ford	93BB17K624AA	1
	32	universal		1
190.368	72	Ford	7 003 178	1
	72	Ford	93BB17K624BA	1

	pag	marca	ref.adaptable	U.E.
190.368	32	universal		1
	72	Ford	7 222 079	1
	72	Ford	95VW17K624AA	1
	108	Opel		1
190.369	179	VAG	1H6 955 651	1
	32	universal		1
190.370	161	Rover		1
	32	universal		1
190.371	92	Mercedes	140 869 02 21	1
	92	Mercedes	202 869 01 21	1
190.372	32	universal		1
	92	Mercedes	129 869 00 21	1
	108	Opel	14 50 156	1
190.373	179	VAG		1
	33	universal		1
	108	Opel	14 50 173	1
190.374	108	Opel	14 50 185	1
	179	VAG		1
190.375	33	universal		1
	108	Opel	14 50 184	1
190.376	108	Opel	90585761	1
	33	universal		1
190.377	141	Renault	7700 430 702	1
	33	universal		1
190.378	141	Renault	7701 048 307	1
	33	universal		1
190.379	119	PSA	6434.70	1
	141	Renault	7700 431 079	1
	33	universal		1
190.380	141	Renault	7700 802 336	1
	33	universal		1
	92	Mercedes	204 866 02 21	1
190.381	102	Mini	67 12 8 377 987	1
	179	VAG	1L0 955 651	1
	33	universal		1
190.382	179	VAG	1K5 955 651	1
	202	VOLVO	9178094	1
	33	universal		1
	202	VOLVO	9169611	1
190.383	33	universal		1
	37	BMW	67 12 8 360 244	1
	33	universal		1
190.384	37	BMW	67 12 6 973 097	1
	72	Ford	1 209 387	1
	183	VAG	3B7 955 681	1
190.385	33	universal		1
	53	Fiat		1
190.386	119	PSA	6434.67	1
	33	universal		1
190.387	33	universal		1
	141	Renault	7704 002 215	1
190.388	33	universal		1
	45	Dacia	6001 549 443	1
	104	Nissan	28920-BU010	1
	119	PSA	6434.76	1
190.389	141	Renault	7700 428 390	1
	33	universal		1
190.390	108	Opel		1
	33	universal		1
190.501	34	universal		10
190.502	34	universal		10
190.503	34	universal		10
190.504	34	universal		10
190.505	34	universal		10
190.506	34	universal		10
190.507	34	universal		10
190.508	34	universal		10
190.509	34	universal		10
190.510	34	universal		10
190.511	34	universal		10
190.512	34	universal		10
190.513	34	universal		10
190.514	34	universal		10
190.515	34	universal		10
190.516	34	universal		10
190.517	34	universal		10
190.518	34	universal		10
190.519	34	universal		10
301.021	29	universal		50
301.022	199	VAG		50
	29	universal		50
301.447	199	VAG	6K0 971 898 D	50
	29	universal		100
301.448	29	universal		100
301.449	29	universal		100
301.450	29	universal		100
301.452	29	universal		100
301.453	29	universal		100
301.454	29	universal		100
301.455	29	universal		100
301.456	29	universal		100
301.457	29	universal		100
301.458	29	universal		100
301.459	29	universal		100
301.460	29	universal		100



# INDICE - ref. EUROCODE

EUROCODE		pag	ORIGINAL	EUROCODE		pag	ORIGINAL	EUROCODE		pag	ORIGINAL
2037ASCHB	163808	64	60594191	3936ASCSS6B	163132	83	91525SM4003	7239LSCHFD	162727	148	7700784690
2426ASCS	162945	39	51311938494	3940ASCS	163123	83	91520SR3003	7247ASCV	163425	142	8200333033
2426ASCSB	163128	44	51218205295	3943ASCHB	162947	161	DCC10010	7248ASCH	162999	142	7700838570
2427ASCS	162945	39	51318177850	3948ASCC	163124	83	91515SR3000	7250ASCHS1B	163868	143	8200294204
2427ASCSB	163056	39	51711928946	3948ASCCTS7B	163123	161	91520SR3002	7251ASCVB	163670	143	7701056146
2431ASCSB	163125	44	51718195811	3948ASCS	163123	161	91520SR3003	7261AKCC1F	163595	143	7701057073
2431ASCSB7B	163078	39	51718108613	3954ASCH	163131	83	91511ST3E00	7261ASCC	163595	143	7701057073
2431LSGSFD	163055	40	51321938884	3992ASCV2B	163957	83	91570SJD003	7261ASCC6B	163737	143	7701061133
2433ASCS	163058	39	51318125892	5117ASCS	163507	90	HA0150609A	7262ASCHS	163673	143	7701062542
2433ASCSB	163125	44	51718195811	5328ASCST	162730	93	2016980160	7262ASCHS1B	163674	143	8200335703
2434ASCSB	163128	44	51218205295	5328ASCST1B	162731	93	2016980660	7280AKCMS2F	163978	143	768E60898R
2434ASSH	163128	44	51218205295	5337ASCST	163461	93	2106900213	7603ASCH	162689	185	191853733A
2435ASCSB	163125	44	51718195811	5347ASCS	163909	93	0119889478	7603ASCS	162689	185	191853733A
2440ASCHB	163651	100	07131490537	5347ASCSB	163462	93	2119880081	7608ASCSS	162990	185	1M0854541A
2440ASCHB1B	163652	100	51317046633	5352ASCCD	163783	93	2036900013	7608ASCSS1B	162991	185	1M0854719A
2440ASCHB2B	163653	100	51317111933	5358ASCHDS	163943	93	0009915871	7610LSCHRQ	163545	185	6L6853575
2445ASCSS	163456	39	51317064098	5358BSCH	163831	97	0009912498	7613ASCHS	163637	185	1P0854719B
2447ASCSS	163347	39	51137145109	5364ASCSDS	163908	93	2046900614	7614ASCHS	163850	185	6J0854719C
2447ASCSS1B	163348	39	51137172103	5364ASSSB	163640	93	1239900592	7811ASCMS	162370	185	5J0853573
2447ASCSS2B	163349	39	51137145110	5428ASCVR	163537	93	6389840961	7915ASCHS	163479	167	91017FA010
2449ASCRES	163733	39	51313448374	5428ASCVS	162919	93	6389840361	8011ASCH	163300	168	09409073085PK
2452ASCRES	163711	39	51137177926	5641ASCHS	163832	103	MB814154	8031ASCHS	163866	168	7715063J10
2452ASCRES2B	163712	39	51317177029	5642ASCHS	163977	103	MB814152	8262ASCH	163130	169	7554820110
2455ASCHD	163836	100	51137058122	5981ASCS	163904	104	668209F900	8305ASCH6B	163859	169	9046707188
2457ASCSDS	163775	39	51137157702	6283ASCH	163345	109	0188581	8310ASCH	163359	169	5611530100
2457ASCSDS1B	163776	39	51137217789	6283ASCVS	163345	109	0188581	8310ASCH6B	163706	169	5611622050
2459ASCSDS	163796	39	51137209821	6284ASCH1T	162938	109	0188577	8371ASCSS	163650	88	7554553010
2718ASCHB	162633	128	699502	6284ASCHD	163732	109	0188573	8541ASCH	162690	185	1H0853733B
2719ASCH	163316	121	812370	6284ASCHS	162937	109	0188550	8541ASCHB	162765	185	1H0819055C
2725ASCHB	162978	128	6995S0	6290ASCH	163899	110	2228839	8541ASCHB1	162759	185	1H0819055B
2730ASCTS1B	163082	121	6991S6	6291ASCV	163852	109	4707662	8556LSCSFD	162946	193	3B0868243
2731ASCHS	163312	121	812388	6300ASCVB	162826	111	4414667	8568LSCHFD	163541	193	6Q0868243
2732ASSHS	161606	116	697305	6300ASCVBK	163140	115	4414666	8572LSCSFD1B	163468	193	8E0868243
2733ASCSS	163705	121	812395	6302ASCHB	163431	109	5104988	8579SSCVFD	163470	193	7L6868243
2735ASCMS	163379	121	812396	6520ASMH	163645	121	812368	8812ASC6B	163360	202	1325285
2740ASCSS	163672	121	812398	6539ASCHB	162967	121	856540	8824ASCES	163337	202	30873201
3355ASCHB	163837	53	14591987	6539ASCHS	163717	121	697224	8824ASC6B	163336	202	30800958
3359ASCH6B	162965	53	51218205295	6539ASSHB	163014	135	781324	8824ASC7B	163337	202	30873201
3363ASCR	163248	168	7755365D00	6544ASCSS	163313	121	812389	8824ASCSB	163647	203	30872551
3539ASCHS	162812	73	6114021	6544ASCSS1B	163314	121	812390	8824ASCSS	163336	202	30800958
3546ASCHB	163613	73	6781549	6544ASCSS2B	163315	121	812391	8824ASCST	163335	202	30800957
3546ASCHB1B	163023	73	6781550	6547ASCHS	163373	121	811024	8824ASDS	163643	203	30874958
3546ASSH	163023	73	6781550	6558LSCVFD	163594	121	9341PF	8828ASCS	163761	203	9190967
3550ASCVB	163726	185	7M3853585	6560ASCMS1B	163713	121	811025	8828ASC7B	163762	203	9190970
3550ASCVS	163915	73	1023253	7020ASCSS4B	163036	161	91508SM4003	8828ASC6B	163198	204	1268176
3550SSCVFDX	162847	192	7M0867299K	7024ASCR	163333	161	DCE10038L	8828ASCSS	163763	203	9190966
3554ASCH	163133	73	1022510	7033ASCRES	163639	161	DYC500020	8828BSCSS	163764	203	6816180
3556ASCHB	163018	73	1106903	7231ASFH	163310	142	7700789274	8829ASCES	163334	202	30678009
3731ASCSB	162812	73	6114021	7231LSCHFDS	162306	148	7700838242	8829ASCES1B	163199	202	9190981
3739ASCV	163022	73	4494056	7232ASCH	163310	142	7700789274	8829ASCES2B	163958	203	8622906
3739ASCV1	163021	73	4069906	7236ASFH	163321	142		8829ASCSS	163334	183	30678009
3936ASCHB	163036	85	91508SM4003	7237AKCH	193959	143	7701367683	8832ASC6B	163644	203	30864984